

中華民國101年度
臺北市稅捐統計年報

YEARBOOK OF MUNICIPAL TAX
STATISTICS OF TAIPEI CITY
2012



臺北市稅捐稽徵處
TAIPEI CITY **R**EVENUE **S**ERVICE
102年3月編製

編 製 說 明

- 一、本刊之編製，旨在提供本處稽徵業務執行與成果資料，以為公務計畫、執行、考核及財務管理上之參考。
- 二、本刊資料內容包括稅收概況、稅收統計、稅源及其他、行政組織等 4 大項。
- 三、本刊所稱「年度」係指政府會計年度，採曆年制(當年 1 月 1 日至同年 12 月 31 日)。
- 四、本刊數字因尾數四捨五入，故部分總數與細項之間，或有未能吻合情事，計算時仍以原始數據計算。
- 五、本刊所有符號「—」表示無數值，「--」表示無意義數值，「…」表示數值不明或尚未產生資料，「0」表示有數值而不及半單位，數字前加(-)者表示退稅或減免數，(+)者表示增加數。

目 次

壹、稅收概況

一、101 年度稅收概況	2
二、近 10 年稅收	3
三、地價稅	4
四、土地增值稅	5
五、房屋稅	6
六、使用牌照稅	7
七、契稅	8
八、印花稅	9
九、娛樂稅	10

貳、稅收統計

表 1 各項稅捐徵績比較	12
表 2 歷年各項稅捐預算數、查定數與實徵數	
(一)總計	14
(二)稅課收入	
1. 合計	16
2. 地價稅	18
3. 土地增值稅	20
4. 房屋稅	22
5. 使用牌照稅	24
6. 契稅	26
7. 印花稅	28
8. 娛樂稅	30

CONTENTS

I. Analysis of Revenues from Taxes

A. Tax Revenues in 2012	2
B. Tax Revenues in Nearly 10 Years.....	3
C. Land Value Tax.....	4
D. Land Value Increment Tax.....	5
E. House Tax.....	6
F. Vehicle License Tax.....	7
G. Deed Tax	8
H. Stamp Tax.....	9
I. Amusement Tax.....	10

II. Tax Revenue Statistics

Table 1. Net Tax Revenues Compare	12
Table 2. Budget Amount, Audited Amount and Actual Collection in Recent Years	
(I) Grand Total.....	14
(II) Revenues from Taxes	
1. Total	16
2. Land Value Tax	18
3. Land Value Increment Tax	20
4. House Tax	22
5. Vehicle License Tax	24
6. Deed Tax	26
7. Stamp Tax	28
8. Amusement Tax	30

9. 九年國民義務教育附徵教育經費

(1)小計	32
(2)房屋稅	34
(3)娛樂稅	36
(三)工程受益費	38
(四)罰鍰收入	40
(五)規費收入	42
表 3 各項稅捐納庫數	
(一)歷年別	44
(二)稅目別	46
表 4 歷年各項稅捐實徵淨額及指數	48
表 5 本處各項稅捐稽徵成本	52

參、稅源及其他

表 6 地價稅稅源	54
表 7 土地增值稅稅源	56
表 8 房屋稅稅源	58
表 9 使用牌照稅稅源	62
表 10 契稅稅源	64
表 11 印花稅稅源	66
表 12 娛樂稅稅源	68
表 13 違章漏稅案件處理及財務罰鍰執行情形表	72
表 14 各項稅捐滯納案件移送執行情形	76
表 15 查(核)定開徵數及未徵數情形	78

9. Education Surtax	
(1) Subtotal	32
(2) House Tax.....	34
(3) Amusement Tax.....	36
(III) Construction Benefit Fee.....	38
(IV) Punitive Fine Revenue.....	40
(V) Fees Revenue.....	42
Table 3. Taxation Forwarded to Treasury	
(I) Fiscal Year	44
(II) Item of Tax	46
Table 4. Net Amount Remitted and Index in Recent Years	48
Table 5. Cost of Tax Levying	52

III. Tax Sources and Others

Table 6. Sources of Land Value Tax.....	54
Table 7. Sources of Land Value Increment Tax.....	56
Table 8. Sources of House Tax.....	58
Table 9. Sources of Vehicle License Tax.....	62
Table 10. Sources of Deed Tax.....	64
Table 11. Sources of Stamp Tax.....	66
Table 12. Sources of Amusement Tax	68
Table 13. The Management of Cases of Tax Evasion Against Law and Execution Status of Fine	72
Table 14. The Status of Delayed Case Transferred to Execution.....	76
Table 15. The Management of Opening Collection for Assessed(Verified) and of Tax Not Collected	78

表 16 各項稅捐現行稅率表	86
表 17 各項稅捐劃解分配率	93
表 18 本處各項稅捐稽徵工作流程圖	
(一)地價稅	94
(二)土地增值稅	95
(三)房屋稅	96
(四)使用牌照稅	97
(五)契稅	98
(六)印花稅	99
(七)娛樂稅	100
(八)支票退稅	101

肆、行政組織

一、沿革 (附圖)	105
二、組織 (附圖)	107
三、人事 (附圖)	109
表 19 本處人事概況	
(一)法定員額與現有員額	110
(二)年齡與職等、性別	112
(三)學歷及考試	112
(四)年資	113
(五)工作類別	113
表 20 本處歲出預決算數	114

Table 16. Current Tax Rates for Taxation	86
Table 17. The Distribution Rates of Tax	93
Table 18. Work Flow Chart	
(I) Land Value Tax.....	94
(II) Land Value Increment Tax	95
(III) House Tax	96
(IV) Vehicle License Tax	97
(V) Deed Tax	98
(VI) Stamp Tax.....	99
(VII) Amusement Tax.....	100
(VIII) Check Refund.....	101

IV. Administrative Organization

A. The History.....	105
B. Organization	107
C. Personnel	109
Table 19. Personnel Statistic	
(I) Personnel Management & Present Personnel.....	110
(II) By Age & Official Class & Sex	112
(III) By Educational Attainment & Recruitment Way	112
(IV) By Length of Service	113
(V) Work Type.....	113
Table 20. Budget and Closed Account of Expenditures	114

壹、稅收概況

I . Analysis of Revenues from Taxes

一、101 年度稅收概況

101 年度本市地方稅稅收實徵淨額 621.89 億元，較預算數 610.5 億元，超徵 11.39 億元，年度預算達成率 101.9%，除土地增值稅與契稅因房市受特種貨物及勞務稅與實價登錄等影響，分別短徵 6.03 億元及 6.69 億元外，其餘各稅均超徵，其中地價稅因清查成績顯著及加強欠稅清理，實徵 206.7 億元，超徵 11.7 億元最多，其次是房屋稅因實施高級住宅加價課稅及調整路段率，實徵 118.6 億元，超徵 4.6 億元，餘印花稅、使用牌照稅與娛樂稅，分別超徵 3.79 億元、3.78 億元及 0.24 億元。

101 年度地方稅稅課收入

單位：新臺幣億元

項目 稅目	預算數 (1)	實徵淨額 (2)	超(短)徵		預算達成率 (5)=(2)/(1)*100
			金額 (3)=(2)-(1)	百分比 (4)=(3)/(1)	
稅課收入	610.50	621.89	11.39	1.9%	101.9%
地價稅	195.00	206.70	11.70	6.0%	106.0%
土地增值稅	170.00	163.97	-6.03	-3.5%	96.5%
房屋稅	114.00	118.60	4.60	4.0%	104.0%
使用牌照稅	64.50	68.28	3.78	5.9%	105.9%
契稅	24.00	17.31	-6.69	-27.9%	72.1%
印花稅	41.00	44.79	3.79	9.2%	109.2%
娛樂稅	2.00	2.24	0.24	12.1%	112.1%
教育經費	—	0.00	0.00	--	--

101 年度各稅比重

實徵淨額總計 621.89 億元

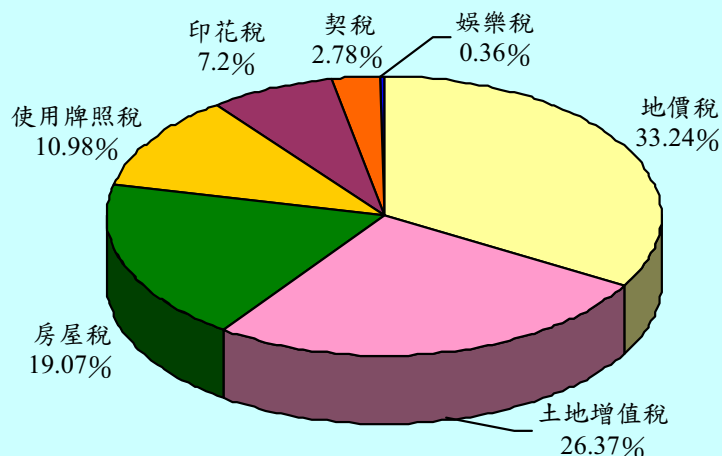

二、近 10 年稅收

近 10 年稅課收入統計表

單位：新臺幣億元

年度別	預算數	實徵淨額	超(短)徵		實徵淨額與上年度增減比較	
			金額	百分比	金額	百分比
92	545.08	520.08	-25.00	-4.6%	--	--
93	450.15	578.61	128.46	28.5%	58.53	11.3%
94	497.93	603.32	105.39	21.2%	24.71	4.3%
95	518.28	593.34	75.06	14.5%	-9.98	-1.7%
96	530.93	616.96	86.03	16.2%	23.62	4.0%
97	540.34	565.71	25.37	4.7%	-51.25	-8.3%
98	535.20	573.45	38.25	7.1%	7.74	1.4%
99	527.10	608.45	81.35	15.4%	35.00	6.1%
100	562.68	619.99	57.31	10.2%	11.54	1.9%
101	610.50	621.89	11.39	1.9%	1.90	0.3%

近 10 年稅課收入預算數與實徵淨額

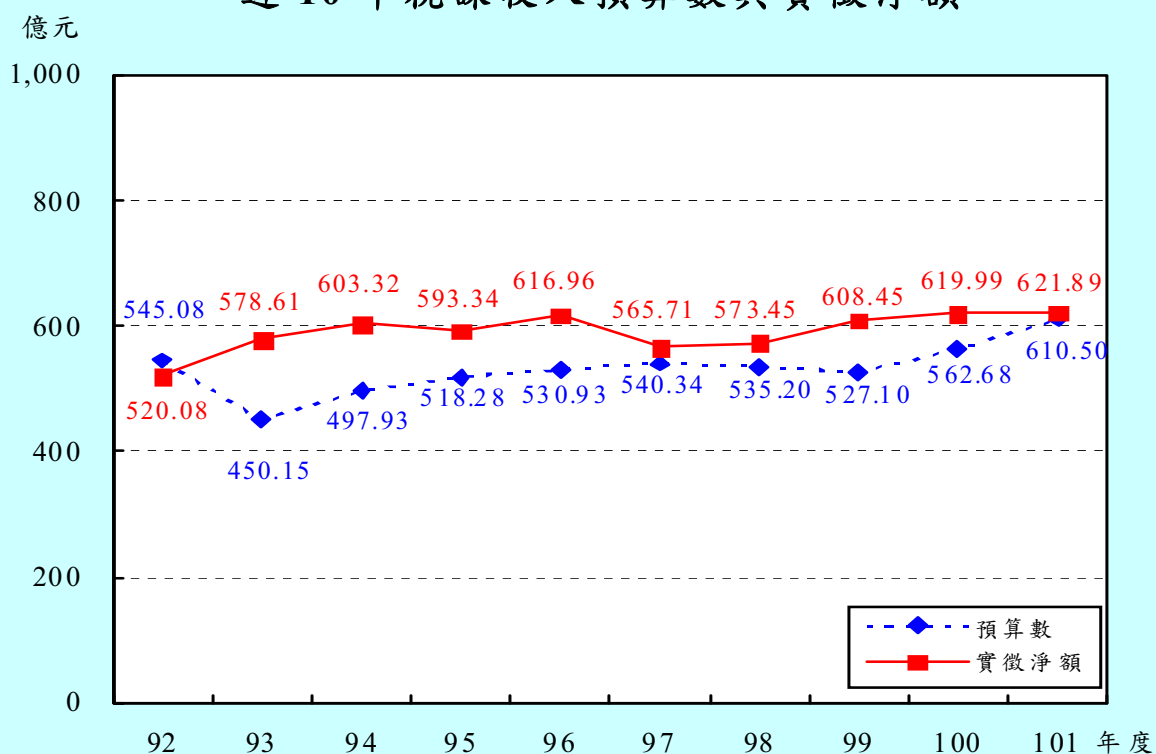

三、地價稅

101 年度實徵淨額 206.7 億元，與預算數 195 億元比較，增加 11.7 億元，超徵 6%；較上年度實徵淨額 205.05 億元增加 1.65 億元，成長 0.8%。

因清查成績顯著、加強欠稅清理及原適用優惠稅率之臨時路外停車場期限屆滿後，按一般用地稅率課徵地價稅，致稅收超徵且較上年度增加。

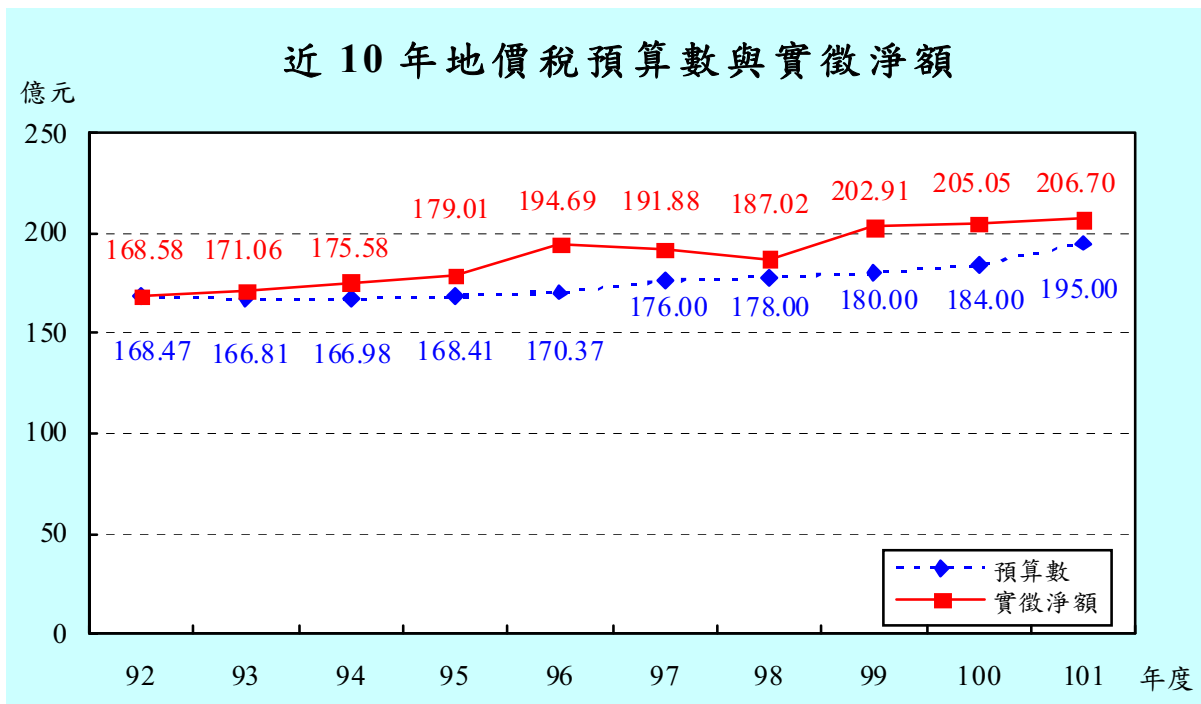

101 年度地價稅稅源比重(土地別)

面積總計 5,034.7634 公頃

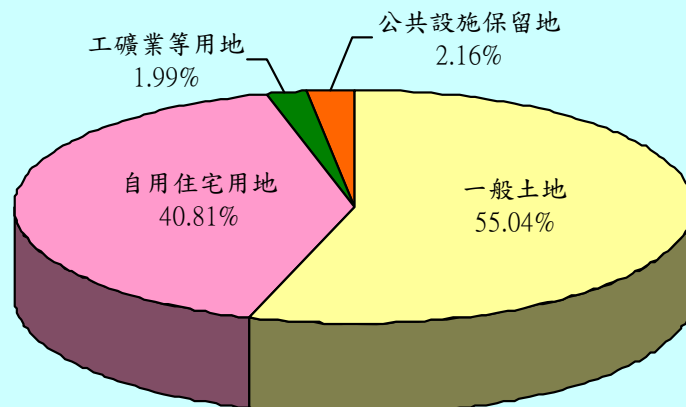

四、土地增值稅

101 年度實徵淨額 163.97 億元，與預算數 170 億元比較，減少 6.03 億元，短徵 3.5%；較上年度實徵淨額 174.07 億元減少 10.1 億元，負成長 5.8%。

101 年不動產交易量受特種貨物及勞務稅與 101 年 8 月 1 日實施實價登錄制度影響而銳減，致稅收短徵並較上年度減少。

近 10 年土地增值稅預算數與實徵淨額

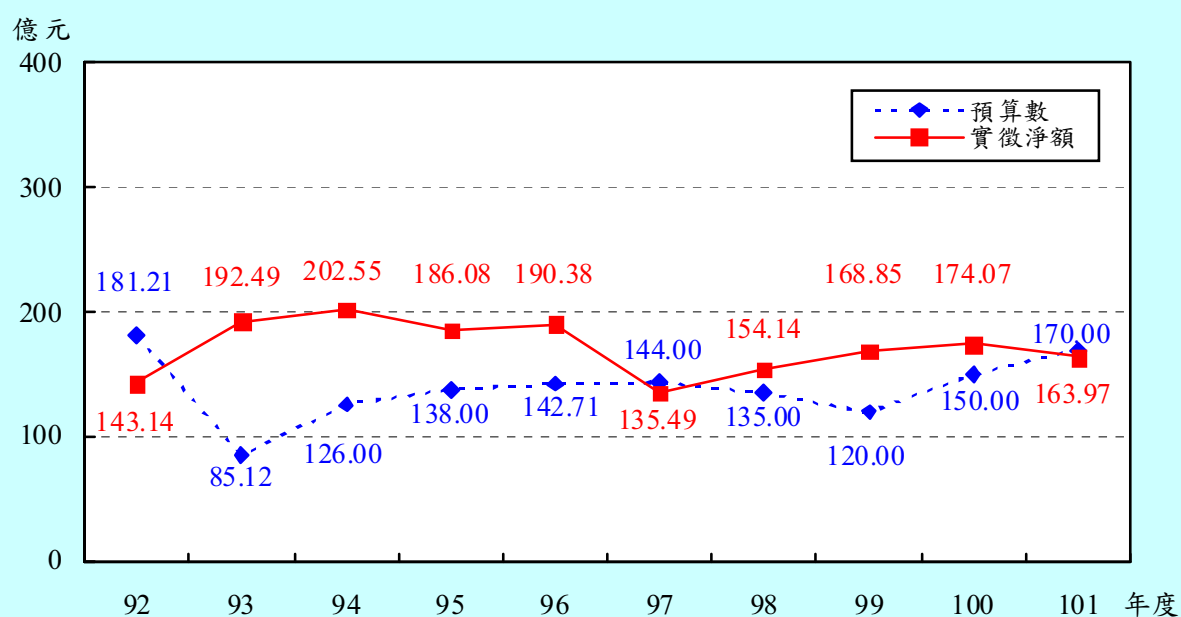

近 10 年移轉土地增值情形

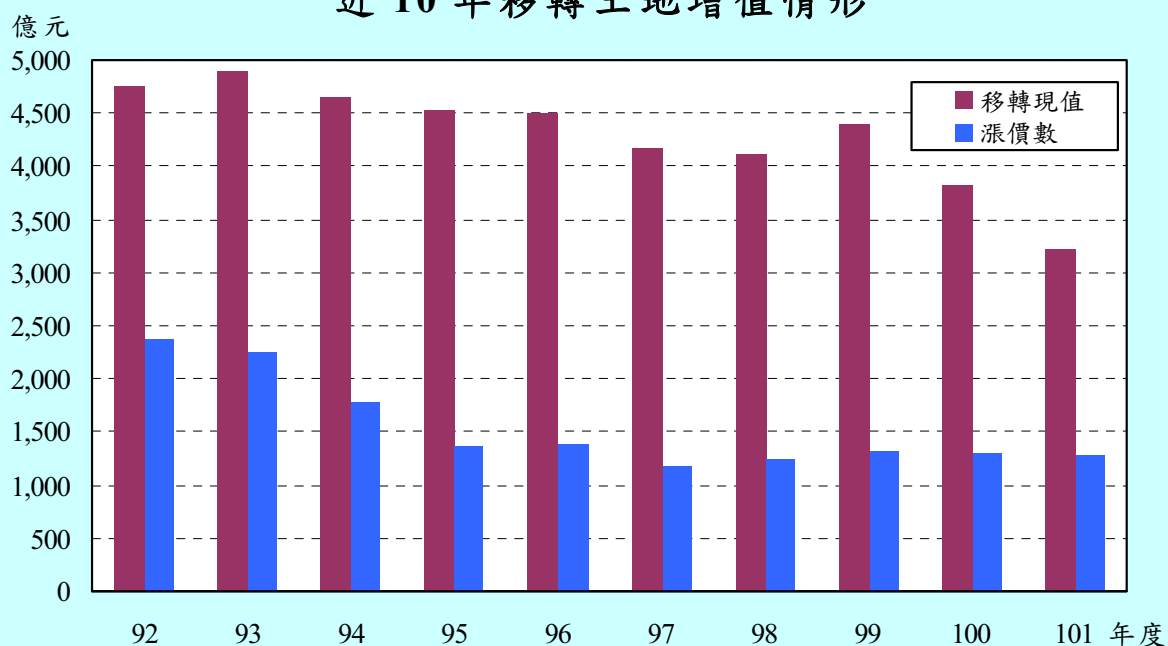

五、房屋稅

101 年度實徵淨額 118.6 億元，與預算數 114 億元比較，增加 4.6 億元，超徵 4%；較上年度實徵淨額 108.65 億元增加 9.95 億元，成長 9.2%。

101 年實施高級住宅加價課徵房屋稅、調整房屋路段率、新建房屋增加、加強房屋稅稅籍清查、積極清理欠稅及提高繳款書送達率，致稅收超徵且較上年度增加。

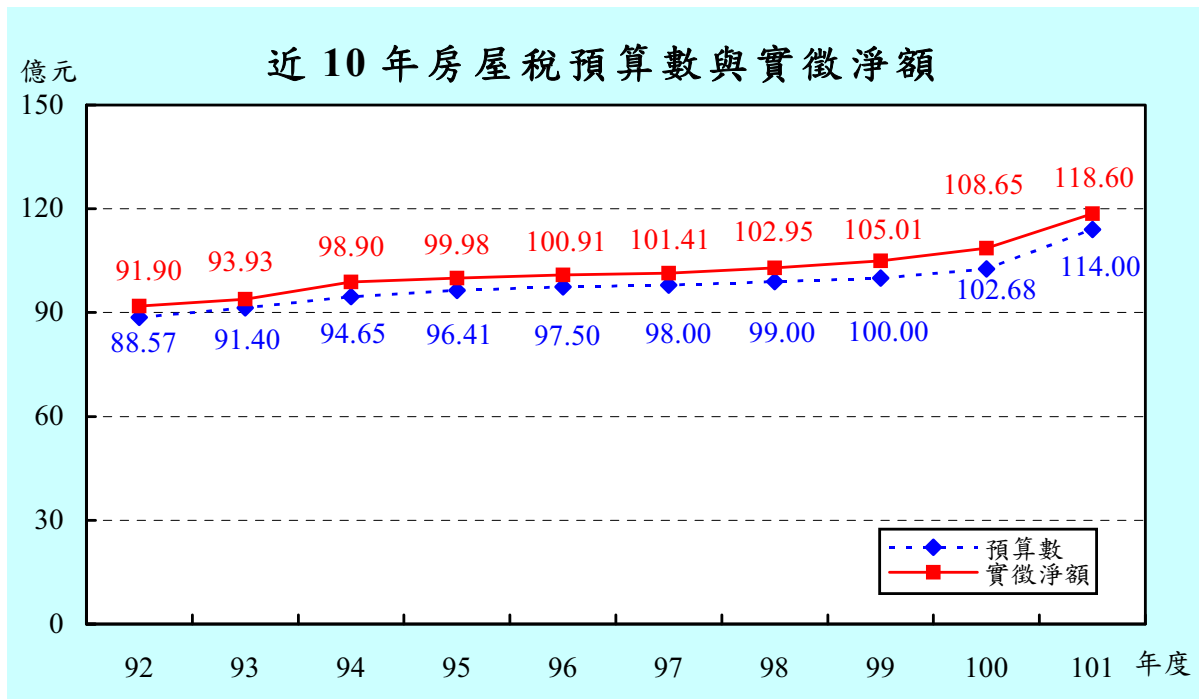

101 年度房屋稅稅源比重(構造別面積)

總計 180,692,750 平方公尺

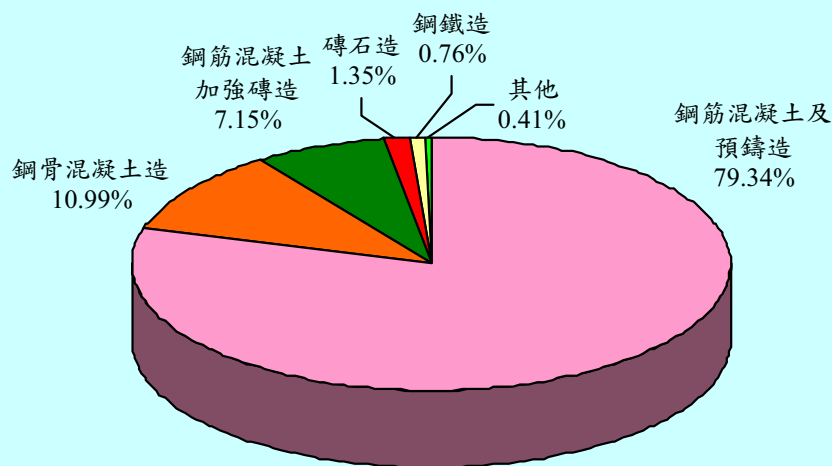

六、使用牌照稅

101 年度實徵淨額 68.28 億元，與預算數 64.5 億元比較，增加 3.78 億元，超徵 5.9%；較上年度實徵淨額 67.27 億元增加 1.01 億元，成長 1.5%。

因積極辦理免稅案件清查、欠稅清理及汽車車輛數成長，致稅收超徵且較上年度增加。

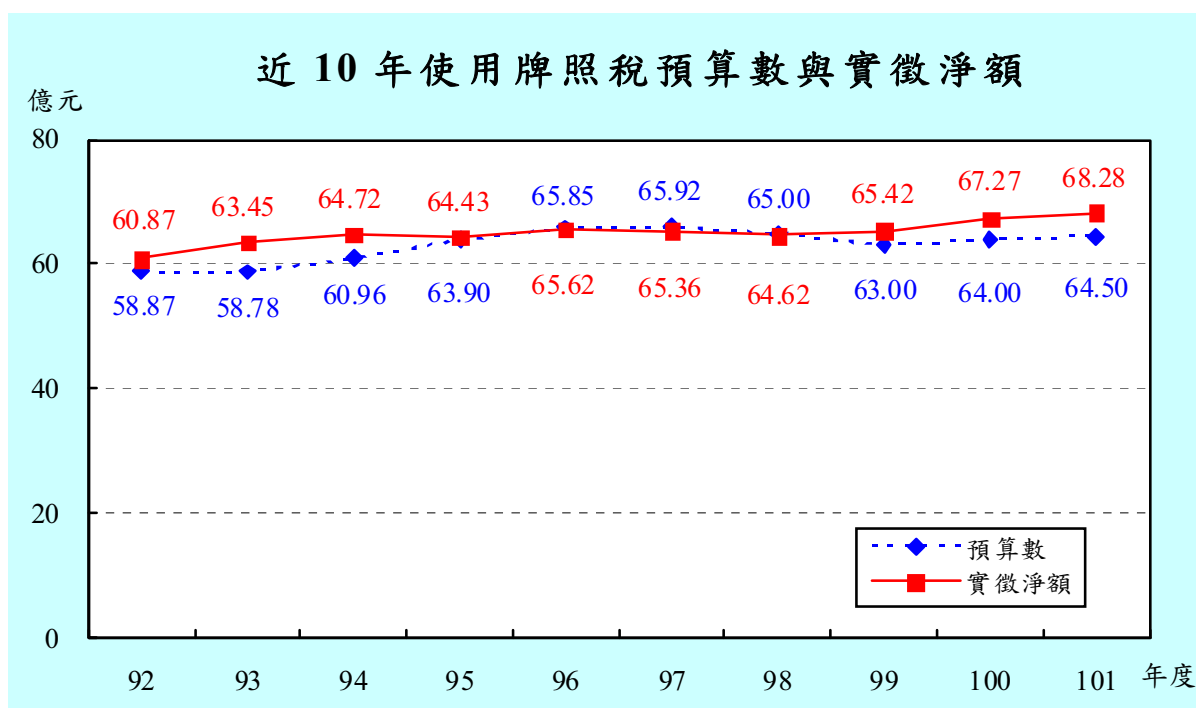

101 年度使用牌照稅稅源比重(車輛別)

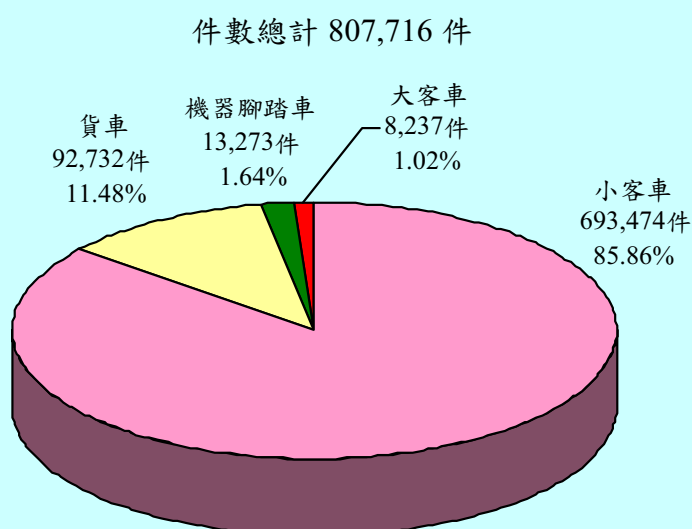

七、契稅

101 年度實徵淨額 17.31 億元，與預算數 24 億元比較，減少 6.69 億元，短徵 27.9%；較上年度實徵淨額 20.04 億元減少 2.73 億元，負成長 13.6%。

101 年不動產交易量受特種貨物及勞務稅與 101 年 8 月 1 日實施實價登錄制度影響而銳減，致稅收短徵並較上年度減少。

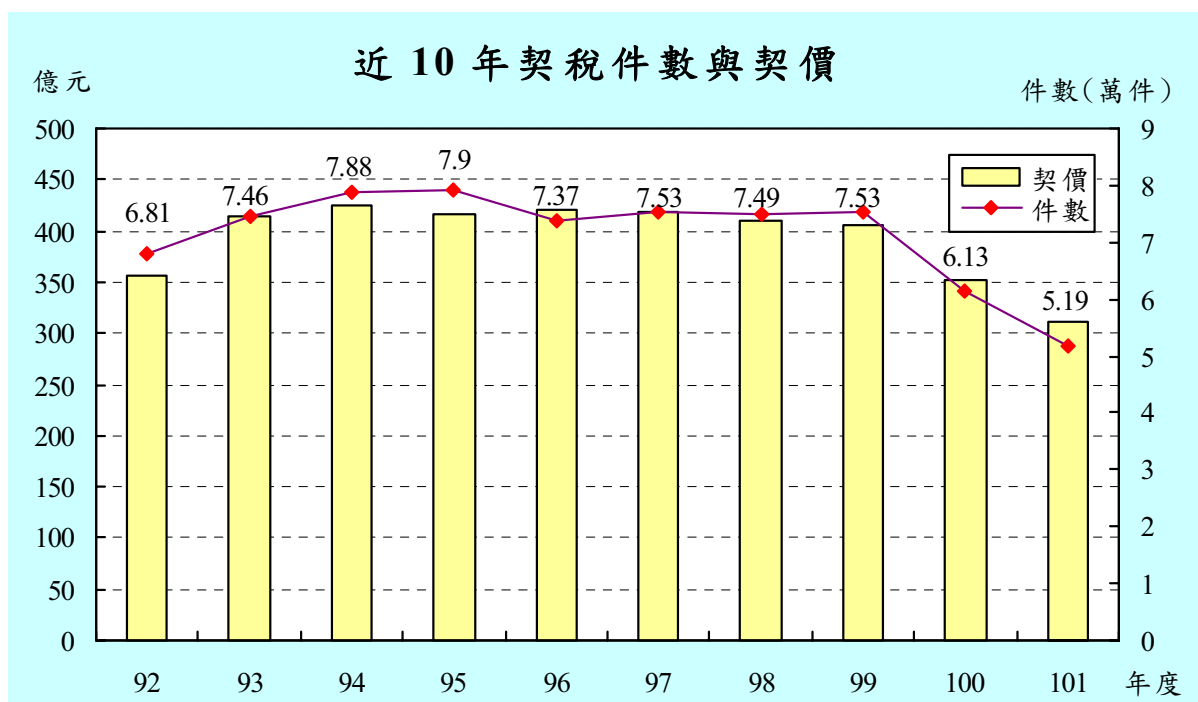
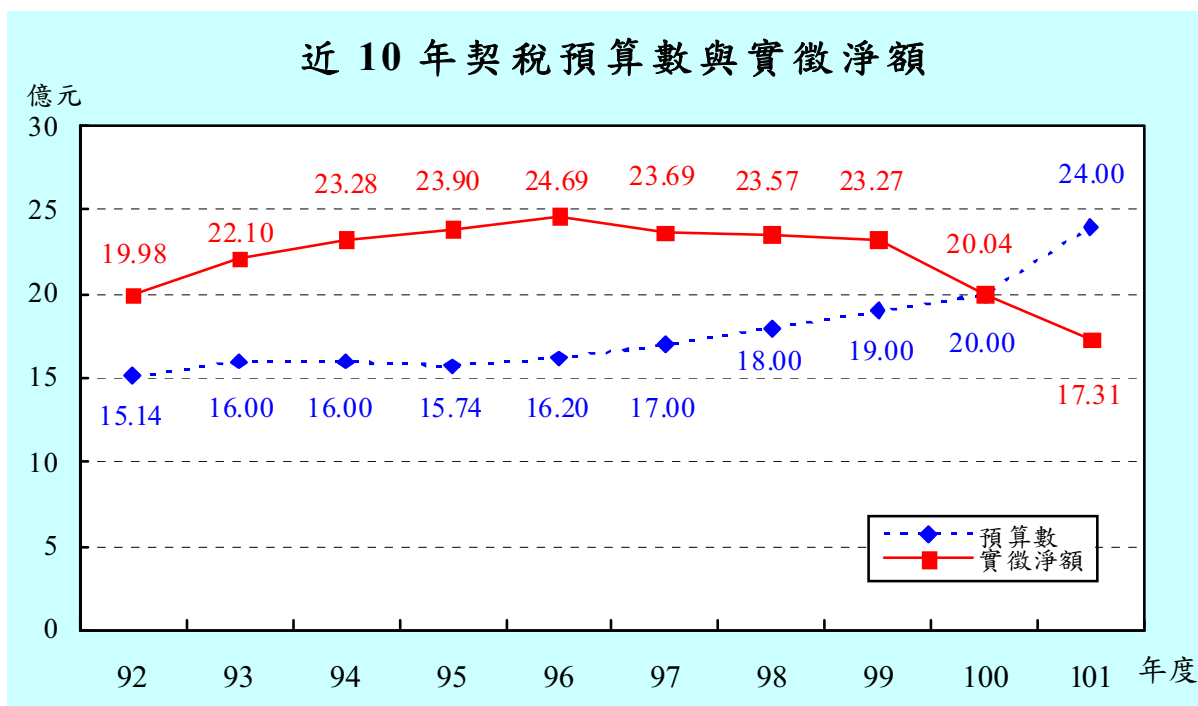

八、印花稅

101 年度實徵淨額 44.79 億元，與預算數 41 億元比較，增加 3.79 億元，超徵 9.2%；較上年度實徵淨額 42.47 億元增加 2.32 億元，成長 5.5%。

因執行印花稅應稅憑證檢查作業及積極輔導納稅義務人依法貼用印花稅票，致稅收超徵且較上年度增加。

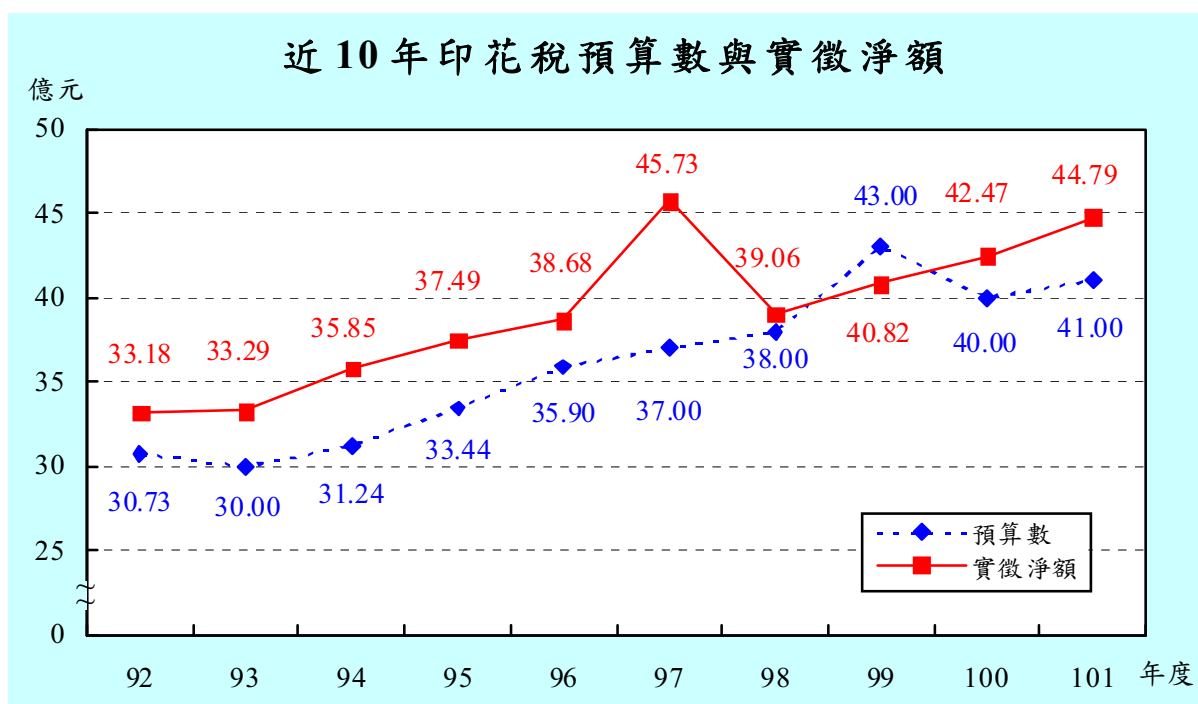

101 年度印花稅稅源比重(業別)

實徵數總計 44.66 億元

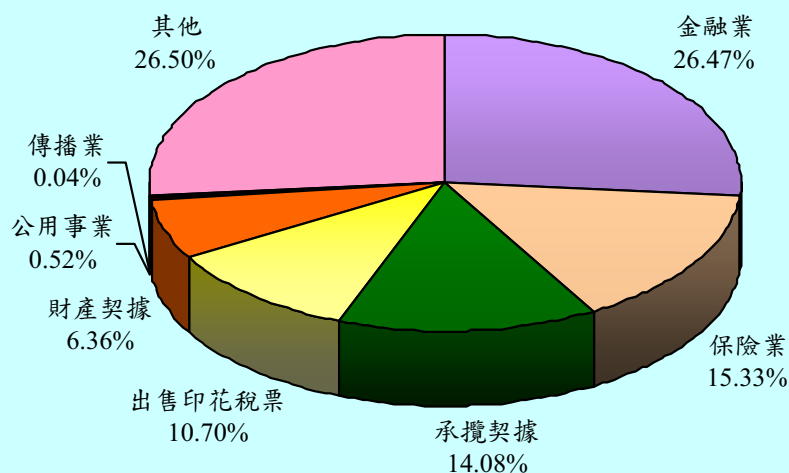

九、娛樂稅

101 年度實徵淨額 2.24 億元，與預算數 2 億元比較，增加 0.24 億元，超徵 12.1%；較上年度實徵淨額 2.44 億元減少 0.2 億元，負成長 8.1%。

101 年度因舉辦臨時性娛樂表演增多，致稅收較預算處超徵。惟臺北國際花卉博覽會營運至 100 年 4 月底止，101 年度少了博覽會挹注稅收，致稅收較 100 年度減少。

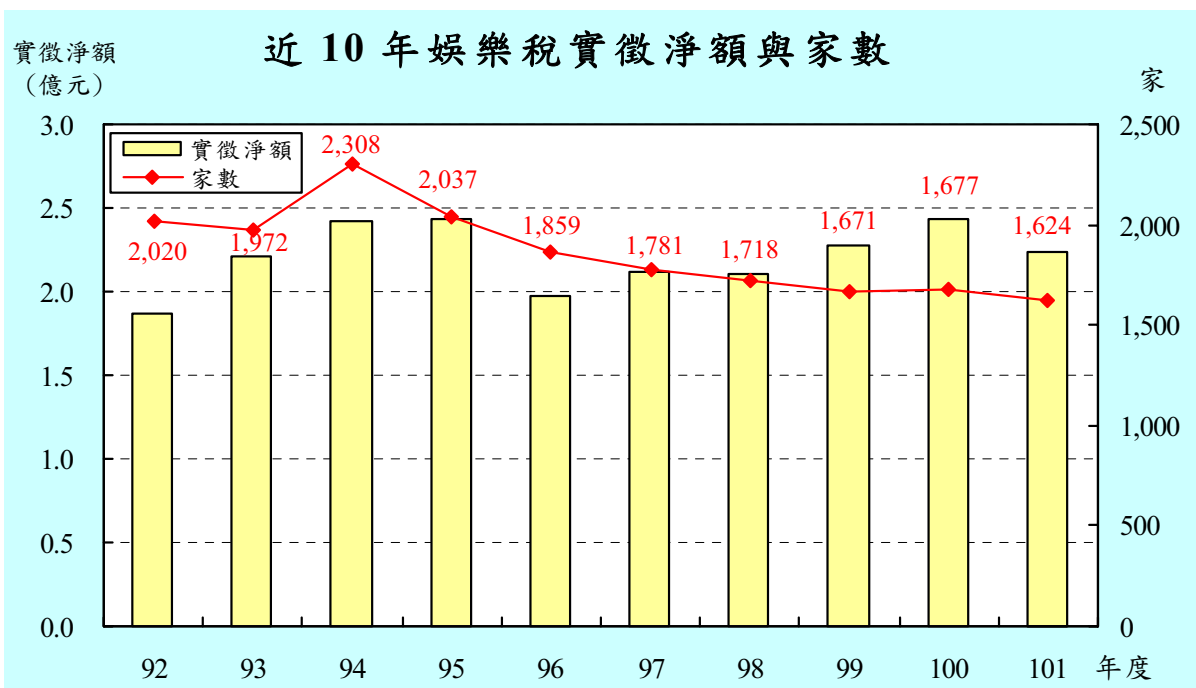
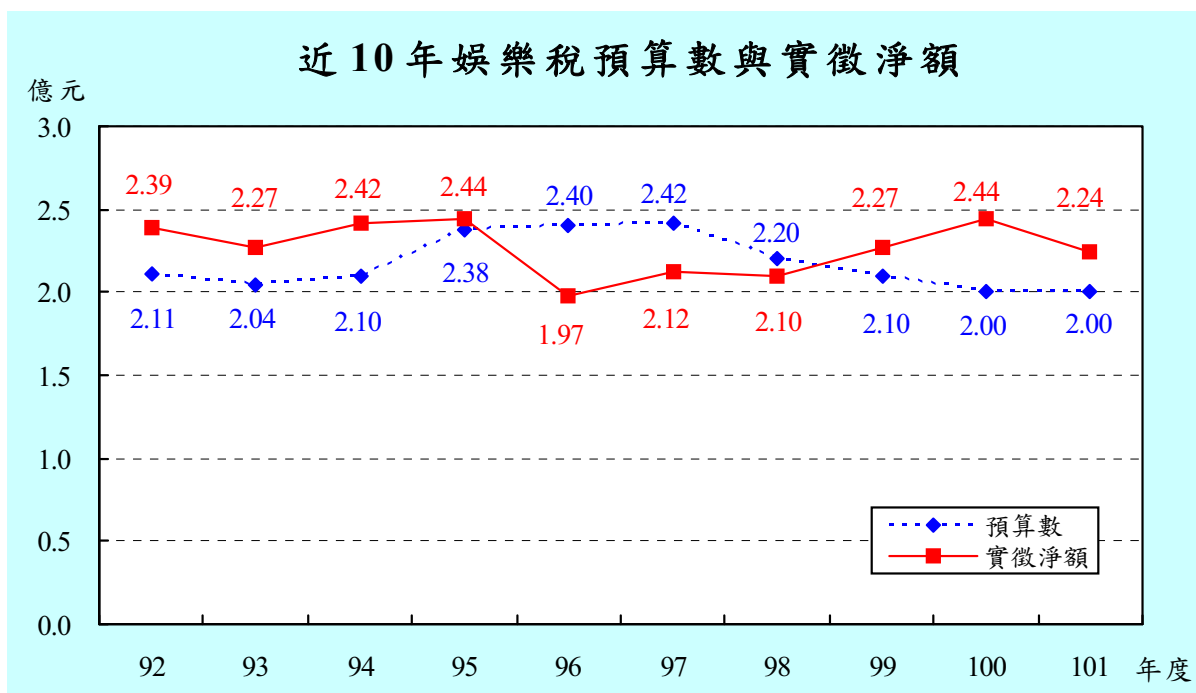

貳、稅收統計

II . Tax Revenue Statistics

表 1 各項稅捐徵績比較

單位：新臺幣千元

稅目別 Item of Tax	101 年 度		FY 2012			
	預算數 Budget Amount	查定數① Audited Amount	實徵數② Actual Collection	退還以前 年度歲入款 Tax Income Returned	實徵淨額 Net Actual Collection	實徵數 占預算數 % Actual Collection/ Budget Amount
總 計 Grand Total	61,185,000	65,905,662	62,751,394	444,488	62,306,906	102.6
稅 課 收 入 Revenues from Taxes	61,050,000	65,409,563	62,620,653	431,514	62,189,138	102.6
地 價 稅 Land Value Tax	19,500,000	21,916,616	20,748,022	77,498	20,670,524	106.4
土 地 增 值 稅 Land Value Increment Tax	17,000,000	17,566,789	16,674,778	277,564	16,397,214	98.1
房 屋 稅 House Tax	11,400,000	12,145,932	11,869,544	9,610	11,859,935	104.1
使 用 牌 照 稅 Vehicle License Tax	6,450,000	7,210,014	6,833,178	5,452	6,827,726	105.9
契 稅 Deed Tax	2,400,000	1,801,128	1,779,320	48,555	1,730,766	74.1
印 花 稅 Stamp Tax	4,100,000	4,528,290	4,490,891	12,319	4,478,571	109.5
娛 樂 稅 Amusement Tax	200,000	239,595	224,615	477	224,138	112.3
教 育 經 費 Education Surtax	—	1,201	304	40	264	--
工 程 受 益 費 Construction Benefit Fee	—	—	—	—	—	--
罰 鍰 收 入 Punitive Fine Revenue	135,000	496,099	130,741	12,973	117,768	96.8
規 費 收 入 Fees Revenue	—	—	—	—	—	--
契 稅 監 證 費 Fees	—	—	—	—	—	--

資料來源：依據徵課會計報告編製。

附 註：①查定數包括以前年度結轉數。

②99年度起實徵數未含實物抵繳稅款(以遞延收入入帳)。

Table 1. Net Tax Revenues Compare

Unit : N.T.\$1,000

實徵淨額 占預算數 % Net Actual Collection/ Budget Amount	101年度與100年度比較 Compare FY2012 with FY2011			100年度與99度比較 Compare FY2011 with FY2010		
	100年度 實徵淨額 Net Actual Collection FY 2011	增減數 Amount	增減 %	99年度 實徵淨額 Net Actual Collection FY2010	增減數 Amount	增減 %
101.8	62,159,442	147,464	0.2	60,905,235	1,254,207	2.1
101.9	61,999,268	189,871	0.3	60,844,915	1,154,353	1.9
106.0	20,505,209	165,315	0.8	20,291,042	214,167	1.1
96.5	17,407,266	-1,010,052	-5.8	16,884,890	522,376	3.1
104.0	10,865,123	994,811	9.2	10,500,537	364,586	3.5
105.9	6,726,767	100,960	1.5	6,542,070	184,697	2.8
72.1	2,004,331	- 273,565	-13.6	2,327,147	- 322,816	-13.9
109.2	4,246,762	231,810	5.5	4,082,316	164,445	4.0
112.1	243,807	- 19,670	-8.1	226,873	16,935	7.5
--	3	261	8,714.6	- 9,960	9,963	--
--	42	- 42	--	--	42	--
87.2	160,132	- 42,365	-26.5	60,320	99,812	165.5
--	--	--	--	--	--	--
--	--	--	--	--	--	--

表 2 歷年各項稅捐預算數、查定數與實徵數

(一)總計①

單位：新臺幣元

年度(月)別 Fiscal Year (Month)	預算數 Budget Amount (A)	查定數 Audited Amount		
		合計 Total	本年度 Current FY	以前年度② Previous FY
92 年度 FY 2003	54,618,192,000	61,012,289,193	54,206,870,360	6,805,418,833
93 年度 FY 2004	45,137,660,860	65,846,223,776	58,770,576,018	7,075,647,758
94 年度 FY 2005	49,981,343,000	68,597,652,306	61,005,462,738	7,592,189,568
95 年度 FY 2006	52,011,000,000	66,672,822,287	59,184,231,898	7,488,590,389
96 年度 FY 2007	53,276,009,000	68,462,333,538	62,102,868,839	6,359,464,699
97 年度 FY 2008	54,238,000,000	63,451,419,838	57,508,965,836	5,942,454,002
98 年度 FY 2009	53,721,000,000	62,756,930,153	57,011,890,023	5,745,040,130
99 年度 FY 2010	52,865,000,000	65,873,934,825	61,521,291,170	4,352,643,655
100 年度 FY 2011	56,422,260,000	65,754,247,039	61,847,950,043	3,906,296,996
101 年度 FY 2012	61,185,000,000	65,905,662,486	62,733,494,186	3,172,168,300
1 月 Jan.	2,227,229,000	5,648,353,648	2,313,094,983	3,335,258,665
2 月 Feb.	1,934,253,000	1,395,432,206	1,440,123,775	- 44,691,569
3 月 Mar.	3,043,954,000	2,160,946,342	2,171,960,892	- 11,014,550
4 月 Apr.	5,307,745,000	7,374,021,664	7,387,367,876	- 13,346,212
5 月 May	10,798,233,000	14,109,441,633	14,110,776,607	- 1,334,974
6 月 June	5,871,066,000	1,772,772,569	1,803,607,750	- 30,835,181
7 月 July	2,314,384,000	2,623,227,496	2,630,990,721	-7,763,225
8 月 Aug.	1,998,131,000	1,486,383,345	1,498,718,672	- 12,335,327
9 月 Sep.	2,516,938,000	1,924,947,304	1,939,511,640	-14,564,336
10 月 Oct.	2,001,984,000	2,082,920,814	2,092,525,854	- 9,605,040
11 月 Nov.	11,822,349,000	23,149,760,497	23,161,456,454	- 11,695,957
12 月 Dec.	11,348,734,000	2,177,454,968	2,183,358,962	-5,903,994

附註：①總計=稅課收入+工程受益費+罰鍰收入+規費收入(監證費)。

②包括以前年度結轉數。

③99年度起實徵數未含實物抵繳稅款(以遞延收入入帳)。

Table 2. Budget Amount, Audited Amount and Actual Collection
in Recent Years

(I) Grand Total ①

Unit : N.T.\$1

實 徵 數 Actual Collection ③			退還以前年度 歲入款 Tax Income Returned (4)	實 徵 淨 額 Net Actual Collection (1-4=5)	實徵淨額 占預算數 % Net Actual Collection /Budge Amount (5/A)×100
合 計 Total (2+3=1)	本 年 度 Current FY (2)	以 前 年 度 Previous FY (3)			
52,727,536,378	50,486,009,550	2,241,526,828	712,328,399	52,015,207,979	95.2
58,546,075,931	55,922,819,548	2,623,256,383	501,948,741	58,044,127,190	128.6
60,821,499,933	58,345,872,794	2,475,627,139	278,499,442	60,543,000,491	121.1
59,935,082,828	57,140,304,656	2,794,778,172	375,940,451	59,559,142,377	114.5
62,211,212,658	60,107,595,743	2,103,616,915	330,261,624	61,880,951,034	116.2
57,349,343,608	55,240,378,164	2,108,965,444	595,865,819	56,753,477,789	104.6
57,906,303,509	55,585,418,083	2,320,885,426	408,280,057	57,498,023,452	107.0
61,412,898,686	59,915,978,897	1,496,919,789	507,663,766	60,905,234,920	115.2
62,364,742,945	60,525,743,015	1,838,999,930	205,300,912	62,159,442,033	110.2
62,751,393,789	61,392,970,041	1,358,423,748	444,487,791	62,306,905,998	101.8
2,236,996,247	1,837,680,766	399,315,481	175,159,278	2,061,836,969	92.6
1,577,194,952	1,477,246,847	99,948,105	27,691,060	1,549,503,892	80.1
2,312,602,213	2,215,952,639	96,649,574	14,153,779	2,298,448,434	75.5
4,981,008,591	4,839,562,338	141,446,253	19,249,237	4,961,759,354	93.5
11,927,093,717	11,809,900,116	117,193,601	18,742,314	11,908,351,403	110.3
6,078,881,268	5,885,308,723	193,572,545	72,959,789	6,005,921,479	102.3
2,945,936,191	2,876,446,547	69,489,644	32,062,140	2,913,874,051	125.9
1,595,888,157	1,551,126,238	44,761,919	36,398,276	1,559,489,881	78.0
1,961,741,915	1,919,227,662	42,514,253	10,627,561	1,951,114,354	77.5
1,844,089,088	1,769,834,983	74,254,105	15,055,204	1,829,033,884	91.4
13,633,356,427	13,586,212,114	47,144,313	10,385,028	13,622,971,399	115.2
11,656,605,023	11,624,471,068	32,133,955	12,004,125	11,644,600,898	102.6

表 2 歷年各項稅捐預算數、查定數與實徵數 (續1)

(二)稅課收入

1. 合計

單位：新臺幣元

年度(月)別 Fiscal Year (Month)	預算數 Budget Amount (A)	查定數 Audited Amount		
		合計 Total	本年度 Current FY	以前年度 ^① Previous FY
92 年度 FY 2003	54,508,305,000	60,494,939,614	54,095,630,293	6,399,309,321
93 年度 FY 2004	45,014,639,860	65,352,534,743	58,653,423,252	6,699,111,491
94 年度 FY 2005	49,793,343,000	68,132,972,862	60,886,814,259	7,246,158,603
95 年度 FY 2006	51,828,000,000	66,235,324,703	59,111,525,544	7,123,799,159
96 年度 FY 2007	53,093,009,000	68,020,104,766	61,976,402,641	6,043,702,125
97 年度 FY 2008	54,034,000,000	62,976,080,816	57,346,759,662	5,629,321,154
98 年度 FY 2009	53,520,000,000	62,262,066,305	56,854,450,564	5,407,615,741
99 年度 FY 2010	52,710,000,000	65,326,212,670	61,317,097,584	4,009,115,086
100 年度 FY 2011	56,268,260,000	65,190,790,529	61,714,468,538	3,476,321,991
101 年度 FY 2012	61,050,000,000	65,409,563,052	62,634,837,985	2,774,725,067
1 月 Jan.	2,221,764,000	5,257,318,464	2,304,273,374	2,953,045,090
2 月 Feb.	1,923,293,000	1,388,861,526	1,437,435,947	- 48,574,421
3 月 Mar.	3,030,949,000	2,154,357,531	2,169,224,907	- 14,867,376
4 月 Apr.	5,297,685,000	7,368,262,613	7,383,297,035	- 15,034,422
5 月 May	10,780,393,000	14,092,128,492	14,095,401,932	- 3,273,440
6 月 June	5,858,896,000	1,767,204,841	1,796,284,003	- 29,079,162
7 月 July	2,306,269,000	2,613,242,195	2,624,461,604	-11,219,409
8 月 Aug.	1,986,116,000	1,480,440,798	1,494,203,076	- 13,762,278
9 月 Sep.	2,501,143,000	1,916,357,403	1,932,810,000	-16,452,597
10 月 Oct.	1,995,034,000	2,076,923,835	2,084,872,318	- 7,948,483
11 月 Nov.	11,812,454,000	23,138,521,618	23,149,968,901	- 11,447,283
12 月 Dec.	11,336,004,000	2,155,943,736	2,162,604,888	-6,661,152

附註：①包括以前年度結轉數。

②99年度起實徵數未含實物抵繳稅款(以遞延收入入帳)。

Table 2. Budget Amount, Audited Amount and Actual Collection
in Recent Years (Cont. 1)

(II) Revenues from Taxes

1. Total

Unit : N.T.\$1

實 徵 數 Actual Collection ②		退還以前年度 歲入款 Tax Income Returned (4)	實 徵 淨 額 Net Actual Collection (1-4=5)	實徵淨額 占預算數 % Net Actual Collection /Budge Amount (5/A)×100	
合 計 Total (2+3=1)	本 年 度 Current FY (2)				以 前 年 度 Previous FY (3)
52,517,285,079	50,428,922,057	2,088,363,022	509,523,958	52,007,761,121	95.4
58,315,056,227	55,829,055,068	2,486,001,159	454,178,455	57,860,877,772	128.5
60,597,567,284	58,278,178,350	2,319,388,934	265,326,790	60,332,240,494	121.2
59,704,949,774	57,086,468,516	2,618,481,258	371,162,603	59,333,787,171	114.5
62,019,116,746	60,048,819,696	1,970,297,050	323,317,992	61,695,798,754	116.2
57,157,456,189	55,176,188,981	1,981,267,208	586,921,874	56,570,534,315	104.7
57,706,501,696	55,526,927,616	2,179,574,080	361,017,806	57,345,483,890	107.1
61,246,934,737	59,853,800,575	1,393,134,162	402,019,755	60,844,914,982	115.4
62,176,573,002	60,466,079,308	1,710,493,694	177,305,299	61,999,267,703	110.2
62,620,652,883	61,349,810,533	1,270,842,350	431,514,478	62,189,138,405	101.9
2,222,885,385	1,836,512,107	386,373,278	174,436,490	2,048,448,895	92.2
1,566,105,137	1,475,965,325	90,139,812	27,054,017	1,539,051,120	80.0
2,302,077,436	2,215,006,300	87,071,136	13,723,738	2,288,353,698	75.5
4,971,113,305	4,838,679,814	132,433,491	19,076,114	4,952,037,191	93.5
11,914,188,891	11,803,384,238	110,804,653	17,590,773	11,896,598,118	110.4
6,069,981,597	5,881,591,387	188,390,210	71,580,994	5,998,400,603	102.4
2,934,741,837	2,872,422,535	62,319,302	30,983,246	2,903,758,591	125.9
1,587,222,134	1,547,469,541	39,752,593	34,018,177	1,553,203,957	78.2
1,951,826,875	1,915,364,987	36,461,888	10,184,210	1,941,642,665	77.6
1,836,934,391	1,766,194,281	70,740,110	14,727,605	1,822,206,786	91.3
13,623,814,711	13,581,006,665	42,808,046	9,711,832	13,614,102,879	115.3
11,639,761,184	11,616,213,353	23,547,831	8,427,282	11,631,333,902	102.6

表 2 歷年各項稅捐預算數、查定數與實徵數 (續2)

(二)稅課收入

2. 地價稅

單位：新臺幣元

年度(月)別 Fiscal Year (Month)	預算數 Budget Amount (A)	查定數 Audited Amount		
		合計 Total	本年度 Current FY	以前年度 Previous FY
92 年度 FY 2003	16,846,586,000	20,825,423,233	17,716,621,897	3,108,801,336
93 年度 FY 2004	16,681,444,000	20,566,603,064	17,488,292,574	3,078,310,490
94 年度 FY 2005	16,697,695,000	21,023,343,012	17,744,063,944	3,279,279,068
95 年度 FY 2006	16,841,000,000	20,877,369,503	17,631,744,847	3,245,624,656
96 年度 FY 2007	17,037,000,000	22,406,238,656	19,665,335,019	2,740,903,637
97 年度 FY 2008	17,600,000,000	21,622,348,590	18,962,431,757	2,659,916,833
98 年度 FY 2009	17,800,000,000	20,775,773,127	18,637,378,171	2,138,394,956
99 年度 FY 2010	18,000,000,000	22,108,091,007	20,315,591,574	1,792,499,433
100 年度 FY 2011	18,400,000,000	21,729,735,988	20,213,024,931	1,516,711,057
101 年度 FY 2012	19,500,000,000	21,916,615,715	20,793,949,827	1,122,665,888
1 月 Jan.	147,265,000	1,215,192,072	34,175,318	1,181,016,754
2 月 Feb.	119,550,000	13,283,057	24,225,867	- 10,942,810
3 月 Mar.	86,559,000	57,085,187	61,555,945	- 4,470,758
4 月 Apr.	135,381,000	99,190,924	104,125,819	- 4,934,895
5 月 May	130,753,000	48,875,363	52,923,827	- 4,048,464
6 月 June	55,188,000	44,205,545	55,944,128	- 11,738,583
7 月 July	36,843,000	40,170,516	45,788,942	- 5,618,426
8 月 Aug.	62,551,000	78,185,582	81,357,941	- 3,172,359
9 月 Sep.	58,344,000	32,807,516	34,929,772	-2,122,256
10 月 Oct.	198,772,000	219,017,389	221,826,022	- 2,808,633
11 月 Nov.	9,464,455,000	20,024,952,774	20,028,055,244	- 3,102,470
12 月 Dec.	9,004,339,000	43,649,790	49,041,002	-5,391,212

Table 2. Budget Amount, Audited Amount and Actual Collection
in Recent Years (Cont. 2)

(II) Revenues from Taxes

2. Land Value Tax

Unit : N.T.\$1

實徵數 Actual Collection			退還以前年度 歲入款 Tax Income Returned (4)	實徵淨額 Net Actual Collection (1-4=5)	實徵淨額 占預算數 % Net Actual Collection /Budge Amount (5/A)×100
合計 Total (2+3=1)	本年度 Current FY (2)	以前年度 Previous FY (3)			
16,943,579,883	15,874,921,311	1,068,658,572	85,189,421	16,858,390,462	100.1
17,245,631,135	16,237,683,296	1,007,947,839	139,724,220	17,105,906,915	102.5
17,642,901,242	16,674,917,773	967,983,469	85,128,173	17,557,773,069	105.2
17,966,408,173	16,742,406,708	1,224,001,465	65,594,730	17,900,813,443	106.3
19,562,228,351	18,649,206,309	913,022,042	93,531,178	19,468,697,173	114.3
19,336,852,287	18,205,651,270	1,131,201,017	148,458,460	19,188,393,827	109.0
18,836,109,030	18,029,123,615	806,985,415	133,715,429	18,702,393,601	105.1
20,332,765,697	19,623,815,795	708,949,902	41,724,158	20,291,041,539	112.7
20,534,137,009	19,743,790,367	790,346,642	28,928,504	20,505,208,505	111.4
20,748,021,644	20,243,111,064	504,910,580	77,497,739	20,670,523,905	106.0
120,547,831	19,066,926	101,480,905	4,894,974	115,652,857	78.5
78,427,880	32,365,685	46,062,195	1,792,197	76,635,683	64.1
73,463,105	19,904,894	53,558,211	2,723,334	70,739,771	81.7
170,254,315	78,271,832	91,982,483	1,795,262	168,459,053	124.4
133,815,683	50,646,997	83,168,686	2,696,677	131,119,006	100.3
61,610,635	42,675,751	18,934,884	12,154,559	49,456,076	89.6
76,818,491	49,565,437	27,253,054	11,659,012	65,159,479	176.9
67,904,132	39,130,679	28,773,453	26,070,972	41,833,160	66.9
47,757,205	28,398,573	19,358,632	4,408,736	43,348,469	74.3
252,854,104	242,061,560	10,792,544	289,809	252,564,295	127.1
10,375,843,566	10,362,044,722	13,798,844	2,665,833	10,373,177,733	109.6
9,288,724,697	9,278,978,008	9,746,689	6,346,374	9,282,378,323	103.1

表 2 歷年各項稅捐預算數、查定數與實徵數 (續3)

(二)稅課收入

3. 土地增值稅

單位：新臺幣元

年度(月)別 Fiscal Year (Month)	預算數 Budget Amount (A)	查定數 Audited Amount		
		合計 Total	本年度 Current FY	以前年度 Previous FY
92年度 FY 2003	18,120,516,000	16,375,298,195	15,395,785,720	979,512,475
93年度 FY 2004	8,511,878,000	20,700,072,384	19,299,421,992	1,400,650,392
94年度 FY 2005	12,600,000,000	22,419,548,012	20,699,450,225	1,720,097,787
95年度 FY 2006	13,800,000,000	20,479,966,834	18,573,005,660	1,906,961,174
96年度 FY 2007	14,271,009,000	20,581,406,339	19,082,471,654	1,498,934,685
97年度 FY 2008	14,400,000,000	15,838,196,306	14,501,930,736	1,336,265,570
98年度 FY 2009	13,500,000,000	16,754,143,332	14,953,917,653	1,800,225,679
99年度 FY 2010	12,000,000,000	18,231,273,864	17,212,755,478	1,018,518,386
100年度 FY 2011	15,000,000,000	18,530,330,855	17,550,051,311	980,279,544
101年度 FY 2012	17,000,000,000	17,566,789,041	16,633,841,191	932,947,850
1月 Jan.	1,190,000,000	2,243,583,654	1,277,781,290	965,802,364
2月 Feb.	1,405,836,000	1,075,832,880	1,105,014,391	- 29,181,511
3月 Mar.	1,752,862,000	1,062,656,386	1,069,452,697	- 6,796,311
4月 Apr.	1,212,554,000	1,175,686,860	1,176,608,370	- 921,510
5月 May	1,234,220,000	1,490,305,928	1,490,917,906	- 611,978
6月 June	1,442,688,000	1,522,022,602	1,522,794,236	- 771,634
7月 July	1,317,825,000	1,667,539,853	1,667,621,164	-81,311
8月 Aug.	1,390,763,000	1,079,422,739	1,079,930,026	- 507,287
9月 Sep.	1,567,453,000	1,028,527,632	1,028,527,632	—
10月 Oct.	1,335,091,000	1,214,439,538	1,214,504,058	- 64,520
11月 Nov.	1,308,799,000	2,232,318,163	2,232,352,314	- 34,151
12月 Dec.	1,841,909,000	1,774,452,806	1,768,337,107	6,115,699

附註：1、91年2月1日至94年1月31日止土地增值稅減半徵收3年。

2、自94年2月1日起一般用地稅率調降為20%、30%、40%。

Table 2. Budget Amount, Audited Amount and Actual Collection
in Recent Years (Cont. 3)

(II) Revenues from Taxes

3. Land Value Increment Tax

Unit : N.T.\$1

實徵數 Actual Collection			退還以前年度 歲入款 Tax Income Returned (4)	實徵淨額 Net Actual Collection (1-4=5)	實徵淨額 占預算數 % Net Actual Collection /Budge Amount (5/A)×100
合計 Total (2+3=1)	本年度 Current FY (2)	以前年度 Previous FY (3)			
14,720,934,047	14,178,967,770	541,966,277	406,791,319	14,314,142,728	79.0
19,527,565,086	18,559,316,795	968,248,291	278,117,108	19,249,447,978	226.1
20,417,762,328	19,665,600,010	752,162,318	162,801,073	20,254,961,255	160.8
18,880,808,661	17,906,518,152	974,290,509	272,719,849	18,608,088,812	134.8
19,209,882,958	18,552,463,723	657,419,235	172,100,151	19,037,782,807	133.4
13,943,736,263	13,477,042,093	466,694,170	394,326,670	13,549,409,593	94.1
15,609,940,194	14,555,621,276	1,054,318,918	196,024,352	15,413,915,842	114.2
17,088,982,865	16,718,462,793	370,520,072	204,092,581	16,884,890,284	140.7
17,528,534,334	16,992,903,207	535,631,127	121,268,101	17,407,266,233	116.0
16,674,777,843	16,137,848,941	536,928,902	277,563,791	16,397,214,052	96.5
1,116,683,315	892,986,153	223,697,162	166,830,970	949,852,345	79.8
1,140,225,206	1,120,718,435	19,506,771	22,503,167	1,117,722,039	79.5
1,173,277,812	1,158,230,835	15,046,977	9,638,363	1,163,639,449	66.4
1,216,903,408	1,196,485,352	20,418,056	16,105,801	1,200,797,607	99.0
1,480,650,250	1,471,542,755	9,107,495	10,434,856	1,470,215,394	119.1
1,507,756,272	1,352,603,615	155,152,657	17,210,144	1,490,546,128	103.3
1,813,468,259	1,795,887,506	17,580,753	11,798,910	1,801,669,349	136.7
1,086,794,558	1,085,456,852	1,337,706	6,999,780	1,079,794,778	77.6
997,517,440	994,907,954	2,609,486	5,520,598	991,996,842	63.3
1,083,196,563	1,038,346,760	44,849,803	2,534,728	1,080,661,835	80.9
2,088,090,149	2,066,028,644	22,061,505	6,504,351	2,081,585,798	159.0
1,970,214,611	1,964,654,080	5,560,531	1,482,123	1,968,732,488	106.9

表 2 歷年各項稅捐預算數、查定數與實徵數 (續4)

(二)稅課收入

4. 房屋稅

單位：新臺幣元

年度(月)別 Fiscal Year (Month)	預算數 Budget Amount (A)	查定數 Audited Amount		
		合計 Total	本年度 Current FY	以前年度 Previous FY
92 年度 FY 2003	8,856,883,000	10,371,472,207	9,293,763,922	1,077,708,285
93 年度 FY 2004	9,139,824,000	10,695,487,923	9,545,780,030	1,149,707,893
94 年度 FY 2005	9,465,383,000	10,990,080,178	9,728,720,000	1,261,360,178
95 年度 FY 2006	9,641,000,000	11,066,349,485	9,998,789,101	1,067,560,384
96 年度 FY 2007	9,750,000,000	11,110,055,367	10,093,474,972	1,016,580,395
97 年度 FY 2008	9,800,000,000	11,078,405,809	10,126,254,227	952,151,582
98 年度 FY 2009	9,900,000,000	11,165,748,863	10,287,985,782	877,763,081
99 年度 FY 2010	10,000,000,000	11,216,744,220	10,584,535,806	632,208,414
100 年度 FY 2011	10,268,260,000	11,195,589,644	10,724,497,031	471,092,613
101 年度 FY 2012	11,400,000,000	12,145,931,799	11,853,364,805	292,566,994
1 月 Jan.	26,971,000	336,557,674	21,609,078	314,948,596
2 月 Feb.	39,479,000	9,524,609	12,621,094	- 3,096,485
3 月 Mar.	53,547,000	16,965,964	16,741,346	224,618
4 月 Apr.	293,827,000	113,964,880	118,654,572	- 4,689,692
5 月 May	6,639,658,000	11,607,215,236	11,604,158,712	3,056,524
6 月 June	3,929,442,000	-4,370,476	-2,925,832	- 1,444,644
7 月 July	46,643,000	1,193	2,033,470	- 2,032,277
8 月 Aug.	78,432,000	1,123,111	7,112,741	- 5,989,630
9 月 Sep.	61,572,000	5,699,784	7,479,224	- 1,779,440
10 月 Oct.	99,541,000	8,540,963	9,773,391	- 1,232,428
11 月 Nov.	73,297,000	21,443,346	25,694,110	- 4,250,764
12 月 Dec.	57,591,000	29,265,515	30,412,899	-1,147,384

Table 2. Budget Amount, Audited Amount and Actual Collection
in Recent Years (Cont. 4)

(II) Revenues from Taxes

4.House Tax

Unit : N.T.\$1

實徵數 Actual Collection			退還以前年度 歲入款 Tax Income Returned	實徵淨額 Net Actual Collection	實徵淨額 占預算數 % Net Actual Collection /Budge Amount (5/A)×100
合計 Total (2+3=1)	本年度 Current FY (2)	以前年度 Previous FY (3)			
9,198,713,352	8,997,348,726	201,364,626	8,377,361	9,190,335,991	103.8
9,408,383,446	9,159,646,344	248,737,102	15,317,628	9,393,065,818	102.8
9,897,451,617	9,511,123,127	386,328,490	7,244,799	9,890,206,818	104.5
10,008,945,199	9,801,976,281	206,968,918	11,239,378	9,997,705,821	103.7
10,107,330,035	9,936,615,687	170,714,348	16,058,978	10,091,271,057	103.5
10,147,929,725	9,971,769,272	176,160,453	7,309,474	10,140,620,251	103.5
10,307,459,162	10,167,653,129	139,806,033	11,972,825	10,295,486,337	104.0
10,627,295,631	10,486,926,494	140,369,137	126,758,102	10,500,537,529	105.0
10,873,867,433	10,640,949,149	232,918,284	8,744,070	10,865,123,363	105.8
11,869,544,305	11,765,750,542	103,793,763	9,609,521	11,859,934,784	104.0
27,081,731	16,068,138	11,013,593	443,888	26,637,843	98.8
24,800,340	14,217,022	10,583,318	112,395	24,687,945	62.5
23,166,796	16,099,824	7,066,972	290,437	22,876,359	42.7
125,941,181	114,388,406	11,552,775	506,991	125,434,190	42.7
7,127,780,163	7,118,116,976	9,663,187	1,051,019	7,126,729,144	107.3
4,221,484,562	4,214,566,201	6,918,361	485,916	4,220,998,646	107.4
64,475,836	51,739,795	12,736,041	5,351,002	59,124,834	126.8
34,506,856	30,499,160	4,007,696	692,992	33,813,864	43.1
28,123,920	17,440,882	10,683,038	47,045	28,076,875	45.6
93,621,895	83,254,975	10,366,920	56,054	93,565,841	94.0
48,887,435	45,177,565	3,709,870	471,842	48,415,593	66.1
49,673,590	44,181,598	5,491,992	99,940	49,573,650	86.1

表 2 歷年各項稅捐預算數、查定數與實徵數 (續5)

(二)稅課收入

5. 使用牌照稅

單位：新臺幣元

年度(月)別 Fiscal Year (Month)	預算數 Budget Amount (A)	查定數 Audited Amount		
		合計 Total	本年度 Current FY	以前年度 Previous FY
92 年度 FY 2003	5,886,583,000	7,185,483,058	6,142,443,434	1,043,039,624
93 年度 FY 2004	5,877,642,860	7,280,659,398	6,361,942,761	918,716,637
94 年度 FY 2005	6,096,208,000	7,375,409,176	6,508,892,037	866,517,139
95 年度 FY 2006	6,390,000,000	7,279,956,795	6,501,992,897	777,963,898
96 年度 FY 2007	6,585,000,000	7,236,551,078	6,569,504,486	667,046,592
97 年度 FY 2008	6,592,000,000	7,146,127,212	6,566,865,409	579,261,803
98 年度 FY 2009	6,500,000,000	7,003,421,917	6,486,376,074	517,045,843
99 年度 FY 2010	6,300,000,000	7,057,513,192	6,557,727,685	499,785,507
100 年度 FY 2011	6,400,000,000	7,172,227,550	6,720,258,884	451,968,666
101 年度 FY 2012	6,450,000,000	7,210,013,827	6,833,694,476	376,319,351
1 月 Jan.	80,000,000	533,302,919	98,466,284	434,836,635
2 月 Feb.	85,850,000	74,525,527	78,501,180	- 3,975,653
3 月 Mar.	363,020,000	304,527,406	308,001,256	-3,473,850
4 月 Apr.	3,350,750,000	5,727,514,776	5,731,493,137	- 3,978,361
5 月 May	1,975,760,000	216,736,743	218,163,345	- 1,426,602
6 月 June	81,000,000	-5,704,420	9,491,637	- 15,196,057
7 月 July	85,680,000	14,747,659	16,767,382	- 2,019,723
8 月 Aug.	89,429,000	17,622,378	20,983,927	- 3,361,549
9 月 Sep.	39,400,000	-492,213	11,437,921	- 11,930,134
10 月 Oct.	73,620,000	325,435,342	328,893,757	- 3,458,415
11 月 Nov.	201,990,000	3,412,668	7,092,923	- 3,680,255
12 月 Dec.	23,501,000	-1,614,958	4,401,727	-6,016,685

附註：計程車客運業自94年12月2日起免徵使用牌照稅。

Table 2. Budget Amount, Audited Amount and Actual Collection
in Recent Years (Cont. 5)

(II) Revenues from Taxes

5. Vehicle License Tax

Unit : N.T.\$1

實徵數 Actual Collection			退還以前年度 歲入款 Tax Income Returned	實徵淨額 Net Actual Collection	實徵淨額 占預算數 % Net Actual Collection /Budge Amount
合計 Total (2+3=1)	本年度 Current FY (2)	以前年度 Previous FY (3)			
6,090,223,078	5,885,871,108	204,351,970	3,110,202	6,087,112,876	103.4
6,348,330,685	6,139,733,877	208,596,808	3,575,857	6,344,754,828	107.9
6,475,038,293	6,288,700,519	186,337,774	3,521,817	6,471,516,476	106.2
6,456,855,906	6,282,770,037	174,085,869	14,106,973	6,442,748,933	100.8
6,570,266,092	6,387,577,512	182,688,580	8,119,825	6,562,146,267	99.7
6,557,721,371	6,391,932,046	165,789,325	21,283,375	6,536,437,996	99.2
6,471,544,379	6,327,495,599	144,048,780	9,534,915	6,462,009,464	99.4
6,555,896,936	6,423,796,664	132,100,272	13,827,036	6,542,069,900	103.8
6,734,678,663	6,623,516,937	111,161,726	7,912,188	6,726,766,475	105.1
6,833,177,948	6,746,233,733	86,944,215	5,451,652	6,827,726,296	105.9
105,322,421	92,310,964	13,011,457	930,002	104,392,419	130.5
89,711,271	76,203,735	13,507,536	2,184,213	87,527,058	102.0
318,053,233	306,986,846	11,066,387	809,555	317,243,678	87.4
3,206,536,744	3,198,379,854	8,156,890	443,320	3,206,093,424	95.7
2,434,985,996	2,426,019,428	8,966,568	255,335	2,434,730,661	123.2
74,950,540	68,595,895	6,354,645	293,951	74,656,589	92.2
94,878,838	88,984,623	5,894,215	182,477	94,696,361	110.5
86,344,165	80,743,173	5,600,992	82,613	86,261,552	96.5
32,521,653	28,764,188	3,757,465	46,641	32,475,012	82.4
103,371,510	98,670,253	4,701,257	102,070	103,269,440	140.3
265,655,429	262,460,209	3,195,220	38,990	265,616,439	131.5
20,846,148	18,114,565	2,731,583	82,485	20,763,663	88.4

表 2 歷年各項稅捐預算數、查定數與實徵數 (續6)

(二)稅課收入

6. 契稅

單位：新臺幣元

年度(月)別 Fiscal Year (Month)	預算數 Budget Amount (A)	查定數 Audited Amount		
		合計 Total	本年度 Current FY	以前年度 Previous FY
92 年度 FY 2003	1,513,514,000	2,066,724,723	2,021,983,642	44,741,081
93 年度 FY 2004	1,600,000,000	2,440,714,092	2,389,524,188	51,189,904
94 年度 FY 2005	1,600,000,000	2,370,146,499	2,343,929,540	26,216,959
95 年度 FY 2006	1,574,000,000	2,437,482,207	2,404,929,193	32,553,014
96 年度 FY 2007	1,620,000,000	2,505,084,139	2,471,335,039	33,749,100
97 年度 FY 2008	1,700,000,000	2,400,691,064	2,376,222,441	24,468,623
98 年度 FY 2009	1,800,000,000	2,387,423,390	2,370,494,063	16,929,327
99 年度 FY 2010	1,900,000,000	2,354,950,169	2,335,370,733	19,579,436
100 年度 FY 2011	2,000,000,000	2,024,703,077	2,004,885,156	19,817,921
101 年度 FY 2012	2,400,000,000	1,801,127,687	1,789,084,593	12,043,094
1 月 Jan.	168,000,000	152,720,144	138,966,751	13,753,393
2 月 Feb.	178,960,000	118,108,866	118,842,757	- 733,891
3 月 Mar.	210,640,000	124,869,450	124,977,456	- 108,006
4 月 Apr.	189,600,000	138,111,711	138,116,877	- 5,166
5 月 May	214,640,000	126,565,482	126,719,976	- 154,494
6 月 June	207,520,000	92,562,620	92,895,837	- 333,217
7 月 July	184,560,000	223,804,551	223,810,191	- 5,640
8 月 Aug.	207,440,000	143,792,313	143,884,396	- 92,083
9 月 Sep.	170,880,000	140,518,630	140,730,814	- 212,184
10 月 Oct.	189,120,000	179,312,809	179,342,665	- 29,856
11 月 Nov.	205,920,000	206,149,957	206,168,433	- 18,476
12 月 Dec.	272,720,000	154,611,154	154,628,440	-17,286

Table 2. Budget Amount, Audited Amount and Actual Collection
in Recent Years (Cont. 6)

(II) Revenues from Taxes

6.Deed Tax

Unit : N.T.\$1

實徵數 Actual Collection			退還以前年度 歲入款 Tax Income Returned	實徵淨額 Net Actual Collection	實徵淨額 占預算數 % Net Actual Collection /Budge Amount
合計 Total (2+3=1)	本年度 Current FY (2)	以前年度 Previous FY (3)			
2,001,597,778	1,984,423,295	17,174,483	3,839,759	1,997,758,019	132.0
2,215,404,272	2,174,423,795	40,980,477	5,706,751	2,209,697,521	138.1
2,331,208,817	2,314,331,866	16,876,951	3,072,424	2,328,136,393	145.5
2,395,511,426	2,372,214,627	23,296,799	5,651,175	2,389,860,251	151.8
2,482,531,926	2,455,891,723	26,640,203	13,565,211	2,468,966,715	152.4
2,373,419,350	2,355,450,922	17,968,428	4,332,477	2,369,086,873	139.4
2,362,740,281	2,349,557,652	13,182,629	5,738,532	2,357,001,749	130.9
2,331,574,422	2,314,250,777	17,323,645	4,427,193	2,327,147,229	122.5
2,009,354,997	1,990,445,604	18,909,393	5,023,858	2,004,331,139	100.2
1,779,320,448	1,767,832,856	11,487,592	48,554,638	1,730,765,810	72.1
109,708,763	98,223,271	11,485,492	1,201,902	108,506,861	64.6
136,427,191	135,994,881	432,310	441,794	135,985,397	76.0
130,275,357	130,275,135	222	232,373	130,042,984	61.7
134,024,675	133,893,435	131,240	197,327	133,827,348	70.6
132,677,118	132,904,746	-227,628	3,140,641	129,536,477	60.4
90,122,649	90,426,591	-303,942	41,419,655	48,702,994	23.5
218,751,217	218,722,486	28,731	1,512,224	217,238,993	117.7
154,834,099	154,892,932	-58,833	71,142	154,762,957	74.6
129,163,576	129,163,576	—	153,722	129,009,854	75.5
178,466,462	178,466,462	—	8,742	178,457,720	94.4
194,812,558	194,812,558	—	30,816	194,781,742	94.6
170,056,783	170,056,783	—	144,300	169,912,483	62.3

表 2 歷年各項稅捐預算數、查定數與實徵數 (續7)

(二)稅課收入

7. 印花稅

單位：新臺幣元

年度(月)別 Fiscal Year (Month)	預算數 Budget Amount (A)	查定數 Audited Amount		
		合計 Total	本年度 Current FY	以前年度 Previous FY
92 年度 FY 2003	3,073,446,000	3,329,632,048	3,325,720,705	3,911,343
93 年度 FY 2004	3,000,000,000	3,346,641,084	3,337,759,773	8,881,311
94 年度 FY 2005	3,124,057,000	3,622,353,250	3,615,572,362	6,780,888
95 年度 FY 2006	3,344,000,000	3,766,379,307	3,755,601,122	10,778,185
96 年度 FY 2007	3,590,000,000	3,888,454,981	3,873,555,888	14,899,093
97 年度 FY 2008	3,700,000,000	4,609,282,181	4,588,774,708	20,507,473
98 年度 FY 2009	3,800,000,000	3,925,051,668	3,906,121,491	18,930,177
99 年度 FY 2010	4,300,000,000	4,104,312,940	4,082,135,308	22,177,632
100 年度 FY 2011	4,000,000,000	4,276,000,815	4,256,320,858	19,679,957
101 年度 FY 2012	4,100,000,000	4,528,289,507	4,503,633,420	24,656,087
1 月 Jan.	591,044,000	739,784,696	714,566,286	25,218,410
2 月 Feb.	77,503,000	76,928,556	77,401,676	- 473,120
3 月 Mar.	549,578,000	566,806,249	566,794,753	11,496
4 月 Apr.	92,120,000	98,406,921	98,308,940	97,981
5 月 May	570,085,000	581,982,770	582,065,584	-82,814
6 月 June	126,740,000	97,142,956	97,199,401	- 56,445
7 月 July	618,919,000	651,438,141	651,496,647	-58,506
8 月 Aug.	139,015,000	139,105,062	139,120,960	-15,898
9 月 Sep.	589,364,000	691,375,066	691,375,066	—
10 月 Oct.	83,868,000	112,934,324	112,934,324	—
11 月 Nov.	542,009,000	633,293,502	633,278,520	14,982
12 月 Dec.	119,755,000	139,091,264	139,091,263	1

Table 2. Budget Amount, Audited Amount and Actual Collection
in Recent Years (Cont. 7)

(II) Revenues from Taxes

7. Stamp Tax

Unit : N.T.\$1

實徵數 Actual Collection			退還以前年度 歲入款 Tax Income Returned	實徵淨額 Net Actual Collection	實徵淨額 占預算數 % Net Actual Collection /Budge Amount (5/A)×100
合計 Total (2+3=1)	本年度 Current FY (2)	以前年度 Previous FY (3)			
3,320,150,514	3,319,839,274	311,240	2,128,302	3,318,022,212	108.0
3,340,833,549	3,337,591,413	3,242,136	11,613,815	3,329,219,734	111.0
3,588,199,738	3,585,960,872	2,238,866	3,545,063	3,584,654,675	114.7
3,751,018,926	3,741,648,032	9,370,894	1,713,858	3,749,305,068	112.1
3,868,754,971	3,854,892,522	13,862,449	437,622	3,868,317,349	107.8
4,575,045,907	4,555,749,565	19,296,342	1,704,717	4,573,341,190	123.6
3,908,255,404	3,890,354,445	17,900,959	2,724,686	3,905,530,718	102.8
4,082,809,119	4,061,562,012	21,247,107	492,895	4,082,316,224	94.9
4,251,545,414	4,232,189,023	19,356,391	4,783,867	4,246,761,547	106.2
4,490,891,015	4,466,449,592	24,441,423	12,319,234	4,478,571,781	109.2
724,704,496	699,771,048	24,933,448	110,499	724,593,997	122.6
75,470,362	76,006,980	-536,618	11,521	75,458,841	97.4
563,454,022	563,436,919	17,103	8,354	563,445,668	102.5
101,025,923	101,018,235	7,688	18,273	101,007,650	109.6
583,263,407	583,262,337	1,070	12,245	583,251,162	102.3
93,327,857	93,327,513	344	14,420	93,313,437	73.6
649,189,308	649,170,005	19,303	34,760	649,154,548	104.9
137,539,278	137,555,176	-15,898	100,678	137,438,600	98.9
697,285,227	697,285,227	—	7,342	697,277,885	118.3
107,045,619	107,045,619	—	11,730,565	95,315,054	113.6
633,611,777	633,596,795	14,982	—	633,611,777	116.9
124,973,739	124,973,738	1	270,577	124,703,162	104.1

表 2 歷年各項稅捐預算數、查定數與實徵數 (續8)

(二)稅課收入

8. 娛樂稅

單位：新臺幣元

年度(月)別 Fiscal Year (Month)	預算數 Budget Amount (A)	查定數 Audited Amount		
		合計 Total	本年度 Current FY	以前年度 Previous FY
92 年度 FY 2003	210,777,000	301,866,241	199,199,209	102,667,032
93 年度 FY 2004	203,851,000	290,540,571	230,696,490	59,844,081
94 年度 FY 2005	210,000,000	305,317,612	246,157,608	59,160,004
95 年度 FY 2006	238,000,000	305,881,025	245,462,724	60,418,301
96 年度 FY 2007	240,000,000	275,783,980	220,725,583	55,058,397
97 年度 FY 2008	242,000,000	268,489,788	224,280,384	44,209,404
98 年度 FY 2009	220,000,000	242,229,432	212,177,330	30,052,102
99 年度 FY 2010	210,000,000	248,327,528	228,981,000	19,346,528
100 年度 FY 2011	200,000,000	259,975,890	245,430,367	14,545,523
101 年度 FY 2012	200,000,000	239,594,695	227,269,673	12,325,022
1 月 Jan.	18,484,000	34,294,636	18,708,367	15,586,269
2 月 Feb.	16,115,000	20,689,627	20,828,982	- 139,355
3 月 Mar.	14,743,000	21,659,202	21,701,454	- 42,252
4 月 Apr.	23,453,000	15,466,713	15,989,320	- 522,607
5 月 May	15,277,000	20,446,970	20,452,582	- 5,612
6 月 June	16,318,000	21,351,866	20,884,596	467,270
7 月 July	15,799,000	15,540,282	16,943,808	- 1,403,526
8 月 Aug.	18,486,000	21,352,033	21,813,085	- 461,052
9 月 Sep.	14,130,000	17,964,575	18,329,571	- 364,996
10 月 Oct.	15,022,000	17,243,470	17,598,101	- 354,631
11 月 Nov.	15,984,000	17,089,883	17,327,357	- 237,474
12 月 Dec.	16,189,000	16,495,438	16,692,450	-197,012

Table 2. Budget Amount, Audited Amount and Actual Collection
in Recent Years (Cont. 8)

(II) Revenues from Taxes

8. Amusement Tax

Unit : N.T.\$1

實徵數 Actual Collection			退還以前年度 歲入款 Tax Income Returned (4)	實徵淨額 Net Actual Collection (1-4=5)	實徵淨額 占預算數 % Net Actual Collection /Budge Amount (5/A)×100
合計 Total (2+3=1)	本年度 Current FY (2)	以前年度 Previous FY (3)			
239,032,108	187,440,041	51,592,067	9,170	239,022,938	113.4
226,986,463	220,654,104	6,332,359	121,561	226,864,902	111.3
242,091,551	237,515,640	4,575,911	4,027	242,087,524	115.3
244,097,516	238,934,679	5,162,837	97,763	243,999,753	102.5
216,736,034	212,172,220	4,563,814	19,492,764	197,243,270	82.2
221,995,693	218,593,813	3,401,880	9,506,701	212,488,992	87.8
210,098,246	207,121,900	2,976,346	75,284	210,022,962	95.5
226,941,170	224,986,040	1,955,130	68,614	226,872,556	108.0
244,111,111	242,285,021	1,826,090	303,664	243,807,447	121.9
224,615,319	222,583,805	2,031,514	477,451	224,137,868	112.1
18,836,828	18,085,607	751,221	2,238	18,834,590	101.9
20,767,001	20,458,587	308,414	8,730	20,758,271	128.8
20,365,792	20,071,847	293,945	6,719	20,359,073	138.1
16,427,059	16,242,700	184,359	9,140	16,417,919	70.0
21,016,274	20,890,999	125,275	—	21,016,274	137.6
20,729,082	19,395,821	1,333,261	—	20,729,082	127.0
17,155,674	18,352,683	-1,197,009	444,861	16,710,813	105.8
19,299,046	19,191,569	107,477	—	19,299,046	104.4
19,457,854	19,404,587	53,267	126	19,457,728	137.7
18,378,238	18,348,652	29,586	5,637	18,372,601	122.3
16,913,797	16,886,172	27,625	—	16,913,797	105.8
15,268,674	15,254,581	14,093	—	15,268,674	94.3

表 2 歷年各項稅捐預算數、查定數與實徵數 (續9)

(二)稅課收入

9. 九年國民義務教育附徵教育經費

單位：新臺幣元

(1)小計

年度(月)別 Fiscal Year (Month)	預算數 Budget Amount (A)	查定數 Audited Amount		
		合計 Total	本年度 Current FY	以前年度 Previous FY
92 年度 FY 2003	—	39,039,909	111,764	38,928,145
93 年度 FY 2004	—	31,816,227	5,444	31,810,783
94 年度 FY 2005	—	26,775,123	28,543	26,746,580
95 年度 FY 2006	—	21,939,547	—	21,939,547
96 年度 FY 2007	—	16,530,226	—	16,530,226
97 年度 FY 2008	—	12,539,866	—	12,539,866
98 年度 FY 2009	—	8,274,576	—	8,274,576
99 年度 FY 2010	—	4,999,750	—	4,999,750
100 年度 FY 2011	—	2,226,710	—	2,226,710
101 年度 FY 2012	—	1,200,781	—	1,200,781
1 月 Jan.	—	1,882,669	—	1,882,669
2 月 Feb.	—	- 31,596	—	- 31,596
3 月 Mar.	—	- 212,313	—	- 212,313
4 月 Apr.	—	- 80,172	—	- 80,172
5 月 May	—	—	—	—
6 月 June	—	- 5,852	—	- 5,852
7 月 July	—	—	—	—
8 月 Aug.	—	- 162,420	—	- 162,420
9 月 Sep.	—	- 43,587	—	- 43,587
10 月 Oct.	—	—	—	—
11 月 Nov.	—	-138,675	—	- 138,675
12 月 Dec.	—	-7,273	—	-7,273

Table 2. Budget Amount, Audited Amount and Actual Collection
in Recent Years (Cont. 9)

(II) Revenues from Taxes

9. Education Surtax

(1)Subtotal

Unit : N.T.\$1

實徵數 Actual Collection			退還以前年度 歲入款 Tax Income Returned (4)	實徵淨額 Net Actual Collection (1-4=5)	實徵淨額 占預算數 % Net Actual Collection /Budge Amount (5/A)×100
合計 Total (2+3=1)	本年度 Current FY (2)	以前年度 Previous FY (3)			
3,054,319	110,532	2,943,787	78,424	2,975,895	--
1,921,591	5,444	1,916,147	1,515	1,920,076	--
2,913,698	28,543	2,885,155	9,414	2,904,284	--
1,303,967	—	1,303,967	38,877	1,265,090	--
1,386,379	—	1,386,379	12,263	1,374,116	--
755,593	—	755,593	—	755,593	--
355,000	—	355,000	1,231,783	- 876,783	--
668,897	—	668,897	10,629,176	- 9,960,279	--
344,041	—	344,041	341,047	2,994	--
304,361	—	304,361	40,452	263,909	--
—	—	—	22,017	- 22,017	--
275,886	—	275,886	—	275,886	--
21,319	—	21,319	14,603	6,716	--
—	—	—	—	—	--
—	—	—	—	—	--
—	—	—	2,349	-2,349	--
4,214	—	4,214	—	4,214	--
—	—	—	—	—	--
—	—	—	—	—	--
—	—	—	—	—	--
2,942	—	2,942	1,483	1,459	--

表 2 歷年各項稅捐預算數、查定數與實徵數 (續10)

(二)稅課收入

9. 九年國民義務教育附徵教育經費

單位：新臺幣元

(2)房屋稅

年度(月)別 Fiscal Year (Month)	預算數 Budget Amount (A)	查定數 Audited Amount		
		合計 Total	本年度 Current FY	以前年度 Previous FY
92 年度 FY 2003	—	33,413,248	93,128	33,320,120
93 年度 FY 2004	—	26,823,992	5,019	26,818,973
94 年度 FY 2005	—	22,852,091	28,543	22,823,548
95 年度 FY 2006	—	18,474,872	—	18,474,872
96 年度 FY 2007	—	13,738,671	—	13,738,671
97 年度 FY 2008	—	10,259,504	—	10,259,504
98 年度 FY 2009	—	7,692,721	—	7,692,721
99 年度 FY 2010	—	4,894,676	—	4,894,676
100 年度 FY 2011	—	2,213,603	—	2,213,603
101 年度 FY 2012	—	1,200,781	—	1,200,781
1 月 Jan.	—	1,869,562	—	1,869,562
2 月 Feb.	—	- 20,298	—	- 20,298
3 月 Mar.	—	- 217,777	—	- 217,777
4 月 Apr.	—	- 80,172	—	- 80,172
5 月 May	—	—	—	—
6 月 June	—	- 5,852	—	- 5,852
7 月 July	—	—	—	—
8 月 Aug.	—	- 162,420	—	- 162,420
9 月 Sep.	—	- 43,587	—	- 43,587
10 月 Oct.	—	—	—	—
11 月 Nov.	—	- 138,675	—	- 138,675
12 月 Dec.	—	—	—	—

Table 2. Budget Amount, Audited Amount and Actual Collection
in Recent Years (Cont. 10)

(II) Revenues from Taxes

9. Education Surtax

(2) House Tax

Unit : N.T.\$1

實徵數 Actual Collection			退還以前年度 歲入款 Tax Income Returned (4)	實徵淨額 Net Actual Collection (1-4=5)	實徵淨額 占預算數 % Net Actual Collection /Budge Amount (5/A)×100
合計 Total (2+3=1)	本年度 Current FY (2)	以前年度 Previous FY (3)			
2,960,859	91,896	2,868,963	78,424	2,882,435	--
1,754,868	5,019	1,749,849	1,515	1,753,353	--
2,831,690	28,543	2,803,147	9,414	2,822,276	--
1,251,965	—	1,251,965	38,877	1,213,088	--
1,307,026	—	1,307,026	11,356	1,295,670	--
735,622	—	735,622	—	735,622	--
343,930	—	343,930	1,231,783	-887,853	--
664,650	—	664,650	10,629,176	-9,964,526	--
344,041	—	344,041	341,047	2,994	--
304,361	—	304,361	40,452	263,909	--
—	—	—	22,017	- 22,017	--
275,886	—	275,886	—	275,886	--
21,319	—	21,319	14,603	6,716	--
—	—	—	—	—	--
—	—	—	—	—	--
—	—	—	2,349	-2,349	--
4,214	—	4,214	—	4,214	--
—	—	—	—	—	--
—	—	—	—	—	--
—	—	—	—	—	--
2,942	—	2,942	1,483	1,459	--

表 2 歷年各項稅捐預算數、查定數與實徵數 (續11)

(二)稅課收入

9. 九年國民義務教育附徵教育經費

單位：新臺幣元

(3)娛樂稅

年度(月)別 Fiscal Year (Month)	預算數 Budget Amount (A)	查定數 Audited Amount		
		合計 Total	本年度 Current FY	以前年度 Previous FY
92 年度 FY 2003	—	5,626,661	18,636	5,608,025
93 年度 FY 2004	—	4,992,235	425	4,991,810
94 年度 FY 2005	—	3,923,032	—	3,923,032
95 年度 FY 2006	—	3,464,675	—	3,464,675
96 年度 FY 2007	—	2,791,555	—	2,791,555
97 年度 FY 2008	—	2,280,362	—	2,280,362
98 年度 FY 2009	—	581,855	—	581,855
99 年度 FY 2010	—	105,074	—	105,074
100 年度 FY 2011	—	13,107	—	13,107
101 年度 FY 2012	—	—	—	—
1 月 Jan.	—	13,107	—	13,107
2 月 Feb.	—	-11,298	—	-11,298
3 月 Mar.	—	5,464	—	5,464
4 月 Apr.	—	—	—	—
5 月 May	—	—	—	—
6 月 June	—	—	—	—
7 月 July	—	—	—	—
8 月 Aug.	—	—	—	—
9 月 Sep.	—	—	—	—
10 月 Oct.	—	—	—	—
11 月 Nov.	—	—	—	—
12 月 Dec.	—	-7,273	—	-7,273

表 2 歷年各項稅捐預算數、查定數與實徵數 (續12)

(三)工程受益費

單位：新臺幣元

年度(月)別 Fiscal Year (Month)	預算數 Budget Amount (A)	查定數 Audited Amount		
		合計 Total	本年度 Current FY	以前年度 Previous FY
92 年度 FY 2003	—	5,403,633	—	5,403,633
93 年度 FY 2004	—	3,879,407	—	3,879,407
94 年度 FY 2005	—	73,882	—	73,882
95 年度 FY 2006	—	45,351	—	45,351
96 年度 FY 2007	—	116,439	—	116,439
97 年度 FY 2008	—	—	—	—
98 年度 FY 2009	—	—	—	—
99 年度 FY 2010	—	—	—	—
100 年度 FY 2011	—	42,197	—	42,197
101 年度 FY 2012	—	—	—	—
1 月 Jan.	—	—	—	—
2 月 Feb.	—	—	—	—
3 月 Mar.	—	—	—	—
4 月 Apr.	—	—	—	—
5 月 May	—	—	—	—
6 月 June	—	—	—	—
7 月 July	—	—	—	—
8 月 Aug.	—	—	—	—
9 月 Sep.	—	—	—	—
10 月 Oct.	—	—	—	—
11 月 Nov.	—	—	—	—
12 月 Dec.	—	—	—	—

表 2 歷年各項稅捐預算數、查定數與實徵數 (續13)

(四)罰鍰收入

單位：新臺幣元

年度(月)別 Fiscal Year (Month)	預算數 Budget Amount (A)	查定數 Audited Amount		
		合計 Total	本年度 Current FY	以前年度 Previous FY
92 年度 FY 2003	109,887,000	510,907,382	111,224,099	399,683,283
93 年度 FY 2004	123,021,000	489,809,033	117,152,766	372,656,267
94 年度 FY 2005	188,000,000	464,605,562	118,648,479	345,957,083
95 年度 FY 2006	183,000,000	437,452,233	72,706,354	364,745,879
96 年度 FY 2007	183,000,000	442,108,236	126,466,198	315,642,038
97 年度 FY 2008	204,000,000	475,339,022	162,206,174	313,132,848
98 年度 FY 2009	201,000,000	494,714,768	157,439,459	337,275,309
99 年度 FY 2010	155,000,000	547,722,155	204,193,586	343,528,569
100 年度 FY 2011	154,000,000	563,414,313	133,481,505	429,932,808
101 年度 FY 2012	135,000,000	496,099,434	98,656,201	397,443,233
1 月 Jan.	5,465,000	391,035,184	8,821,609	382,213,575
2 月 Feb.	10,960,000	6,570,680	2,687,828	3,882,852
3 月 Mar.	13,005,000	6,588,811	2,735,985	3,852,826
4 月 Apr.	10,060,000	5,759,051	4,070,841	1,688,210
5 月 May	17,840,000	17,313,141	15,374,675	1,938,466
6 月 June	12,170,000	5,567,728	7,323,747	-1,756,019
7 月 July	8,115,000	9,985,301	6,529,117	3,456,184
8 月 Aug.	12,015,000	5,942,547	4,515,596	1,426,951
9 月 Sep.	15,795,000	8,589,901	6,701,640	1,888,261
10 月 Oct.	6,950,000	5,996,979	7,653,536	-1,656,557
11 月 Nov.	9,895,000	11,238,879	11,487,553	-248,674
12 月 Dec.	12,730,000	21,511,232	20,754,074	757,158

Table 2. Budget Amount, Audited Amount and Actual Collection
in Recent Years (Cont. 13)

(IV) Punitive Fine Revenue

Unit : N.T.\$1

實徵數 Actual Collection			退還以前年度 歲入款 Tax Income Returned (4)	實徵淨額 Net Actual Collection (1-4=5)	實徵淨額 占預算數 % Net Actual Collection /Budge Amount (5/A)×100
合計 Total (2+3=1)	本年度 Current FY (2)	以前年度 Previous FY (3)			
203,809,102	57,071,525	146,737,577	202,799,526	1,009,576	0.9
227,139,704	93,764,480	133,375,224	47,722,560	179,417,144	145.8
223,858,767	67,694,444	156,164,323	13,162,067	210,696,700	112.1
230,087,703	53,836,140	176,251,563	4,777,848	225,309,855	123.1
191,975,376	58,776,047	133,199,329	6,943,632	185,031,744	101.1
191,887,419	64,189,183	127,698,236	8,921,665	182,965,754	89.7
199,652,733	58,490,467	141,162,266	47,262,251	152,390,482	75.8
165,963,949	62,178,322	103,785,627	105,644,011	60,319,938	38.9
188,127,746	59,663,707	128,464,039	27,995,613	160,132,133	104.0
130,740,906	43,159,508	87,581,398	12,973,313	117,767,593	87.2
14,110,862	1,168,659	12,942,203	722,788	13,388,074	245.0
11,089,815	1,281,522	9,808,293	637,043	10,452,772	95.4
10,524,777	946,339	9,578,438	430,041	10,094,736	77.6
9,895,286	882,524	9,012,762	173,123	9,722,163	96.6
12,904,826	6,515,878	6,388,948	1,151,541	11,753,285	65.9
8,899,671	3,717,336	5,182,335	1,378,795	7,520,876	61.8
11,194,354	4,024,012	7,170,342	1,078,894	10,115,460	124.7
8,666,023	3,656,697	5,009,326	2,380,099	6,285,924	52.3
9,915,040	3,862,675	6,052,365	443,351	9,471,689	60.0
7,154,697	3,640,702	3,513,995	327,599	6,827,098	98.2
9,541,716	5,205,449	4,336,267	673,196	8,868,520	89.6
16,843,839	8,257,715	8,586,124	3,576,843	13,266,996	104.2

表 2 歷年各項稅捐預算數、查定數與實徵數 (續14完)

(五)規費收入

單位：新臺幣元

監證費

年度(月)別 Fiscal Year (Month)	預算數 Budget Amount (A)	查定數 Audited Amount		
		合計 Total	本年度 Current FY	以前年度 Previous FY
92 年度 FY 2003	—	1,038,564	15,968	1,022,596
93 年度 FY 2004	—	593	—	593
94 年度 FY 2005	—	—	—	—
95 年度 FY 2006	—	—	—	—
96 年度 FY 2007	—	4,097	—	4,097
97 年度 FY 2008	—	—	—	—
98 年度 FY 2009	—	149,080	—	149,080
99 年度 FY 2010	—	—	—	—
100 年度 FY 2011	—	—	—	—
101 年度 FY 2012	—	—	—	—
1 月 Jan.	—	—	—	—
2 月 Feb.	—	—	—	—
3 月 Mar.	—	—	—	—
4 月 Apr.	—	—	—	—
5 月 May	—	—	—	—
6 月 June	—	—	—	—
7 月 July	—	—	—	—
8 月 Aug.	—	—	—	—
9 月 Sep.	—	—	—	—
10 月 Oct.	—	—	—	—
11 月 Nov.	—	—	—	—
12 月 Dec.	—	—	—	—

表 3 各項稅捐納庫數

(一)歷年別

單位：新臺幣元

年 度 (月) 別 Fiscal Year (Month)	實 徵 數 ① Actual Collection	納 庫 數	
		合 計 Total	國庫 Nation Treasury
92 年 度 FY 2003 ③	52,727,536,378	52,722,373,825	—
93 年 度 FY 2004	58,546,075,931	58,545,599,695	—
94 年 度 FY 2005	60,821,499,933	60,821,258,612	—
95 年 度 FY 2006 ④	59,935,082,828	59,934,140,690	—
96 年 度 FY 2007 ⑤	62,211,212,658	62,211,212,658	—
97 年 度 FY 2008 ⑥	57,349,343,608	57,349,343,608	—
98 年 度 FY 2009	57,906,303,509	57,906,010,169	—
99 年 度 FY 2010 ⑦	61,412,898,686	61,412,898,686	—
100 年 度 FY 2011	62,364,742,945	62,364,742,945	—
101 年 度 FY 2012 ⑧	62,751,393,789	62,751,393,789	—
1 月 Jan.	2,236,996,247	1,817,072,452	—
2 月 Feb.	1,577,194,952	1,640,302,109	—
3 月 Mar.	2,312,602,213	2,131,142,443	—
4 月 Apr.	4,981,008,591	4,342,542,766	—
5 月 May	11,927,093,717	9,284,268,985	—
6 月 June	6,078,881,268	9,646,708,196	—
7 月 July	2,945,936,191	2,679,566,824	—
8 月 Aug.	1,595,888,157	1,901,037,064	—
9 月 Sep.	1,961,741,915	1,999,744,942	—
10 月 Oct.	1,844,089,088	1,455,099,708	—
11 月 Nov.	13,633,356,427	8,366,445,232	—
12 月 Dec.	11,656,605,023	17,487,463,068	—

資料來源：依據徵課會計報告編製。

附 註：①自99年度起實徵數未含實物抵繳稅款(以遞延收入入帳)。

②年度之未納庫數係歷年實物抵繳稅款累計數。

③以前年度實物抵繳3,677元於92年度變賣納庫。

④以前年度實物抵繳23,648元於95年度變賣納庫。

Table 3. Taxation Forwarded to Treasury

(I) Fiscal Year

Unit : N.T.\$1

Pay to Treasury			未納庫數 Unpay to ② Treasury
中央統籌專戶 Distribution of Central Gov't	重建基金庫 Reconstruction Fund	市庫 The Municipal Treasury	
—	—	52,722,373,825	57,278,044
—	—	58,545,599,695	57,754,280
—	—	60,821,258,612	57,995,601
—	—	59,934,140,690	58,914,091
—	—	62,211,212,658	58,887,328
—	—	57,349,343,608	58,886,859
—	—	57,906,010,169	59,180,199
—	—	61,412,898,686	59,145,876
—	—	62,364,742,945	59,145,876
—	—	62,751,393,789	59,489,460
—	—	1,817,072,452	419,923,795
—	—	1,640,302,109	356,816,638
—	—	2,131,142,443	538,276,408
—	—	4,342,542,766	1,176,742,233
—	—	9,284,268,985	3,819,566,965
—	—	9,646,708,196	251,740,037
—	—	2,679,566,824	518,109,404
—	—	1,901,037,064	212,960,497
—	—	1,999,744,942	174,957,470
—	—	1,455,099,708	563,946,850
—	—	8,366,445,232	5,830,858,045
—	—	17,487,463,068	—

⑤以前年度實物抵繳26,763元於96年度變賣納庫。

⑥以前年度實物抵繳469元於97年度變賣納庫。

⑦以前年度實物抵繳34,323元於99年度變賣納庫。

⑧101年度未納庫數含實物抵繳343,584元。

表 3 各項稅捐納庫數(續)

(二)稅目別
101年度

單位：新臺幣元

稅目別 Item of Tax	實徵數 Actual Collection	納庫數 Pay to Treasury			
		合計 Total	國庫 The Nation Treasury	中央統籌專戶 Distribution of Central Gov't	重建基金庫 Reconstruction Fund
總計 Grand Total	62,751,393,789	62,751,393,789	—	—	—
地價稅 Land Value Tax	20,748,021,644	20,748,021,644	—	—	—
土地增值稅 Land value Increment Tax	16,674,777,843	16,674,777,843	—	—	—
房屋稅 House Tax	11,869,544,305	11,869,544,305	—	—	—
使用牌照稅 Vehicle License Tax	6,833,177,948	6,833,177,948	—	—	—
契稅 Deed Tax	1,779,320,448	1,779,320,448	—	—	—
印花稅 Stamp Tax	4,490,891,015	4,490,891,015	—	—	—
娛樂稅 Amusement Tax	224,615,319	224,615,319	—	—	—
教育經費 Education Surtax	304,361	304,361	—	—	—
工程受益費 Construction Benefit Fee	—	—	—	—	—
罰鍰收入 Punitive Fine Revenue	130,740,906	130,740,906	—	—	—
規費收入 Fees Revenue	—	—	—	—	—

Table 3. Taxation Forwarded to Treasury (Cont.)

(II) Item of Tax				
FY 2012				
Unit : N.T.\$1				
退還以前年度歲入款 Tax Income Returned				
市 庫 The Municipal Treasury	合 計 Total	國 庫 The Nation Treasury	中央統籌專戶 Distribution of Central Gov't	市 庫 The Municipal Treasury
62,751,393,789	444,487,791	—	—	444,487,791
20,748,021,644	77,497,739	—	—	77,497,739
16,674,777,843	277,563,791	—	—	277,563,791
11,869,544,305	9,609,521	—	—	9,609,521
6,833,177,948	5,451,652	—	—	5,451,652
1,779,320,448	48,554,638	—	—	48,554,638
4,490,891,015	12,319,234	—	—	12,319,234
224,615,319	477,451	—	—	477,451
304,361	40,452	—	—	40,452
—	—	—	—	—
130,740,906	12,973,313	—	—	12,973,313
—	—	—	—	—

表 4 歷年各項稅捐實徵淨額及指數

基 比：100年度=100

環 比：上年度=100

分 配 比：各年度總計=100

單位：新臺幣千元

稅 目 別 Item of Tax	92年度 FY2003	93年度 FY2004			94年度	
	實徵淨額 Net Actual Collection	實徵淨額 Net Actual Collection	指數 Index		分配比 Shares	實徵淨額 Net Actual Collection
			基 比 Fixed Index	環 比 Link Index		
總 計 Grand Total	52,015,208	58,044,127	93.4	111.6	100.0	60,543,000
稅 課 收 入 Revenues from Taxes	52,007,761	57,860,878	93.3	111.3	99.7	60,332,240
地 價 稅 Land Value Tax	16,858,390	17,105,907	83.4	101.5	29.5	17,557,773
土地增值稅 Land Value Increment Tax	14,314,143	19,249,448	110.6	134.5	33.2	20,254,961
房 屋 稅 House Tax	9,190,336	9,393,066	86.5	102.2	16.2	9,890,207
使用牌照稅 Vehicle License Tax	6,087,113	6,344,755	94.3	104.2	10.9	6,471,516
契 稅 Deed Tax	1,997,758	2,209,697	110.2	110.6	3.8	2,328,136
印 花 稅 Stamp Tax	3,318,022	3,329,220	78.4	100.3	5.7	3,584,655
娛 樂 稅 Amusement Tax	239,023	226,865	93.1	94.9	0.4	242,088
教育經費 Education Surtax	2,976	1,920	64,000.0	64.5	0.0	2,904
工程受益費 Construction Benefit Fee	5,401	3,862	9,195.2	71.5	0.0	74
罰 鍰 收 入 Punitive Fine Revenue	1,010	179,417	112.0	17,771.5	0.3	210,697
規 費 收 入 Fees Revenue	1,037	- 30	--	--	- 0.0	- 11
契稅監證費 Fees	1,037	- 30	--	--	- 0.0	- 11

資料來源：依據徵課會計報告編製。

Table 4. Net Amount Remitted and Index in Recent Years

Fixed Index:FY2011=100

Link Index>Last Year=100

Shares:Total=100

Unit:N.T.\$1,000

FY 2005			95年度 FY2006				96年度 FY2007				
指數 Index		分配比 Shares	實徵淨額 Net Actual Collection	指數 Index		分配比 Shares	實徵淨額 Net Actual Collection	指數 Index		分配比 Shares	
基 比 Fixed Index	環 比 Link Index			基 比 Fixed Index	環 比 Link Index			基 比 Fixed Index	環 比 Link Index		
97.4	104.3	100.0	59,559,142	95.8	98.4	100.0	61,880,951	99.6	103.9	100.0	
97.3	104.3	99.7	59,333,787	95.7	98.3	99.6	61,695,799	99.5	104.0	99.7	
85.6	102.6	29.0	17,900,813	87.3	102.0	30.1	19,468,697	94.9	108.8	31.5	
116.4	105.2	33.5	18,608,089	106.9	91.9	31.2	19,037,783	109.4	102.3	30.8	
91.0	105.3	16.3	9,997,706	92.0	101.1	16.8	10,091,271	92.9	100.9	16.3	
96.2	102.0	10.7	6,442,749	95.8	99.6	10.8	6,562,146	97.6	101.9	10.6	
116.2	105.4	3.9	2,389,860	119.2	102.7	4.0	2,468,967	123.2	103.3	4.0	
84.4	107.7	5.9	3,749,305	88.3	104.6	6.3	3,868,318	91.1	103.2	6.2	
99.3	106.7	0.4	244,000	100.1	100.8	0.4	197,243	80.9	80.8	0.3	
96,800.0	151.3	0.0	1,265	42,166.7	43.6	0.0	1,374	45,800.0	108.6	0.0	
176.2	1.9	0.0	45	107.1	60.8	0.0	116	276.2	257.8	0.0	
131.6	117.4	0.3	225,310	140.7	106.9	0.4	185,032	115.5	82.1	0.3	
--	--	-0.0	--	--	--	--	4	--	--	0.0	
--	--	-0.0	--	--	--	--	4	--	--	0.0	

表 4 歷年各項稅捐實徵淨額及指數 (續)

基 比：100年度=100

環 比：上年度=100

分配 比：各年度總計=100

單位：新臺幣千元

稅目別 Item of Tax	97年度 FY2008				98年度 FY2009				99年度
	實徵淨額 Net Actual Collection	指數 Index		分配比 Shares	實徵淨額 Net Actual Collection	指數 Index		分配比 Shares	實徵淨額 Net Actual Collection
		基比 Fixed Index	環比 Link Index			基比 Fixed Index	環比 Link Index		
總 計 Grand Total	56,753,478	91.3	91.7	100.0	57,498,023	92.5	101.3	100.0	60,905,235
稅 課 收 入 Revenues from Taxes	56,570,534	91.2	91.7	99.7	57,345,484	92.5	101.4	99.7	60,844,915
地 價 稅 Land Value Tax	19,188,394	93.6	98.6	33.8	18,702,394	91.2	97.5	32.5	20,291,042
土地增值稅 Land Value Increment Tax	13,549,409	77.8	71.2	23.9	15,413,916	88.5	113.8	26.8	16,884,890
房 屋 稅 House Tax	10,140,620	93.3	100.5	17.9	10,295,486	94.8	101.5	17.9	10,500,537
使用牌照稅 Vehicle License Tax	6,536,438	97.2	99.6	11.5	6,462,009	96.1	98.9	11.2	6,542,070
契 稅 Deed Tax	2,369,087	118.2	96.0	4.2	2,357,002	117.6	99.5	4.1	2,327,147
印 花 稅 Stamp Tax	4,573,341	107.7	118.2	8.0	3,905,531	92.0	85.4	6.8	4,082,316
娛 樂 稅 Amusement Tax	212,489	87.2	107.7	0.4	210,023	86.1	98.8	0.4	226,873
教育經費 Education Surtax	756	25,200.0	55.0	0.0	- 877	--	--	-0.0	- 9,960
工程受益費 Construction Benefit Fee	- 22	--	--	- 0.0	--	--	--	--	--
罰 鍰 收 入 Punitive Fine Revenue	182,966	114.3	98.9	0.3	152,390	95.2	83.3	0.3	60,320
規 費 收 入 Fees Revenue	--	--	--	--	149	--	--	0.0	--
契稅監證費 Fees	--	--	--	--	149	--	--	0.0	--

表 5 本處各項稅捐稽徵成本①②

Table 5. Cost of Tax Levying ①②

年度及稅目別 Fiscal Year & Item of Tax	實徵淨額 (千元) Net Actual Collection (N.T.\$1000) (1)	實支經費 (元) Expense (N.T.\$1) (2)	每千元成本 (元) Cost of \$1,000 (2)/(1)
92 年度 FY 2003	52,007,761	933,098,843	17.9415
93 年度 FY 2004	57,860,878	931,864,861	16.1053
94 年度 FY 2005	60,332,240	896,828,571	14.8648
95 年度 FY 2006	59,333,787	914,484,276	15.4125
96 年度 FY 2007	61,695,799	898,794,972	14.5682
97 年度 FY 2008	56,570,534	894,798,178	15.8174
98 年度 FY 2009	57,345,484	894,489,263	15.5983
99 年度 FY 2010	60,844,915	899,839,885	14.7891
100 年度 FY 2011	61,999,268	888,513,303	14.3310
101 年度 FY 2012	62,189,138	893,122,419	14.3614
地價稅 Land Value Tax	20,670,524	264,170,686	12.7801
土地增值稅 Land Value Increment Tax	16,397,214	196,546,554	11.9866
房屋稅 House Tax	11,860,199	214,811,307	18.1119
使用牌照稅 Vehicle License Tax	6,827,726	106,024,660	15.5285
契稅 Deed Tax	1,730,766	47,399,260	27.3863
印花稅 Stamp Tax	4,478,571	36,173,119	8.0769
娛樂稅 Amusement Tax	224,138	27,996,833	124.9089

資料來源：根據本處會計室資料編製。

附註：①依據財政部賦稅署擬訂之各稅稽徵成本計算方式一致性規定說明書之編算原則核計。

②房屋稅與娛樂稅實徵淨額含九年國民義務教育附徵教育經費。

參、稅源及其他

III . Tax Sources and Others

表 6 地價稅稅源

單位 { 面積：公頃
金額：新臺幣千元

年別及稅地種類別 Year & Classification		戶數 No. of House	筆數 Plots
96	年 2007	810,293	1,734,899
97	年 2008	822,864	1,760,008
98	年 2009	834,400	1,782,383
99	年 2010	843,247	1,814,594
100	年 2011	852,009	1,843,386
101	年 2012	860,251	1,868,226
公	有 Public	312	110,922
一	般 土 地 Regular Land	293	101,973
	自用住宅用地 Self-use Residence Land	11	181
	工礦業等用地 Specific Business Land	—	119
	公共設施保留地 Land Reserved for Public Facilities	8	8,649
私	有 Private	859,939	1,757,304
一	般 土 地 Regular Land	373,840	813,627
	第一級 Level 1	370,335	773,512
	第二級 Level 2	2,999	26,458
	第三級 Level 3	264	2,844
	第四級 Level 4	88	1,453
	第五級 Level 5	37	694
	第六級 Level 6	117	8,666
	自用住宅用地 Self-use Residence Land	483,560	878,880
	都市土地 Urban Land	483,560	878,880
	非都市土地 Non-Urban Land	—	—
	工礦業等用地 Specific Business	34	1,806
	公共設施保留地 Land Reserved for Public Facilities	2,505	62,991

資料來源：根據本處財產稅科資料編製。

Table 6. Sources of Land Value Tax

課 稅 面 積 Taxed Area	課 稅 地 價 Taxed Land Value	Uni
		{ Area : Hectare Amount : N.T.\$1,000
		地 價 稅 額 Land Value Tax
5,026.9932	1,913,499,569	19,048,178
4,861.1691	1,906,412,830	18,691,962
4,835.7439	1,911,687,078	18,425,014
4,959.2458	2,091,696,127	20,056,339
4,915.9018	2,087,899,910	20,131,896
5,034.7634	2,096,510,787	20,339,436
420.6052	157,495,462	1,506,856
386.5852	146,536,014	1,465,360
21.5243	6,394,844	12,790
1.3077	329,671	3,297
11.1879	4,234,933	25,410
4,614.1581	1,939,015,325	18,832,580
2,384.7751	997,235,986	16,559,207
1,559.2822	617,007,706	6,170,066
397.6029	149,994,901	1,877,135
85.7312	39,743,800	666,951
47.4532	26,885,286	588,337
26.0819	15,759,711	414,492
268.6235	147,844,581	6,842,226
2,033.1030	885,854,415	1,771,681
2,033.1030	885,854,415	1,771,681
—	—	—
98.8588	41,535,863	415,359
97.4211	14,389,061	86,333

表 7 土地增值稅稅源

單位 { 面積：公頃
金額：新臺幣千元

年度及稅率別 Fiscal Year & Rate of Tax	筆數 Plots	面積 Area	移轉現值 Present Value of Transfer	調整後原地價 Originally Declared Value After Adjustment	
92 年 度 FY2003	124,206	750.0898	475,692,440	237,347,214	
93 年 度 FY2004	130,387	812.4215	489,425,596	262,757,015	
94 年 度 FY2005	132,593	683.7837	465,562,997	286,530,211	
95 年 度 FY2006	137,910	610.5693	452,335,486	311,509,340	
96 年 度 FY2007	133,614	598.8314	449,354,075	309,302,178	
97 年 度 FY2008	134,635	513.1119	418,194,495	299,218,322	
98 年 度 FY2009	124,589	415.3626	411,747,421	286,607,620	
99 年 度 FY2010	138,294	509.0032	440,310,323	305,753,138	
100 年 度 FY2011	127,170	436.1678	382,853,776	252,580,246	
101 年 度 FY2012	102,169	334.1813	321,992,197	193,999,469	
自用住宅用地 稅率10%	Self-use Residence Land (Rate 10%)	11,324	24.6622	44,735,896	19,642,922
一般用地	Regular Land	57,473	112.8236	178,917,061	118,340,308
稅率20%	Rate 20%	46,776	84.9161	146,027,536	112,986,984
稅率30%	Rate 30%	2,314	4.7909	5,504,753	2,297,837
稅率40%	Rate 40%	8,341	23.1166	27,384,772	3,055,487
其他	Others	42	0.0000	—	—
免稅地	Exempt Land	33,372	196.6955	98,339,240	56,016,239
公有土地	Public Land	1,116	4.1101	9,585,477	2,103,490
私有土地	Private Land	32,256	192.5854	88,753,763	53,912,749

資料來源：根據本處財產稅科資料編製。

Table 7. Sources of Land Value Increment Tax

Unit { Area : Hectare Amount : N.T.\$1,000					
改良土地費用 Land Improvement Cost	漲價總數額 Cross Amount of Land Value Increment	查定稅額 Assessment Tax	增繳地價稅 Supplemental Payment of Land Value Tax	減徵稅額 Reduction	應納稅額 Tax Payable
802,674	237,542,552	18,893,504	804,591	1,045,207	17,043,706
1,229,670	225,438,911	32,789,855	1,495,956	1,420,352	29,873,547
1,675,612	177,357,174	25,564,553	1,111,589	1,262,153	23,190,811
4,241,536	136,584,610	20,497,584	908,315	1,319,686	18,269,583
2,264,726	137,787,171	22,179,717	946,091	1,002,950	20,230,676
1,266,847	117,709,326	16,157,946	611,854	428,479	15,117,613
2,003,969	123,135,832	17,240,793	684,454	709,141	15,847,198
1,429,814	133,127,371	19,232,065	773,734	861,337	17,596,994
659,623	129,613,907	18,695,238	727,894	646,878	17,320,466
261,858	127,730,870	17,406,309	705,764	550,475	16,150,070
14,250	25,078,724	2,507,868	119,597	29,272	2,358,999
212,793	60,363,960	14,898,441	586,167	521,203	13,791,071
5,700	33,034,852	6,612,258	176,849	121,197	6,314,212
2,217	3,204,699	723,036	28,721	43,569	650,746
204,876	24,124,409	7,552,020	380,597	356,437	6,814,986
—	—	11,127	—	—	11,127
34,815	42,288,186	—	—	—	—
—	7,481,987	—	—	—	—
34,815	34,806,199	—	—	—	—

表 8 房 屋 稅 稅 源

單位 { 面積：平方公尺
金額：新臺幣千元

年度別、構造及使用別 Fiscal Year& Structure & Use	合計 Total		
	戶 數 Number of House	面 積 Area	現 值 Value
97 年 度 FY2008	1,048,370	166,570,266	698,391,251
98 年 度 FY2009	1,066,524	171,184,561	715,945,585
99 年 度 FY2010	1,080,152	176,383,620	741,065,141
100 年 度 FY2011	1,089,541	178,554,255	753,492,124
101 年 度 FY2012	1,097,581	180,692,750	832,912,306
住 家 用 Residence	770,974	82,416,306	324,691,785
營 業 用 Business	140,211	31,219,000	224,972,500
非住家非營業用 Non-Residence、Non-Business	51,193	15,208,375	93,091,912
全部免稅及部份免稅 Exempt House	135,203	51,849,069	190,156,110
鋼 骨 混 凝 土 造 Steeled Concrete	29,470	19,851,019	214,256,340
住 家 用 Residence	14,059	2,238,069	39,199,244
營 業 用 Business	8,057	6,791,691	90,251,924
非住家非營業用 Non-Residence、Non-Business	5,494	3,767,354	35,821,191
全部免稅及部份免稅 Exempt House	1,860	7,053,906	48,983,982
鋼 筋 混 凝 土 及 預 鑄 造 Concrete&Reinforced Prefabricated	922,605	143,354,487	596,965,563
住 家 用 Residence	699,681	71,913,133	274,431,544
營 業 用 Business	110,742	21,422,669	130,478,678
非住家非營業用 Non-Residence、Non-Business	43,437	11,004,923	56,668,016
全部免稅及部份免稅 Exempt House	68,745	39,013,762	135,387,325
鋼 筋 混 凝 土 加 強 磚 造 Ferroconcrete Brick	101,560	12,929,627	17,338,414
住 家 用 Residence	50,294	7,102,822	9,669,140
營 業 用 Business	14,367	2,071,361	3,185,749
非住家非營業用 Non-Residence、Non-Business	1,590	304,939	453,072
全部免稅及部份免稅 Exempt House	35,309	3,450,505	4,030,454
鋼 鐵 造 Metal	6,188	1,370,921	1,758,736
住 家 用 Residence	2,496	410,233	557,799
營 業 用 Business	1,812	529,040	683,099
非住家非營業用 Non-Residence、Non-Business	259	76,528	96,481
全部免稅及部份免稅 Exempt House	1,621	355,120	421,357

資料來源：根據本處財產稅科資料編製。

Table 8. Sources of House Tax

 Unit { Area : m²
 Amount : N.T.\$1,000

公有 Public			私有 Private		
戶數 Number of House	面積 Area	現值 Value	戶數 Number of House	面積 Area	現值 Value
22,165	19,411,230	76,405,201	1,026,205	147,159,036	621,986,050
25,199	21,669,145	85,409,345	1,041,325	149,515,416	630,536,240
26,422	24,158,745	92,550,508	1,053,730	152,224,875	648,514,633
25,223	23,243,844	92,350,866	1,064,318	155,310,411	661,141,259
25,604	23,768,422	101,179,846	1,071,977	156,924,328	731,732,460
5,708	618,278	3,386,341	765,266	81,798,029	321,305,444
1,155	1,336,608	8,752,212	139,056	29,882,392	216,220,288
575	1,424,275	4,622,549	50,618	13,784,100	88,469,363
18,166	20,389,262	84,418,744	117,037	31,459,808	105,737,365
652	4,055,215	32,006,405	28,818	15,795,804	182,249,935
108	32,442	512,260	13,951	2,205,628	38,686,984
144	405,671	3,665,606	7,913	6,386,020	86,586,318
65	287,837	1,345,270	5,429	3,479,517	34,475,921
335	3,329,266	26,483,270	1,525	3,724,640	22,500,712
17,463	18,361,458	67,539,522	905,142	124,993,030	529,426,041
5,523	574,271	2,857,745	694,158	71,338,863	271,573,799
825	888,179	5,024,438	109,917	20,534,490	125,454,240
482	1,128,541	3,268,154	42,955	9,876,382	53,399,862
10,633	15,770,468	56,389,185	58,112	23,243,295	78,998,140
2,310	697,598	1,003,177	99,250	12,232,029	16,335,237
53	8,340	12,480	50,241	7,094,483	9,656,659
90	29,310	48,645	14,277	2,042,052	3,137,104
20	5,346	6,526	1,570	299,593	446,546
2,147	654,603	935,526	33,162	2,795,902	3,094,928
164	129,707	210,847	6,024	1,241,214	1,547,889
2	239	334	2,494	409,994	557,464
14	2,943	2,457	1,798	526,097	680,642
1	630	852	258	75,898	95,629
147	125,895	207,204	1,474	229,225	214,154

表 8 房 屋 稅 稅 源 (續)

單位 { 面積：平方公尺
金額：新臺幣千元

年度別、構造及使用別 Fiscal Year & Structure & Use	合計 Total		
	戶數 Number of House	面積 Area	現值 Value
磚 石 造 Brick	26,487	2,435,987	2,155,850
住家用 Residence	4,153	697,502	779,393
營業用 Business	3,883	311,438	296,562
非住家非營業用 Non-Residence · Non-Business	322	45,629	47,288
全部免稅及部份免稅 Exempt House	18,129	1,381,417	1,032,607
砧 砧 石 造 Lo-Ko Stone	388	26,784	16,178
住家用 Residence	10	2,311	1,967
營業用 Business	75	2,821	2,051
非住家非營業用 Non-Residence · Non-Business	9	970	603
全部免稅及部份免稅 Exempt House	294	20,682	11,558
卵 石 混 凝 土 造 Concrete & Pebble	39	4,072	3,354
住家用 Residence	9	1,586	1,575
營業用 Business	1	200	97
非住家非營業用 Non-Residence · Non-Business	4	237	205
全部免稅及部份免稅 Exempt House	25	2,049	1,478
木 造 Wood	9,398	614,937	411,105
住家用 Residence	268	49,284	50,049
營業用 Business	1,255	85,000	73,599
非住家非營業用 Non-Residence · Non-Business	78	7,764	4,877
全部免稅及部份免稅 Exempt House	7,797	472,888	282,579
土 磚 造 Earthen Brick	1,238	93,416	4,656
住家用 Residence	2	328	249
營業用 Business	8	1,256	84
非住家非營業用 Non-Residence · Non-Business	—	—	—
全部免稅及部份免稅 Exempt House	1,228	91,832	4,322
竹 造 Bamboo	208	11,501	2,112
住家用 Residence	2	1,037	826
營業用 Business	11	3,524	657
非住家非營業用 Non-Residence · Non-Business	—	31	180
全部免稅及部份免稅 Exempt House	195	6,909	449

Table 8. Sources of House Tax (Cont.)

 Unit { Area : m²
 Amount : N.T.\$1,000

公有 Public			私有 Private		
戶數 Number of House	面積 Area	現值 Value	戶數 Number of House	面積 Area	現值 Value
2,351	310,186	285,611	24,136	2,125,801	1,870,239
15	1,714	2,158	4,138	695,788	777,235
48	8,168	9,590	3,835	303,271	286,972
6	1,893	1,731	316	43,737	45,556
2,282	298,411	272,132	15,847	1,083,006	760,475
24	1,328	811	364	25,456	15,368
—	—	—	10	2,311	1,967
—	—	—	75	2,821	2,051
—	—	—	9	970	603
24	1,328	811	270	19,354	10,747
1	136	58	38	3,936	3,297
—	—	—	9	1,586	1,575
—	—	—	1	200	97
—	—	—	4	237	205
1	136	58	24	1,913	1,421
2,620	211,964	133,388	6,778	402,973	277,717
7	1,273	1,363	261	48,012	48,686
34	2,338	1,476	1,221	82,662	72,124
1	29	17	77	7,735	4,860
2,578	208,324	130,532	5,219	264,564	152,047
14	595	19	1,224	92,821	4,636
—	—	—	2	328	249
—	—	—	8	1,256	84
—	—	—	—	—	—
14	595	19	1,214	91,237	4,303
5	235	9	203	11,266	2,103
—	—	—	2	1,037	826
—	—	—	11	3,524	657
—	—	—	—	31	180
5	235	9	190	6,674	439

表 9 使用牌照稅稅源 ①

單位：件數

年 度 (月) 別 Fiscal Year (Month)			合 計 Grand Total		小客車② Sedan	
			應 稅 Taxable	免 稅 Exempt	應 稅 Taxable	免 稅 Exempt
92	年 度	FY2003	745,295	13,223	668,657	12,167
93	年 度	FY2004	778,892	13,965	696,942	12,605
94	年 度	FY2005	808,646	12,591	720,200	11,999
95	年 度	FY2006	735,342	17,237	642,890	16,577
96	年 度	FY2007	742,355	16,855	650,569	16,391
97	年 度	FY2008	746,054	16,177	644,206	15,696
98	年 度	FY2009	740,831	17,330	638,594	16,937
99	年 度	FY2010	760,699	17,301	654,886	16,779
100	年 度	FY2011	785,192	14,007	675,588	13,311
101	年 度	FY2012	807,716	17,117	693,474	16,256
1	月	Jan.	13,275	1,264	11,917	1,247
2	月	Feb.	12,415	1,294	10,503	1,236
3	月	Mar.	37,361	1,905	32,279	1,858
4	月	Apr.	320,132	1,832	280,513	1,795
5	月	May	275,252	1,568	240,865	1,537
6	月	June	10,470	1,506	9,210	1,438
7	月	July	14,155	1,723	12,345	1,572
8	月	Aug.	12,441	1,247	10,470	1,171
9	月	Sep.	6,904	1,115	5,338	987
10	月	Oct.	26,758	1,246	18,269	1,174
11	月	Nov.	71,171	1,243	55,646	1,139
12	月	Dec.	7,382	1,174	6,119	1,102

資料來源：根據本處機會稅科資料編製。

附 註：①本表臨時牌照、試車牌照及外賓車輛不予計列。

②小客車、大客車、貨車中均分為自用與營業用，自用全年開徵1次。營業用分兩期開徵，表列數字均依照年度結束累計數填列。

Table 9. Sources of Vehicle License Tax ①

Unit : Case

大客車② Bus		貨車② Truck		機器腳踏車③ Motorcycle	
應 稅 Taxable	免 稅 Exempt	應 稅 Taxable	免 稅 Exempt	應 稅 Taxable	免 稅 Exempt
6,265	330	67,907	698	2,466	28
6,533	1,073	71,653	252	3,764	35
6,424	299	77,151	285	4,871	8
6,418	398	80,153	246	5,881	16
6,639	216	84,277	241	870	7
6,582	257	87,197	220	8,069	4
6,682	213	86,878	168	8,677	12
7,535	318	88,809	171	9,469	33
7,961	520	90,583	154	11,060	22
8,237	643	92,732	197	13,273	21
95	10	1,014	7	249	—
118	40	1,455	18	339	—
203	41	3,648	6	1,231	—
1,899	29	31,912	5	5,808	3
1,761	19	29,266	11	3,360	1
115	56	885	12	260	—
192	133	1,170	18	448	—
203	72	1,367	3	401	1
189	89	1,067	39	310	—
1,917	57	6,233	13	339	2
1,373	56	13,867	46	285	2
172	41	848	19	243	12

表 10 契 稅 稅 源

金額單位：新臺幣千元

年 度 (月) 別 Fiscal Year (Month)			合 計 Total		買 賣 契 Sale		典 權 契 Mortgage	
			件 數 Cases	契 價 Deed Value	件 數 Cases	契 價 Deed Value	件 數 Cases	契 價 Deed Value
92	年 度	FY2003	68,131	35,672,708	59,655	32,068,188	—	—
93	年 度	FY2004	74,604	41,478,262	66,304	37,216,205	6	1,930
94	年 度	FY2005	78,805	42,521,645	70,956	39,447,405	2	183
95	年 度	FY2006	79,012	41,555,453	71,997	38,820,971	—	—
96	年 度	FY2007	73,683	41,980,833	65,634	38,907,839	—	—
97	年 度	FY2008	75,310	41,816,490	67,242	38,369,514	—	—
98	年 度	FY2009	74,931	41,053,558	66,802	38,260,775	1	486
99	年 度	FY2010	75,298	40,464,169	66,392	37,287,407	1	0
100	年 度	FY2011	61,336	35,197,097	51,816	31,575,261	1	133
101	年 度	FY2012	51,933	31,062,867	41,217	27,193,643	—	—
1	月	Jan.	5,227	2,783,784	3,285	2,160,857	—	—
2	月	Feb.	3,288	2,047,597	2,275	1,663,887	—	—
3	月	Mar.	3,340	1,988,470	2,649	1,557,048	—	—
4	月	Apr.	4,170	2,366,444	3,430	2,126,881	—	—
5	月	May	4,632	1,491,765	3,891	1,336,720	—	—
6	月	June	4,925	2,420,901	4,037	2,242,070	—	—
7	月	July	4,751	2,652,905	3,973	2,297,358	—	—
8	月	Aug.	4,571	3,454,421	3,864	3,128,673	—	—
9	月	Sep.	3,724	2,546,163	3,087	2,326,626	—	—
10	月	Oct.	3,854	2,967,735	3,140	2,655,454	—	—
11	月	Nov.	4,899	3,543,741	4,056	3,206,568	—	—
12	月	Dec.	4,552	2,798,941	3,530	2,491,501	—	—

資料來源：根據本處財產稅科資料編製。

附 註：本表件數含應稅與免稅。

Table 10. Sources of Deed Tax

Unit : N.T.\$1,000

交換契 Exchange		贈與契 Donation		分割契 Division		占有契 Staking	
件數 Cases	契價 Deed Value	件數 Cases	契價 Deed Value	件數 Cases	契價 Deed Value	件數 Cases	契價 Deed Value
913	990,596	7,318	2,214,595	245	399,329	—	—
891	1,281,176	7,054	2,265,958	348	712,349	1	644
938	927,672	6,672	1,891,870	236	254,221	1	294
926	1,019,933	5,912	1,519,979	173	193,656	4	914
1,348	1,345,151	6,613	1,688,921	88	38,922	—	—
1,308	1,306,651	6,590	1,721,469	170	418,856	—	—
1,013	911,399	7,015	1,854,852	100	26,046	—	—
894	815,303	7,914	2,207,685	97	153,774	—	—
1,117	1,120,083	8,350	2,490,558	52	11,062	—	—
1,178	1,079,514	9,474	2,771,281	64	18,429	—	—
43	37,643	1,896	584,033	3	1,251	—	—
103	129,357	901	252,135	9	2,218	—	—
103	235,744	582	194,658	6	1,020	—	—
86	43,711	650	195,589	4	263	—	—
45	37,779	684	111,883	12	5,383	—	—
180	-38,576	702	215,892	6	1,515	—	—
190	187,387	586	168,067	2	93	—	—
108	118,306	584	204,984	15	2,458	—	—
77	65,550	560	153,987	—	—	—	—
67	134,615	644	173,554	3	4,112	—	—
83	59,427	758	277,688	2	58	—	—
93	68,571	927	238,811	2	58	—	—

表 11 印花稅稅源

單位：新臺幣千元

年 度 (月) 別 Fiscal Year (Month)	合 計① Total	出 售 印 花 稅 票 Taxes Stamps	總		
			金融業 Finance	保 險 業 Insurance	傳 播 業 Broadcasting
97 年 度 FY2008	4,555,750	755,125	1,398,692	896,879	2,451
98 年 度 FY2009	3,890,354	568,107	1,093,360	634,146	2,067
99 年 度 FY2010	4,061,562	565,080	1,138,041	575,952	2,035
100 年 度 FY2011	4,232,189	514,547	1,175,596	616,064	1,978
101 年 度 FY2012	4,466,450	477,820	1,182,223	684,628	1,926
1 月 Jan.	699,771	45,191	211,715	107,484	320
2 月 Feb.	76,007	28,945	—	—	—
3 月 Mar.	563,437	26,847	190,083	120,916	286
4 月 Apr.	101,018	33,189	—	—	—
5 月 May	583,262	28,720	196,385	108,287	320
6 月 June	93,328	38,250	—	—	—
7 月 July	649,170	50,394	188,491	118,115	382
8 月 Aug.	137,555	66,829	—	—	—
9 月 Sep.	697,285	62,698	198,700	124,680	324
10 月 Oct.	107,046	34,490	—	—	—
11 月 Nov.	633,597	30,983	196,850	105,146	294
12 月 Dec.	124,974	31,282	—	—	—

資料來源：根據本處機會稅科資料編製。

附 註：①指本年度實徵數。

Table 11. Sources of Stamp Tax

Unit : N.T.\$1,000

繳				Total Payment	違章補繳 Payment on Tax Evasion
公用事業 Utilities	承攬契據 Construction agreements	財產契據 Real Estate Deed	其他 Others		
14,085	451,229	265,633	771,592	65	
19,497	384,248	279,449	909,358	122	
22,504	391,806	330,777	1,035,364	3	
23,682	500,736	315,310	1,084,271	5	
23,304	629,040	283,867	1,183,611	31	
4,711	72,628	8,822	248,900	0	
—	24,728	20,685	1,649	—	
3,805	32,079	20,120	169,301	—	
—	36,277	21,827	9,725	—	
4,007	41,158	26,556	177,828	—	
—	28,372	25,373	1,332	—	
3,437	71,959	28,438	187,951	4	
—	49,844	19,486	1,396	—	
3,997	100,655	19,702	186,501	27	
—	39,905	23,636	9,015	0	
3,346	82,893	31,086	183,000	—	
0	48,543	38,136	7,012	—	

表 12 娛 樂 稅 稅 源 ①

金額單位：新臺幣元

年 度 (月) 別 Fiscal Year (Month)			合 計 Total		電 影 Movies	
			家 數 Unit	實 徵 稅 額 Net Amount Remitted	家 數 Unit	實 徵 稅 額 Net Amount Remitted
92	年 度	FY2003	2,020	187,440,041	45	33,571,341
93	年 度	FY2004	1,972	220,654,104	52	42,363,492
94	年 度	FY2005	2,308	242,087,524	44	47,458,117
95	年 度	FY2006	2,037	243,999,753	40	48,012,314
96	年 度	FY2007	1,859	197,243,270	38	46,686,982
97	年 度	FY2008	1,781	212,488,992	37	39,388,243
98	年 度	FY2009	1,718	210,022,962	33	42,732,259
99	年 度	FY2010	1,671	226,872,556	36	52,681,026
100	年 度	FY2011	1,677	243,807,447	36	60,653,547
101	年 度	FY2012	1,624	224,137,868	37	57,768,614
1	月	Jan.	1,682	18,834,590	36	5,056,910
2	月	Feb.	1,646	20,758,271	36	5,022,313
3	月	Mar.	1,636	20,359,073	36	4,047,134
4	月	Apr.	1,646	16,417,919	36	3,631,712
5	月	May	1,630	21,016,274	37	5,642,700
6	月	June	1,636	20,729,082	37	5,043,173
7	月	July	1,619	16,710,813	37	4,482,591
8	月	Aug.	1,614	19,299,046	37	7,541,999
9	月	Sep.	1,626	19,457,728	37	5,978,049
10	月	Oct.	1,670	18,372,601	35	3,580,245
11	月	Nov.	1,685	16,913,797	36	3,360,785
12	月	Dec.	1,624	15,268,674	37	4,381,003

資料來源：根據本處機會稅科資料編製。

附 註：①93年以前家數為實徵家數，實徵稅額為本年度實徵數；94年起家數為自動報繳及查定之家數，實徵稅額為實徵淨額。

②其他欄內包括臨時公演及夜總會、戲劇等。

表 12 娛 樂 稅 稅 源 ① (續)

金額單位：新臺幣元

年 度 (月) 別 Fiscal Year (Month)			高爾夫球練習場 Golf		舞廳 (場) Dance Halls		電子遊戲機 Electric Toys	
			家數 Unit	實徵稅額 Net Amount Remitted	家數 Unit	實徵稅額 Net Amount Remitted	家數 Unit	實徵稅額 Net Amount Remitted
92	年 度	FY2003	12	2,280,719	39	21,992,724	360	21,151,944
93	年 度	FY2004	13	4,930,744	43	22,843,408	362	21,320,140
94	年 度	FY2005	13	5,310,997	46	24,977,469	138	22,193,156
95	年 度	FY2006	13	3,846,895	42	22,974,644	111	9,239,571
96	年 度	FY2007	13	2,407,224	32	17,620,681	86	8,960,627
97	年 度	FY2008	14	-6,539,283	32	15,664,322	78	8,313,668
98	年 度	FY2009	14	3,003,059	27	13,659,294	78	6,683,071
99	年 度	FY2010	14	3,092,520	28	12,137,962	70	6,257,564
100	年 度	FY2011	14	3,510,075	26	10,112,917	68	5,801,330
101	年 度	FY2012	16	3,424,660	21	9,148,763	65	5,721,201
1	月	Jan.	14	333,318	26	979,464	66	467,360
2	月	Feb.	14	266,612	27	804,479	67	510,498
3	月	Mar.	14	252,881	26	759,674	66	484,963
4	月	Apr.	14	277,887	25	753,594	64	484,429
5	月	May	14	322,751	24	762,885	63	486,000
6	月	June	14	243,646	24	770,859	66	452,728
7	月	July	14	298,090	24	717,136	64	463,106
8	月	Aug.	15	284,419	23	735,329	64	492,265
9	月	Sep.	15	239,012	24	725,117	63	489,768
10	月	Oct.	15	278,901	22	691,346	65	482,618
11	月	Nov.	16	317,606	21	724,936	65	476,591
12	月	Dec.	16	309,537	21	723,944	65	430,875

Table 12. Sources of Amusement Tax ① (Cont.)

Unit : N.T.\$1

有節目餐飲業 Entertainment Restaurants		MTV等視聽業 MTV Audiovisual Services		其他② Others	
家數 Unit	實徵稅額 Net Amount Remitted	家數 Unit	實徵稅額 Net Amount Remitted	家數 Unit	實徵稅額 Net Amount Remitted
33	5,061,280	1,255	77,335,200	152	22,011,805
35	2,920,937	1,173	99,985,972	188	23,692,076
43	3,328,523	1,376	108,439,846	545	26,072,117
41	5,183,399	1,330	103,915,313	369	46,955,592
37	5,440,419	1,262	77,130,597	387	37,001,453
29	5,442,995	1,243	93,469,130	347	56,552,132
31	3,977,099	1,184	77,448,808	350	62,397,510
37	3,747,894	1,143	76,850,740	342	71,990,208
36	4,246,597	1,158	77,062,565	338	82,286,593
37	4,329,054	1,102	73,187,045	345	70,486,111
36	366,825	1,161	6,499,713	342	5,131,000
36	298,763	1,149	7,728,745	316	6,114,791
35	444,207	1,147	6,702,516	311	7,661,663
35	522,788	1,143	5,763,658	328	4,977,816
35	339,467	1,136	6,263,770	320	7,192,666
35	399,563	1,130	5,561,935	329	8,251,143
35	460,111	1,124	5,961,658	320	4,322,086
35	321,952	1,114	5,740,434	325	4,176,613
34	279,192	1,115	6,177,769	337	5,562,786
37	347,661	1,104	6,118,732	391	6,867,063
36	291,705	1,100	5,748,836	410	5,987,303
37	256,820	1,102	4,919,279	345	4,241,181

表 13 違章漏稅案件處理及財務罰鍰執行情形表

單位 { 件數：件
金額：新臺幣千元

年度及稅目別 Fiscal Year & Item of Tax	受理情形 No. of Cases Accepted			本期審理情形	
	合計 Total	上期未 結件數 Unclosed Cases of Last Term	本期受 理件數 Cases Accepted in this Term	依法免 議件數 Cases Not Indictable	依法免 罰件數 Fine Free Cases
92 年 度 FY2003	2,646	4	2,642	15	75
93 年 度 FY2004	2,921	8	2,913	18	122
94 年 度 FY2005	5,082	347	4,735	68	100
95 年 度 FY2006	3,909	61	3,848	80	105
96 年 度 FY2007	5,408	232	5,176	199	73
97 年 度 FY2008	6,799	143	6,656	368	36
98 年 度 FY2009	7,725	37	7,688	398	186
99 年 度 FY2010	14,445	147	14,298	576	2,976
100 年 度 FY2011	7,936	260	7,676	542	1,034
101 年 度 FY2012	6,042	72	5,970	382	726
地 價 稅 Land Value Tax	5	—	5	2	—
土 地 增 值 稅 Land Value Increment Tax	—	—	—	—	—
房 屋 稅 House Tax	3	—	3	2	—
使 用 牌 照 稅 Vehicle License Tax	6,010	69	5,941	374	724
契 稅 Deed Tax	—	—	—	—	—
印 花 稅 Stamp Tax	8	2	6	2	—
娛 樂 稅 Amusement Tax	16	1	15	2	2

資料來源：根據本處稅務管理科資料編製。

Table 13. The Management of Cases of Tax Evasion Against Law
and Execution Status of Fine

Unit: { Case
N.T.\$1,000

Cases Interrogated in This Term			本期繳納及移送情形 Cases of Find Paid and Transferred to Law Court in This Term					
處罰 Cases Fined		未結 件數 Cases Unclosed	合計 Total		自行繳納 Paid		移送執行 Transferred to Law Court	
件數 Cases	金額 Amount		件數 Cases	金額 Amount	件數 Cases	金額 Amount	件數 Cases	金額 Amount
2,548	91,764	8	2,810	63,901	2,563	47,894	247	16,007
2,434	55,723	347	3,024	90,848	2,752	75,900	272	14,948
4,853	98,832	61	3,342	82,690	3,303	78,801	39	3,889
3,492	59,977	232	3,867	82,339	3,053	53,577	814	28,762
4,993	110,999	143	5,351	93,588	3,070	36,461	2,281	57,127
6,358	187,241	37	6,649	141,108	3,567	56,162	3,082	84,946
6,994	142,501	147	9,527	177,289	2,991	56,029	6,536	121,260
10,633	230,263	260	13,542	253,119	4,703	42,138	8,839	210,981
6,288	101,053	72	13,282	213,703	4,897	31,559	8,385	182,144
4,890	81,560	44	11,727	178,053	4,092	23,740	7,635	154,313
3	3,863	—	1	29	1	29	—	—
—	—	—	2	—	2	—	—	—
1	101	—	—	—	—	—	—	—
4,869	75,272	43	11,697	177,549	4,066	23,408	7,631	154,141
—	—	—	—	—	—	—	—	—
6	2,258	—	10	263	7	240	3	23
11	66	1	17	212	16	63	1	149

表 13 違章漏稅案件處理及財務罰鍰執行情形表 (續)

單位 { 件數：件
金額：新臺幣千元

年度及稅目別 Fiscal Year & Item of Tax	更正註銷案件 Case of Revising or Cancelling		截至本期末繳未移送 Cases of Not Transferred of Fined		本 期	
	合計 Total					
	件 數 Cases	金 額 Amount	件 數 Cases	金 額 Amount	件 數 Cases	金 額 Amount
92 年 度 FY2003	- 285	-458	3,473	956,196	121	5,030
93 年 度 FY2004	- 318	24,577	3,288	898,675	182	5,898
94 年 度 FY2005	- 295	15,072	5,208	903,209	186	8,609
95 年 度 FY2006	- 224	26,333	5,239	859,127	329	11,284
96 年 度 FY2007	- 305	10,162	5,904	886,003	1,106	31,902
97 年 度 FY2008	- 908	30,551	8,284	943,501	2,576	59,340
98 年 度 FY2009	-1,399	24,282	10,086	977,070	4,341	118,649
99 年 度 FY2010	-1,745	15,011	13,650	1,056,004	6,478	148,069
100 年 度 FY2011	-1,890	38,177	11,325	265,486	9,270	219,195
101 年 度 FY2012	-3,553	1,865	12,785	284,823	6,560	150,690
地 價 稅 Land Value Tax	2	3,834	—	—	—	—
土 地 增 值 稅 Land Value Increment Tax	- 2	5,247	1	10,920	—	5,247
房 屋 稅 House Tax	1	101	—	—	—	—
使 用 牌 照 稅 Vehicle License Tax	-3,558	-11,011	12,778	270,995	6,550	143,851
契 稅 Deed Tax	—	—	—	—	—	—
印 花 稅 Stamp Tax	6	2,891	3	2,559	5	446
娛 樂 稅 Amusement Tax	- 2	803	3	349	5	1,146

Table 13. The Management of Cases of Tax Evasion Against Law and Execution Status of Fine (Cont.)

Unit: { Case
N.T.\$1,000

執行情形 Cases Executed in This Term						截至本期未執行案件 Cases Unexecuted	
移送繳納 Fined Paid		發給執行憑證 Giving Executive Evidence		移送駁回或撤回 Cases of Withdrawn or Rejected			
件數 Cases	金額 Amount	件數 Cases	金額 Amount	件數 Cases	金額 Amount	件數 Cases	金額 Amount
68	2,803	46	1,255	7	972	1,140	565,386
95	3,717	74	1,837	13	344	1,230	574,436
72	5,145	84	2,335	30	1,129	1,083	569,716
147	6,671	175	4,364	7	249	1,568	587,194
388	12,275	675	17,291	43	2,336	2,743	612,419
813	17,424	1,695	39,871	68	2,045	3,249	638,025
1,405	26,010	2,829	90,581	107	2,058	5,444	640,636
1,750	31,268	4,584	113,901	144	2,900	7,805	703,548
2,118	41,503	7,019	173,858	133	3,834	5,866	180,815
1,816	32,995	4,616	114,427	128	3,268	6,941	184,438
—	—	—	—	—	—	—	—
—	5,247	—	—	—	—	1	10,920
—	—	—	—	—	—	—	—
1,816	27,721	4,607	113,203	127	2,927	6,932	153,508
—	—	—	—	—	—	—	—
—	3	5	443	—	—	6	19,834
—	24	4	781	1	341	2	176

表 14 各項稅捐滯納案件移送執行情形

金額單位：新臺幣元

年度及稅目別 Fiscal Year & Item of Tax	移送執行數 ^① Executed cases		執行徵起數(1) Executive Levied Tax		掣發債權憑證數(2) Giving Executive Evidence	
	件數 Cases	金額 Amount	件數 Cases	金額 Amount	件數 Cases	金額 Amount
92 年度 FY2003	82,975	2,528,705,120	33,980	678,770,421	12,313	105,138,623
93 年度 FY2004	79,553	1,393,535,195	36,486	756,379,529	16,963	147,329,015
94 年度 FY2005	51,283	1,595,546,632	32,601	588,246,111	23,519	167,858,366
95 年度 FY2006	81,754	1,671,258,452	44,204	1,082,993,724	36,292	240,778,668
96 年度 FY2007	82,875	1,058,039,055	46,559	827,587,893	61,579	497,154,171
97 年度 FY2008	76,381	1,024,567,477	39,497	611,348,255	50,078	439,371,016
98 年度 FY2009	86,642	1,070,882,804	38,327	667,009,679	51,666	481,404,542
99 年度 FY2010	80,769	842,479,642	35,215	573,963,337	54,967	843,341,510
100 年度 FY2011	59,383	727,698,688	32,371	714,712,214	53,687	823,659,132
101 年度 FY2012	55,501	546,330,038	26,548	438,195,809	25,761	262,966,626
地 價 稅 Land Value Tax	14,417	169,905,426	8,353	199,232,716	5,634	70,886,652
土 地 增 值 稅 Land Value Increment Tax	5	5,688,360	2	659,052	10	17,526,183
房 屋 稅 House Tax	7,214	61,877,954	6,172	87,827,142	2,595	27,473,709
使 用 牌 照 稅 Vehicle License Tax	31,500	226,507,912	11,602	96,588,695	16,071	107,423,253
契 稅 Deed Tax	27	679,638	9	221,252	15	531,471
印 花 稅 Stamp Tax	2	6,859	1	5,521	3	105,592
娛 樂 稅 Amusement Tax	2,336	6,170,975	409	1,092,165	1,433	4,479,154
罰 鍰 ^③ Punitive Fine Revenue	—	75,492,914	—	52,569,266	—	34,540,612

資料來源：根據本處稅務管理科資料編製。

附 註：①包括以前年度移送未執行結轉數。

②罰鍰係指本稅以外之短估金、滯(息)報金、滯納金及加計利息等之合計數，故不計件數。

Table 14. The Status of Delayed Case Transferred to Execution

Unit : N.T.\$1

撤 退 案 數 (3)		稅 捐 處 結 案 數 (1+2+3=4)		移 送 尚 未 執 行 數	
Cases of Withdrawn		Closed Cases		Unexecuted Cases	
件 數 Cases	金 額 Amount	件 數 Cases	金 額 Amount	件 數 Cases	金 額 Amount
1,465	125,097,684	47,758	909,006,728	153,711	4,260,705,299
2,145	97,238,093	55,594	1,000,946,637	171,224	3,701,233,044
4,248	282,299,009	60,368	1,038,403,486	151,141	3,993,496,359
4,074	176,829,888	84,570	1,500,602,280	144,239	3,996,599,528
3,946	101,388,745	112,084	1,426,130,809	111,010	3,564,275,012
2,338	104,810,618	91,913	1,155,529,889	92,189	3,380,106,899
1,977	35,843,492	91,970	1,184,257,713	83,718	3,209,836,714
1,851	24,838,280	92,033	1,442,143,127	70,335	2,560,047,010
933	15,260,562	86,991	1,553,631,908	41,370	1,603,167,185
1,017	14,761,965	53,326	715,924,400	42,845	1,395,183,086
366	7,973,594	14,353	278,092,962	9,938	460,307,675
3	618,179	15	18,803,414	23	367,267,946
228	1,248,557	8,995	116,549,408	6,202	159,144,267
405	3,138,127	28,078	207,150,075	25,131	178,361,233
—	—	24	752,723	14	566,751
—	—	4	111,113	2	214,652
15	43,936	1,857	5,615,255	1,535	4,445,588
—	1,739,572	—	88,849,450	—	224,874,974

表 15 查(核)定開徵數及未徵數情形

單位 { 件數：件
金額：新臺幣千元

一. 本年度

年度及稅目別 Fiscal Year & Item of Tax	查(核)定開徵數 Opening Collection for Assessed(Verified) (1)		實徵數 Tax Collected (2)		減免註銷數 Cancelled (3)		逾徵收 期限數 Overdue (4)	
	件數 Cases	金額 Amount	件數 Cases	金額 Amount	件數 Cases	金額 Amount	件數 Cases	金額 Amount
	97 年度 FY2008	2,903,841	58,916,092	2,800,117	54,454,995	21,525	2,264,995	—
98 年度 FY2009	2,937,340	57,788,816	2,832,920	54,984,201	24,194	1,145,170	—	—
99 年度 FY2010	3,025,499	62,977,206	2,903,255	59,320,680	44,195	1,964,206	1	2
100 年度 FY2011	3,008,150	63,464,263	2,912,650	59,970,637	29,434	2,144,176	—	—
101 年度 FY2012	3,041,661	64,291,613	2,950,791	60,881,995	23,796	1,568,405	—	—
地價稅 Land Value Tax	902,794	21,586,129	864,936	20,243,111	2,631	296,644	—	—
土地增值稅 Land Value Increment Tax	71,209	17,363,896	68,293	16,137,849	1,803	727,124	—	—
房屋稅 House Tax	1,023,817	12,099,495	1,014,529	11,765,751	1,788	246,016	—	—
使用牌照稅 Vehicle License Tax	865,531	7,059,609	836,982	6,735,234	13,798	236,808	—	—
契稅 Deed Tax	53,119	1,833,740	51,447	1,767,833	1,061	44,565	—	—
印花稅 Stamp Tax	99,146	4,035,031	93,498	3,988,630	2,014	8,072	—	—
娛樂稅 Amusement Tax	20,616	229,634	19,256	222,584	309	1,599	—	—
罰鍰 Fine	5,429	84,079	1,850	21,004	392	7,578	—	—

資料來源：根據本處稅務管理科資料編製。

附註：1.本表以開徵始日為統計基礎。

2.實徵數之件數及金額未包含實徵當查定部分。

Table 15. The Management of Opening Collection for Assessed (Verified) and of Tax Not Collected

Unit: { Case
N.T.\$1,000

1. Current Year

逾核課期限數 Excess Assessment (5)		未徵數餘額 Balance of Tax Not Collected					
		合計 Total (6)=(1)-(2)-(3)-(4)-(5)		繳款書未送達 未徵數 Have Not Been Served the Payment Notice		未逾限繳日 未徵數 Have Not Exceeded the Deadline of Payment	
件數 Cases	金額 Amount	件數 Cases	金額 Amount	件數 Cases	金額 Amount	件數 Cases	金額 Amount
58	304	82,141	2,195,798	37,239	1,115,111	17,630	563,775
18	506	80,208	1,658,939	31,549	549,377	24,395	694,328
100	839	77,948	1,691,479	31,294	606,350	21,096	615,821
14	55	66,052	1,349,395	28,618	487,570	16,925	501,801
15	49	67,059	1,841,163	29,703	881,553	19,519	561,446
6	16	35,221	1,046,358	27,319	728,852	6,008	147,554
—	—	1,113	498,923	436	134,938	673	314,507
4	8	7,496	87,720	920	3,184	3,005	19,030
5	25	14,746	87,542	627	2,059	4,519	13,597
—	—	611	21,343	71	1,232	535	20,008
—	—	3,634	38,329	114	8,543	3,520	29,787
—	—	1,051	5,451	183	2,334	205	1,214
—	—	3,187	55,497	33	411	1,054	15,748

表 15 查(核)定開徵數及未徵數情形 (續1)

單位 { 件數：件
金額：新臺幣千元

一.本年度

年度及稅目別 Fiscal Year & Item of Tax	未徵數餘額							
	行政救濟 未徵數 Administrative Remedies		分期繳納 未徵數 Pay by Stages		特殊原因 未徵數 Special Reason		欠	
							小計	
	件數 Cases	金額 Amount	件數 Cases	金額 Amount	件數 Cases	金額 Amount	件數 Cases	金額 Amount
97 年度 FY2008	96	78,543	—	—	190	82	26,986	438,288
98 年度 FY2009	177	47,956	1	228	162	130	23,924	366,921
99 年度 FY2010	385	100,132	—	—	943	191	24,230	368,986
100 年度 FY2011	138	28,466	—	—	462	81	19,909	331,478
101 年度 FY2012	199	154,138	—	—	187	97	17,451	243,929
地 價 稅 Land Value Tax	168	60,604	—	—	15	2	1,711	109,345
土 地 增 值 稅 Land Value Increment Tax	1	48,894	—	—	—	—	3	583
房 屋 稅 House Tax	21	44,388	—	—	80	17	3,470	21,101
使 用 牌 照 稅 Vehicle License Tax	2	20	—	—	87	77	9,511	71,790
契 稅 Deed Tax	—	—	—	—	—	—	5	103
印 花 稅 Stamp Tax	—	—	—	—	—	—	—	—
娛 樂 稅 Amusement Tax	—	—	—	—	5	1	658	1,902
罰 鍰 Fine	7	233	—	—	—	—	2,093	39,105

Table 15. The Management of Opening Collection for Assessed (Verified) and of Tax Not Collected (Cont.1)

Unit: { Case
N.T.\$1,000

1. Current Year

Balance of Tax Not Collected							
稅 數				Pending Tax Arrears			
送達未逾滯納期 Service of Notice Has Not Exceeded Delinquency Period		移送執行未結 Transferred to Law Court Not Yet Closed		執行憑證數 Executive Evidence		其 他 Others	
件 數 Cases	金 額 Amount	件 數 Cases	金 額 Amount	件 數 Cases	金 額 Amount	件 數 Cases	金 額 Amount
5,736	56,020	11,990	191,763	756	6,721	8,504	183,784
2,392	115,391	14,874	153,142	760	7,473	5,898	90,915
3,381	30,033	14,261	170,109	2,144	24,500	4,444	144,343
2,379	38,893	11,643	108,743	1,897	16,956	3,990	166,886
2,896	26,988	10,106	93,600	824	7,616	3,625	115,725
473	7,980	806	6,732	—	—	432	94,634
2	68	1	515	—	—	—	—
325	1,392	1,302	10,780	16	100	1,827	8,830
1,569	11,055	6,414	49,862	418	2,157	1,110	8,715
—	—	5	103	—	—	—	—
—	—	—	—	—	—	—	—
76	326	425	1,029	105	461	52	86
451	6,167	1,153	24,579	285	4,898	204	3,461

表 15 查(核)定開徵數及未徵數情形 (續2)

單位 { 件數：件
金額：新臺幣千元

二. 以前年度

年度及稅目別 Fiscal Year & Item of Tax	查(核)定開徵數①		實徵數		減免註銷數		逾徵收 期限數	
	Opening Collection for Assessed(Verified) (1)		Tax Collected (2)		Cancelled (3)		Overdue (4)	
	件數 Cases	金額 Amount	件數 Cases	金額 Amount	件數 Cases	金額 Amount	件數 Cases	金額 Amount
97 年度 FY2008	282,756	6,254,583	105,130	2,013,664	3,036	203,823	19,823	181,193
98 年度 FY2009	247,442	5,940,217	93,329	2,228,577	3,983	72,532	16,641	205,543
99 年度 FY2010	235,711	4,934,146	98,006	1,424,320	1,372	227,162	19,741	406,871
100 年度 FY2011	220,787	4,341,814	93,336	1,752,666	6,370	113,053	17,745	388,801
101 年度 FY2012	184,058	3,393,966	76,631	1,306,722	1,214	61,911	17,482	204,789
地價稅 Land Value Tax	58,974	1,198,061	36,029	505,364	198	13,074	3,548	55,669
土地增值稅 Land Value Increment Tax	1,385	998,464	1,117	536,929	203	40,607	17	24,724
房屋稅 House Tax	19,821	326,276	10,132	103,794	186	2,159	2,032	31,556
使用牌照稅 Vehicle License Tax	77,615	444,098	21,636	86,944	144	1,742	9,824	64,917
契稅 Deed Tax	561	14,648	446	11,488	86	2,356	14	249
印花稅 Stamp Tax	2,582	21,249	2,488	24,441	87	-3,524	4	117
娛樂稅 Amusement Tax	5,687	15,916	725	2,032	57	14	1,108	3,578
罰鍰 Fine	17,433	375,254	4,058	35,731	253	5,482	935	23,980

附註：①係原開徵始日在上年度12月31日以前之查(核)定開徵稅款，未逾徵收期間而仍未徵起者。

Table 15. The Management of Opening Collection for Assessed (Verified) and of Tax Not Collected (Cont.2)

Unit: $\begin{cases} \text{Case} \\ \text{N.T.}\$1,000 \end{cases}$

逾核課期限數 Excess Assessment (5)		2. Previous Year 未徵數餘額 Balance of Tax Not Collected					
		合計 Total (6)=(1)-(2)-(3)-(4)-(5)		繳款書未送達 未徵數 Have Not Been Served the Payment Notice		未逾限繳日 未徵數 Have Not Exceeded the Deadline of Payment	
件數 Cases	金額 Amount	件數 Cases	金額 Amount	件數 Cases	金額 Amount	件數 Cases	金額 Amount
3,748	32,201	151,019	3,823,702	5,862	132,237	2,325	109,974
1,627	13,855	131,862	3,419,710	1,394	134,308	774	11,154
867	8,942	115,725	2,866,850	1,096	65,705	494	12,452
918	12,931	102,418	2,074,364	994	41,979	318	5,219
691	8,148	88,040	1,812,398	695	25,858	271	9,926
534	6,600	18,665	617,354	620	10,361	109	1,481
3	185	45	396,019	16	14,959	6	7,803
6	-5	7,465	188,773	4	1	120	314
143	1,101	45,868	289,394	38	356	33	293
—	—	15	556	—	—	—	—
—	—	3	215	—	—	—	—
—	—	3,797	10,294	10	12	2	6
5	267	12,182	309,794	7	169	1	28

表 15 查(核)定開徵數及未徵數情形 (續3完)

 單位 { 件數：件
 金額：新臺幣千元

二.以前年度

年度及稅目別 Fiscal Year & Item of Tax	未徵數餘額							
	行政救濟 未徵數 Administrative Remedies		分期繳納 未徵數 Pay by Stages		特殊原因 未徵數 Special Reason		欠 小計 Subtotal	
	件數 Cases	金額 Amount	件數 Cases	金額 Amount	件數 Cases	金額 Amount	件數 Cases	金額 Amount
	97 年度 FY2008	183	297,900	—	—	4,867	13,569	137,782
98 年度 FY2009	128	102,188	—	—	5,110	13,398	124,456	3,158,663
99 年度 FY2010	188	92,849	—	—	4,676	14,076	109,271	2,681,767
100 年度 FY2011	87	48,158	—	—	5,127	17,124	95,892	1,961,883
101 年度 FY2012	66	107,657	—	—	4,702	20,447	82,306	1,648,510
地 價 稅 Land Value Tax	36	74,659	—	—	1,916	18,670	15,984	512,184
土 地 增 值 稅 Land Value Increment Tax	—	—	—	—	—	—	23	373,257
房 屋 稅 House Tax	27	30,832	—	—	463	76	6,851	157,550
使 用 牌 照 稅 Vehicle License Tax	—	—	—	—	2,259	1,593	43,538	287,151
契 稅 Deed Tax	—	—	—	—	—	—	15	556
印 花 稅 Stamp Tax	—	—	—	—	1	0	2	215
娛 樂 稅 Amusement Tax	—	—	—	—	49	8	3,736	10,267
罰 鍰 Fine	3	2,166	—	—	14	100	12,157	307,330

Table 15. The Management of Opening Collection for Assessed (Verified) and of Tax Not Collected (Cont.3 End)

2. Previous Year

Unit: { Case
N.T.\$1,000

Balance of Tax Not Collected							
Pending Tax Arrears							
稅 數		移送執行未結		執行憑證數		其 他	
送達未逾滯納期 Service of Notice Has Not Exceeded Delinquency Period		Transferred to Law Court Not Yet Closed		Executive Evidence		Others	
件 數 Cases	金 額 Amount	件 數 Cases	金 額 Amount	件 數 Cases	金 額 Amount	件 數 Cases	金 額 Amount
2,353	16,786	58,782	2,566,613	73,980	635,686	2,667	50,938
281	4,569	45,484	2,424,849	77,847	707,279	844	21,966
146	1,392	31,026	1,889,076	77,567	769,787	532	21,512
115	881	20,254	1,219,373	75,114	723,418	409	18,210
65	361	14,602	1,001,966	67,306	635,422	333	10,761
57	347	5,475	411,632	10,248	96,715	204	3,489
—	—	21	366,730	1	22	1	6,504
2	3	3,520	136,782	3,273	20,391	56	374
4	7	3,935	29,520	39,557	257,460	42	165
—	—	2	359	13	197	—	—
—	—	2	215	—	—	—	—
2	4	216	840	3,514	9,415	4	9
—	—	1,431	55,889	10,700	251,221	26	220

表 16 各項稅捐現行稅率表（續 1）

稅別	稅級別	計 算 公 式
土 地 增 值 稅	第一級	應徵稅額＝土地漲價總數額〔超過原規定地價或前次移轉時申報現值（按臺灣地區消費者物價總指數調整後）未達百分之一百者〕×稅率（20%）。
	第二級	<p>應徵稅額＝土地漲價總數額【超過原規定地價或前次移轉時申報現值（按臺灣地區消費者物價總指數調整後）在百分之一百以上未達百分之二百者】×【稅率（30%）－〔（30%－20%）×減徵率〕】－累進差額（按臺灣地區消費者物價總指數調整後之原規定地價或前次移轉現值×A）。</p> <p>註：持有土地年限未超過 20 年者，無減徵，A 為 0.10。 持有土地年限超過 20 年以上者，減徵率為 20%，A 為 0.08。 持有土地年限超過 30 年以上者，減徵率為 30%，A 為 0.07。 持有土地年限超過 40 年以上者，減徵率為 40%，A 為 0.06。</p>
	第三級	<p>應徵稅額＝土地漲價總數額【超過原規定地價或前次移轉時申報現值（按臺灣地區消費者物價總指數調整後）在百分之二百以上者】×【稅率（40%）－〔（40%－20%）×減徵率〕】－累進差額（按臺灣地區消費者物價總指數調整後之原規定地價或前次移轉現值×B）。</p> <p>註：持有土地年限未超過 20 年者，無減徵，B 為 0.30。 持有土地年限超過 20 年以上者，減徵率為 20%，B 為 0.24。 持有土地年限超過 30 年以上者，減徵率為 30%，B 為 0.21。 持有土地年限超過 40 年以上者，減徵率為 40%，B 為 0.18。</p>
自用住宅用地稅率一律 10%		

表 16 各項稅捐現行稅率表 (續 3)

稅別	稅額 (元) 總排量 (立方公分)	車輛 種類	小客車		大客車	貨車	機器腳踏車
			自用	營業	全年	全年	全年
			全年	全年			
使 用 牌 照 稅	150 以下		—	—	—	—	0
	151~ 250		—	—	—	—	800
	251~ 500		1,620	900	—	900	1,620
	501~ 600		2,160	1,260	1,080	1,080	2,160
	601~ 1,200		4,320	2,160	1,800	1,800	4,320
	1,201~ 1,800		7,120	3,060	2,700	2,700	7,120
	1,801~ 2,400		11,230	6,480	3,600	3,600	11,230
	2,401~ 3,000		15,210	9,900	4,500	4,500	
	3,001~ 3,600	}	28,220	16,380	5,400	5,400	
	3,601~ 4,200				6,300	6,300	
	4,201~ 4,800	}	46,170	24,300	7,200	7,200	
	4,801~ 5,400				8,100	8,100	
	5,401~ 6,000	}	69,690	33,660	9,000	9,000	
	6,001~ 6,600				9,900	9,900	
	6,601~ 7,200	}	117,000	44,460	10,800	10,800	
	7,201~ 7,800				11,700	11,700	
	7,801~ 8,400	}	151,200	56,700	12,600	12,600	
8,401~ 9,000	13,500				13,500		
9,001~ 9,600	14,400				14,400		
9,601~ 10,200				15,300	15,300		
10,201 以上				16,200	16,200		

臨時牌照	
車別	每日稅額
小客車	41
大客車	23
貨車	22
曳引車	28
機器腳踏車	5

試車牌照	
車別	每日稅額
小客車	414
機器腳踏車	30

附註：1. 曳引車之稅額按貨車稅額加徵 30%。

2. 小客貨兩用車之稅額按自用小客車之稅額課徵。

3. 自用車全年 1 期，營業車全年分上、下 2 期課徵。

表 16 各項稅捐現行稅率表 (續 4)

稅別	車輛種類	稅額 (元)		用途	
		馬達最大馬力		自用	營業
		英制馬力(HP)	公制馬力(PS)		
使 用 牌	完全以電能為動力之電動小客車 (每車乘人座位 9 人以下者)	38 以下	38.6 以下	1,620	900
		38.1~ 56	38.7~ 56.8	2,160	1,260
		56.1~ 83	56.9~ 84.2	4,320	2,160
		83.1~182	84.3~184.7	7,120	3,060
		182.1~262	184.8~265.9	11,230	6,480
		262.1~322	266.0~326.8	15,210	9,900
		322.1~414	326.9~420.2	28,220	16,380
		414.1~469	420.3~476.0	46,170	24,300
		469.1~509	476.1~516.6	69,690	33,660
		509.1 以上	516.7 以上	117,000	44,460
照 稅	完全以電能為動力之電動機器腳踏車	12 以下	12.2 以下		0
		12.1-20	12.3-20.3		800
		20.1-45	20.4-45.7		1,620

附註：臺北市政府於 101 年 2 月 3 日公告，本市完全以電能為動力之電動汽車，自 101 年 1 月 6 日起至 104 年 1 月 5 日止免徵使用牌照稅，期滿後自 104 年 1 月 6 日起恢復課稅。

表 16 各項稅捐現行稅率表 (續 5)

稅別	課 徵 標 的	稅 率	
娛 樂 稅	一、舞廳、舞場	25 %	
	二、電影		
	1. 外國語片	(1) 市區繁榮地帶	2.5 %
		(2) 市區偏僻地帶	1.5 %
		(3) 郊區	1 %
	2. 本國語片	(1) 市區繁榮地帶	1 %
		(2) 市區偏僻地帶	1 %
		(3) 郊區	1 %
	三、高爾夫球練習場	2.5 %	
	四、職業性歌唱、舞蹈、馬戲、魔術、技藝表演及夜總會之各種表演。	5 %	
五、各種競技比賽及其他提供娛樂設施供人娛樂者。	2.5 %		
六、說書、戲劇、音樂演奏及非職業性歌唱、舞蹈等表	1.25 %		
契 稅	一、買賣契按契價	6 %	
	二、典權契按契價	4 %	
	三、交換契按契價	2 %	
	四、贈與契按契價	6 %	
	五、分割契按契價	2 %	
	六、占有契按契價	6 %	

表 16 各項稅捐現行稅率表（續 6 完）

稅別	應 稅 憑 證	稅 率 或 稅 額
印花稅	一、銀錢收據：	
	指收到銀錢所立之單據、簿、摺。	1. 每件按金額 4‰ 計貼。 2. 收受或領回押標金收據 每件按金額 1‰ 計貼。
	二、承攬契據：	
	指一方為他方完成一定工作之契據。	每件按金額 1‰ 計貼。
	三、典賣、讓受及分割不動產契據：	
	指設定典權及買賣、交換、贈與、分割不動產所立向主管機關申請物權登記之契據。	每件按金額 1‰ 計貼。
	四、買賣動產契據：	
	指買賣動產所立之契據。	每件稅額新臺幣 12 元。

附註：銀錢收據，如係收到票據(支票、匯票、本票)於收據上載明票據名稱及號碼者，免納印花稅。

表 17 各項稅捐劃解分配率

101 年度

單位：百分比

稅目	繳庫別	
	國	庫
地價稅	—	100
土地增值稅	—	100
房屋稅	—	100
使用牌照稅	—	100
契稅	—	100
印花稅	—	100
娛樂稅	—	100

表 18 本處各項稅捐稽徵工作流程圖

(一)地 價 稅



表 18 本處各項稅捐稽徵工作流程圖 (續 1)
(二)土地增值稅



表 18 本處各項稅捐稽徵工作流程圖 (續 2)

(三)房 屋 稅

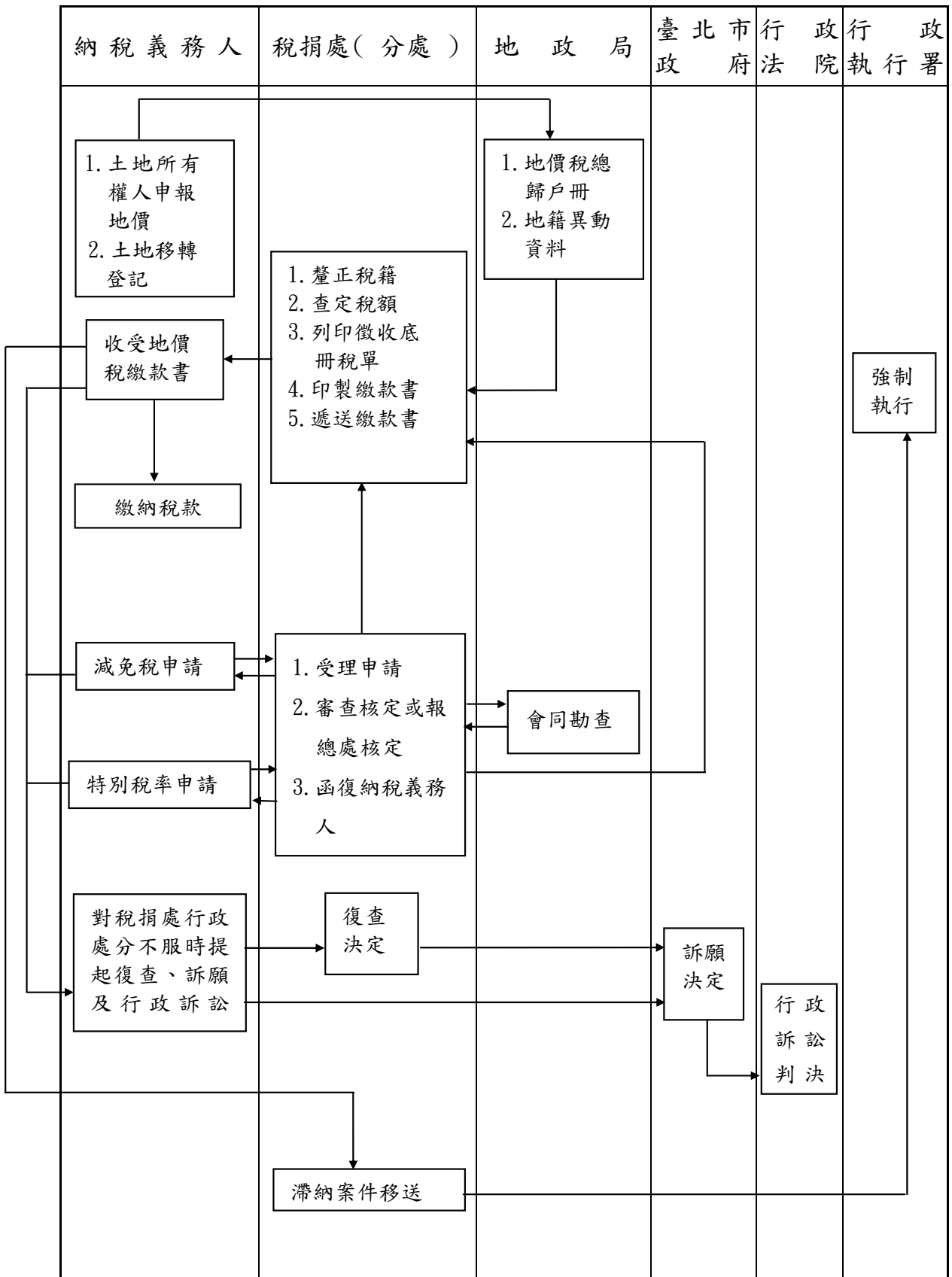

表 18 本處各項稅捐稽徵工作流程圖（續 3）

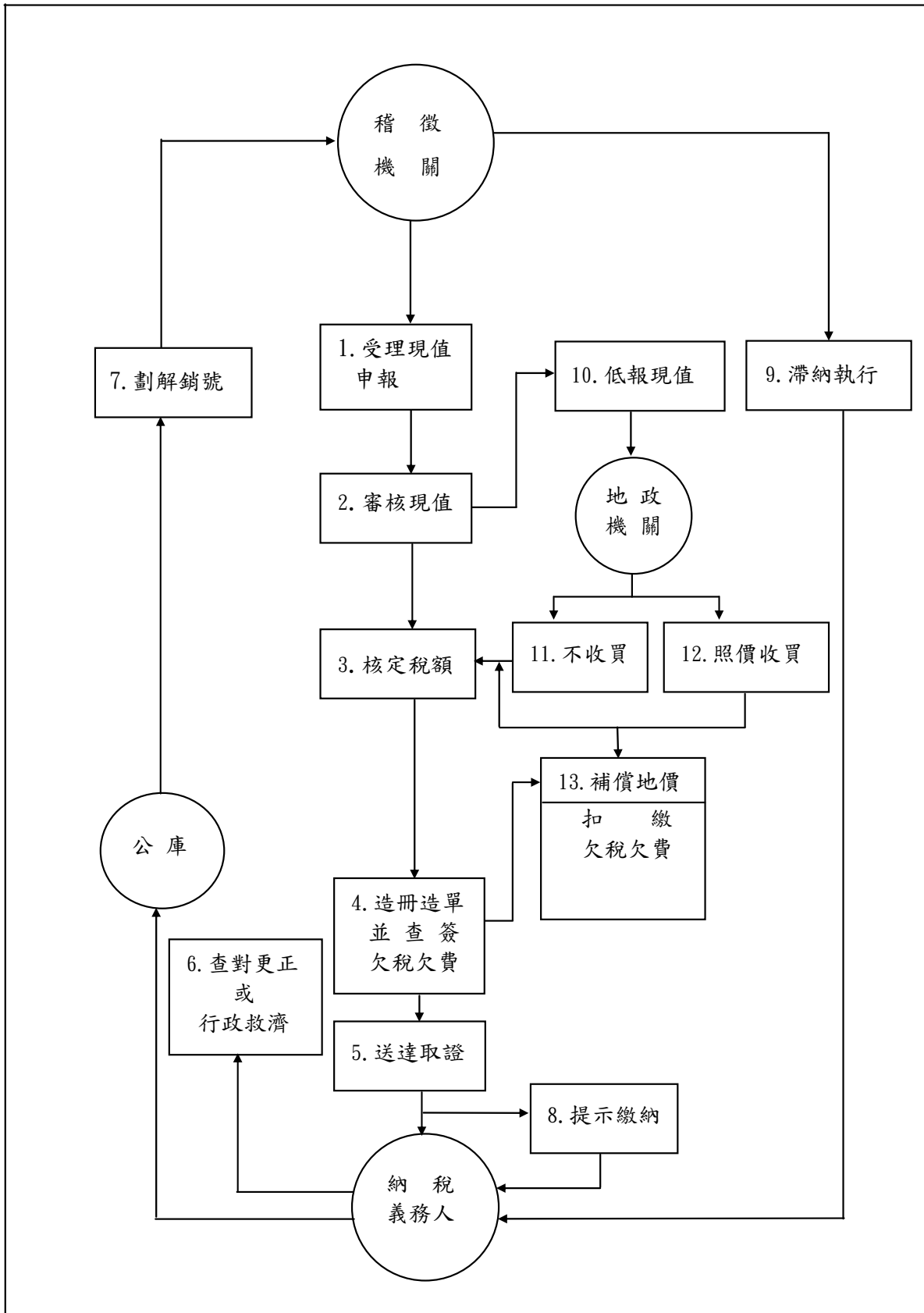
(四)使用牌照稅

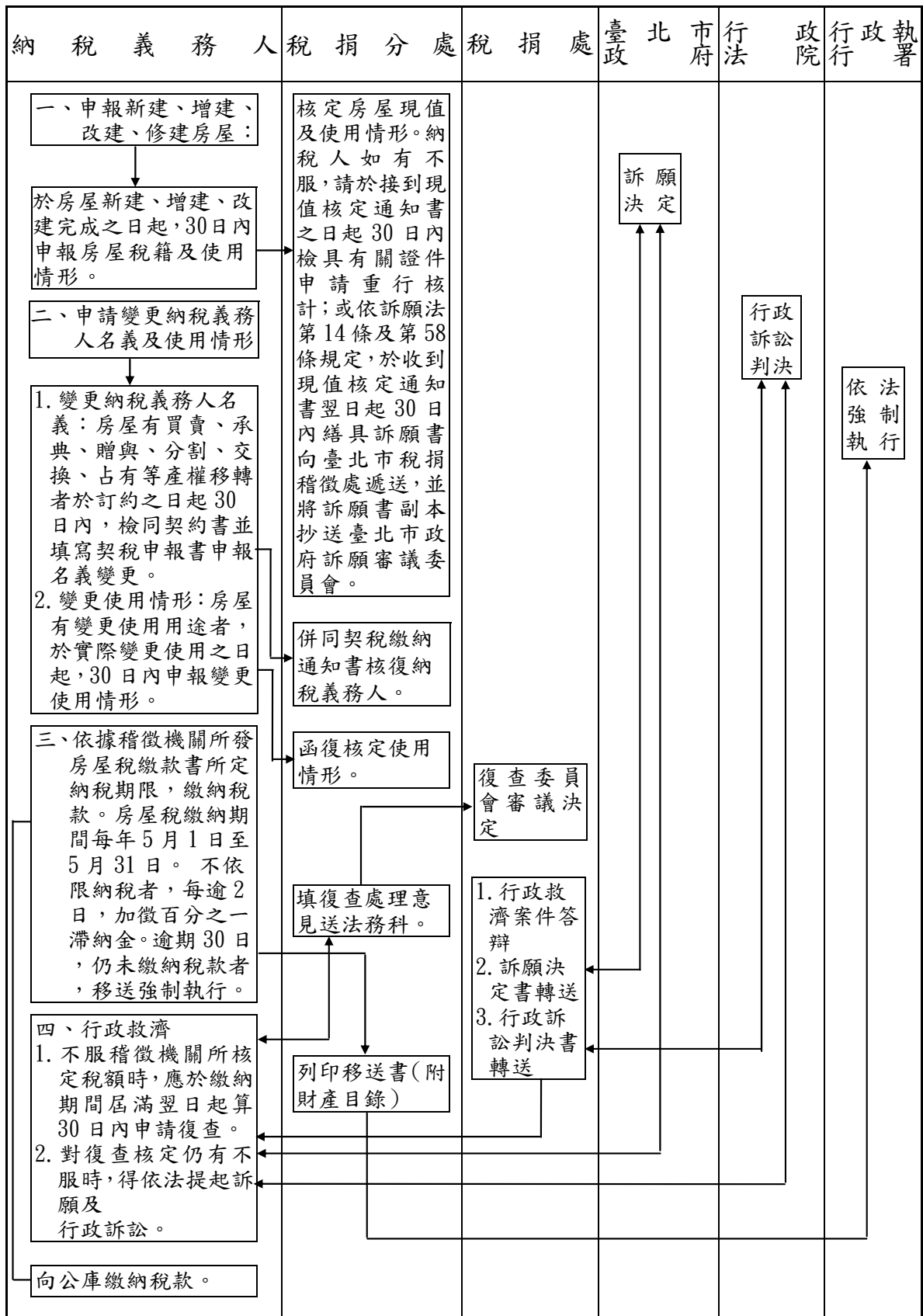

表 18 本處各項稅捐稽徵工作流程圖 (續 4)

(五)契 稅

納 稅 義 務 人	稅 捐 分 處	地 事 務 所	政 務 所 行 政 執 行 署	
<p>不動產所有權移轉契約成立之日起30日內申報契稅</p> <p>↓</p> <p>1. 公定格式契約書 2. 契稅申報書 3. 有關證件 4. 委託代理人申報者應在申報書內加蓋代理人印章</p> <p>↓</p> <p>向公庫繳納稅款後，將繳納通知書第5聯黏貼於買賣等契約書副本隨登記書表送地政機關存查</p> <p>↓</p> <p>未依限繳納稅款，每逾2日，加徵應納稅額百分之一滯納金，逾期30日仍不繳納者移送法院強制執行。</p>	<p>1. 審查契價 2. 核算稅額 3. 編冊造單 4. 遞送稅單</p> <p>↓</p> <p>列印財產目錄及移送書</p>	<p>產 權 變 更 登 記</p>	<p>強制執行</p>	
行 政 救 濟	稅 捐 處	臺 北 市 政 府	臺 北 高 等 行 政 法 院	最 高 行 政 法 院
<p>對核定稅額不服，應於繳納期間屆滿翌日起算30日內，申請復查。</p> <p>↓</p> <p>對復查決定不服</p> <p>↓</p> <p>提 起 訴 願</p> <p>↓</p> <p>行 政 訴 訟</p> <p>↓</p> <p>上 訴</p>	<p>復 查 決 定</p>	<p>訴 願 決 定</p>	<p>判 決</p>	<p>判 決</p>

表 18 本處各項稅捐稽徵工作流程圖 (續 5)
(六)印 花 稅

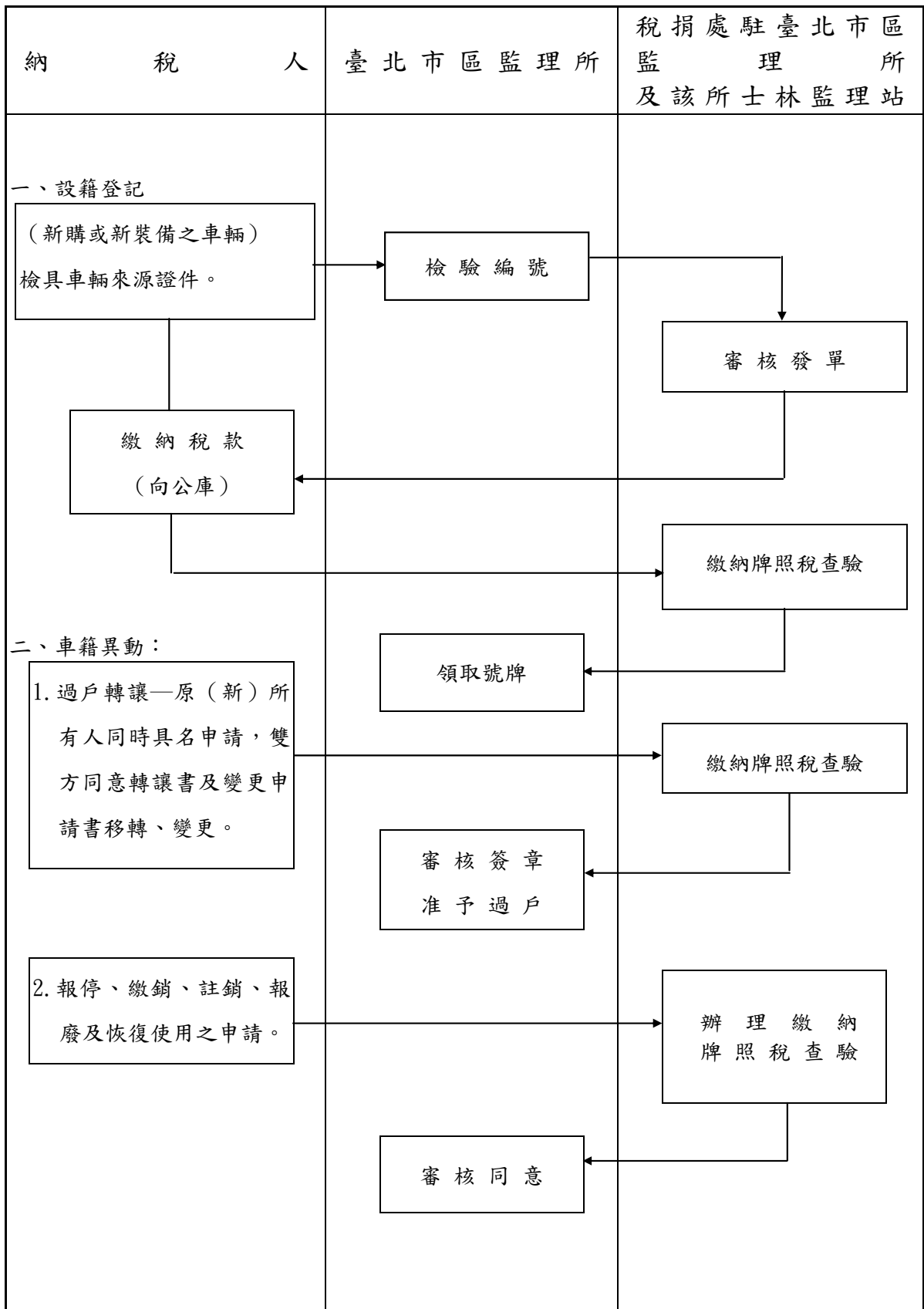

表 18 本處各項稅捐稽徵工作流程圖 (續 6)
(七) 娛樂稅



表 18 本處各項稅捐稽徵工作流程圖 (續 7 完)
(八) 支票退稅

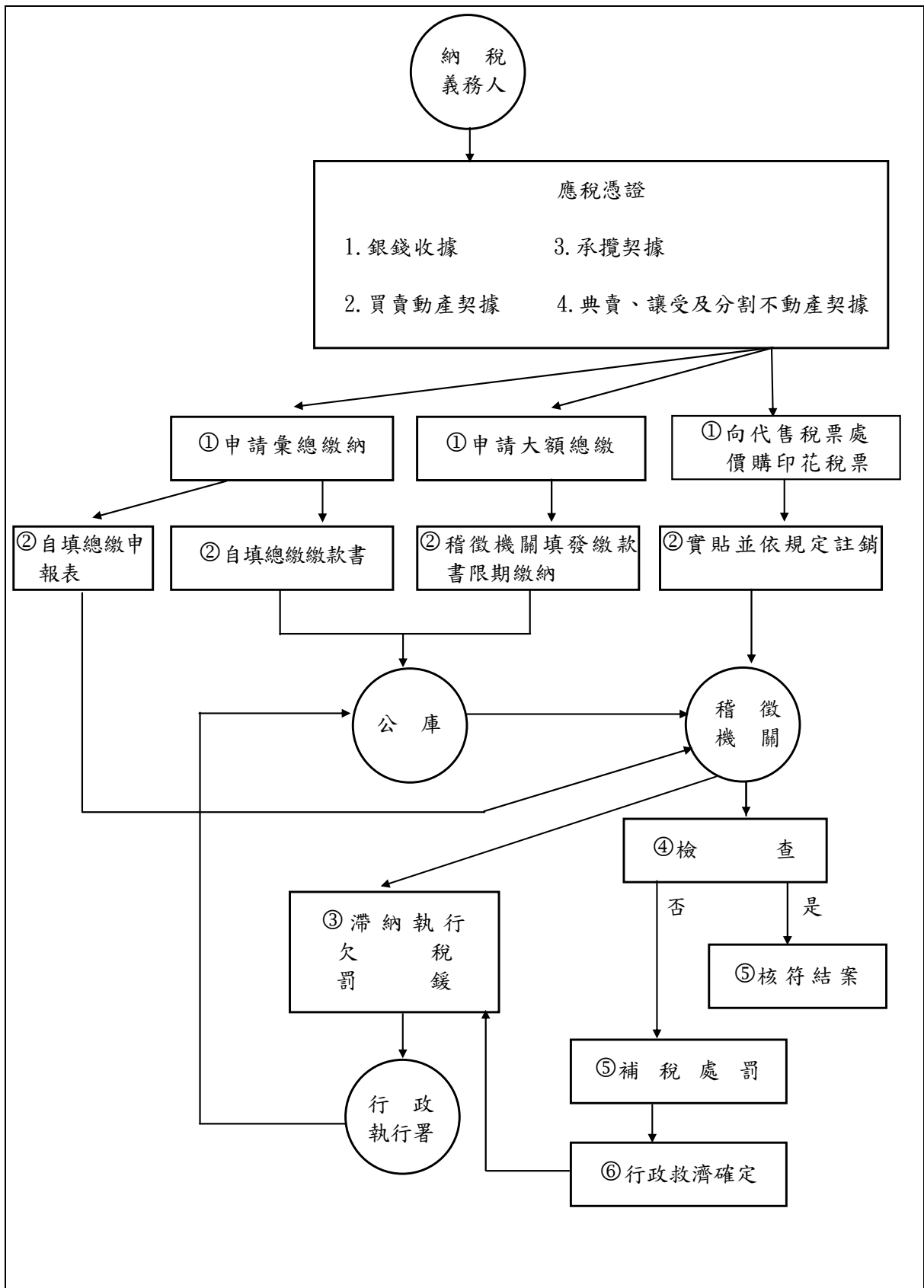

肆、行政組織

IV . Administrative Organization

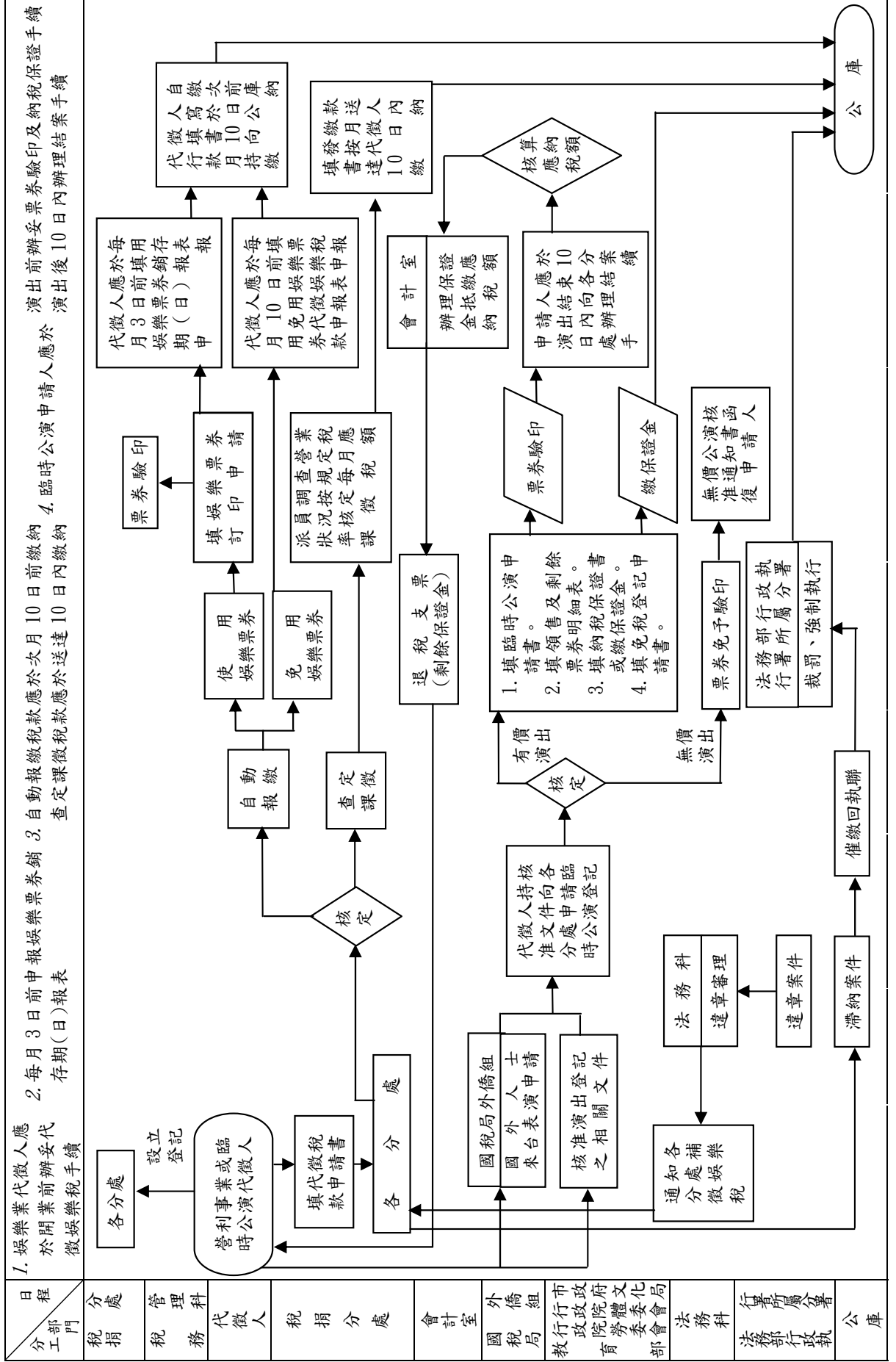
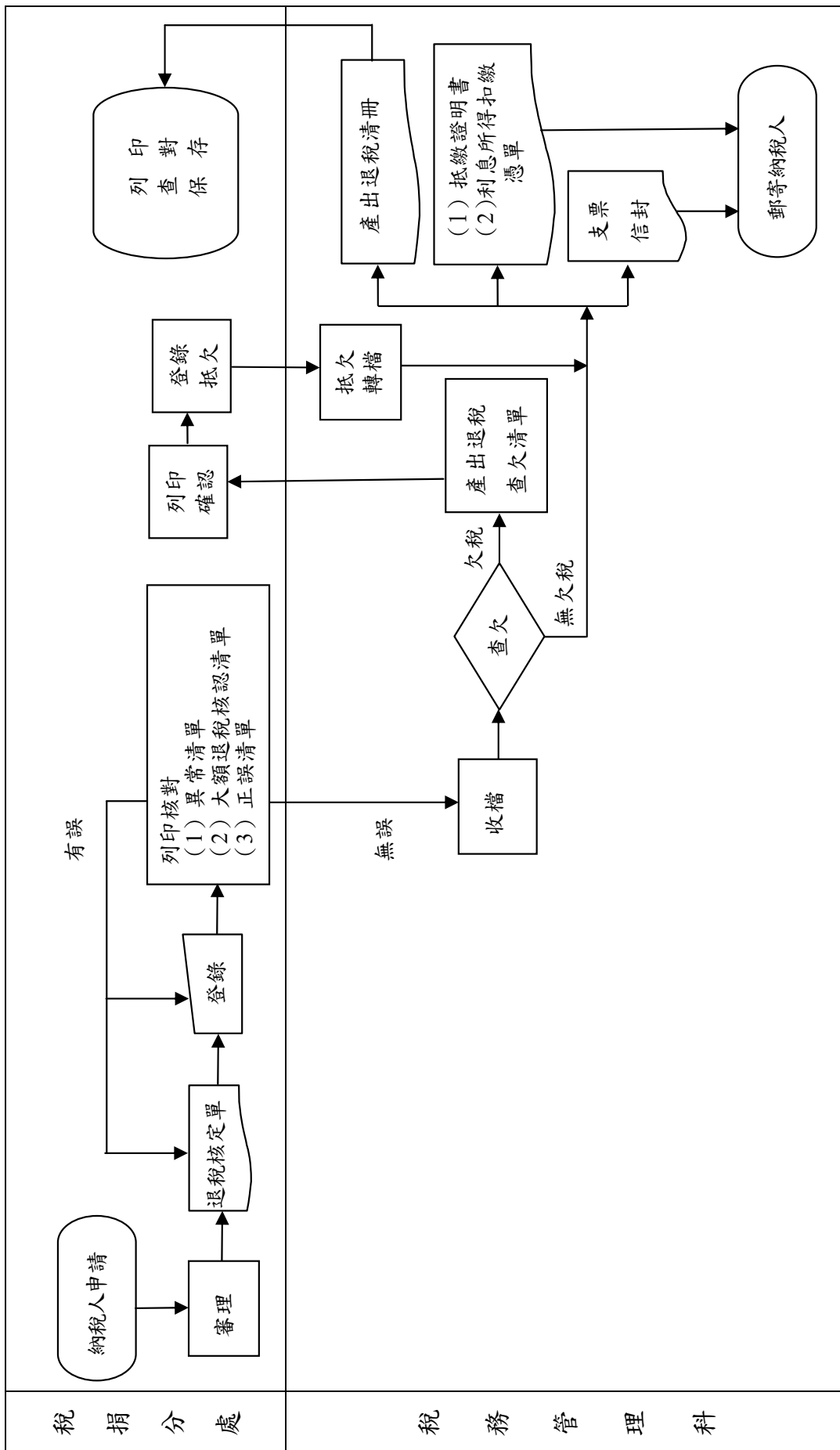
一、沿革

民國 34 年全省實施統一稽徵制度，臺北市設第一、第二稅務稽徵所管轄本市稅捐稽徵業務，民國 36 年 1 月合併成立臺北市稅捐稽徵處，下設 6 課及城中、中山、延平、萬華、古亭、松山等分處，掌理國、省、地方稅捐稽徵事宜，在系統上隸屬於臺北市政府而受臺灣省政府財政廳指揮監督。

民國 56 年 7 月臺北市改制為直轄市，財政部同時成立臺北市國稅局（102 年更名為財政部臺北國稅局）負責國稅之徵收，本處負責直轄市稅捐稽徵，並同時增設建成分處。民國 57 年 7 月，將市郊景美、木柵、南港、內湖及陽明山管理局之士林、北投等 6 鄉鎮正式劃入為臺北市管轄，除士林、北投另成立為陽明山管理局稅捐稽徵處外，景美、木柵 2 區成立景美分處，南港、內湖 2 區成立南港分處，隸屬於本處。民國 60 年 7 月，因大安區發展迅速，為加強便民服務，由古亭分處撥出成立大安分處。民國 63 年 1 月，原陽明山管理局稅捐稽徵處改隸本處，改設為士林分處。民國 75 年 1 月建成分處併入延平分處，士林分處劃出成立北投分處。民國 77 年 6 月增設內湖及大同 2 個分處。

民國 80 年 7 月，配合臺北市行政區調整為 12 區，本處按行政區域及業務情況設置 13 個分處，分別為中正（城中、古亭合併）、中北、中南（中山分出）、北投、萬華、信義（松山分出）、大安、松山、南港、文山（景美更名）、士林、內湖、大同（延平併入）等分處，就近為市民提供最便捷的納稅服務。

民國 88 年營業稅改制為國稅，仍由本處代徵，10 月為落實組織精簡，提升組織效能，實施組織重整並彈性調整各分處內部架構，業務量較大之大安、中南、中北、松山 4 個分處改設 5 個股，業務量較小之北投、內湖、南港、文山 4 個分處改設 3 個股，其餘大同、中正、信義、萬華、士林等 5 分處仍設 4 個股，並將娛樂稅、印花稅稽徵業務改由分處辦理。

民國 92 年 1 月營業稅移撥由財政部臺北市國稅局稽徵。本處負責房屋稅、地價稅、土地增值稅、契稅、使用牌照稅、娛樂稅、印花稅等地方稅及工程受益費之稽徵。同時重新訂定組織架構，將總處調整為 5 科 5 室，分處仍維持不變，除大安分處設置 4 個股外，其餘分處設置 3 個股。為因應業務需要增設第 2 位副處長職位，於 94 年 1 月正式派任。

民國 95 年 1 月為擴增服務據點，使用牌照稅業務比照其他稅目，將稽徵作業之執行改由分處辦理，人員配合移撥分處。松山分處因牌照稅業務量及員額配置較多，專設 1 股辦理該項業務，改置為 4 個股，至民國 100 年 9 月為配合使用牌照稅稽徵業務回歸機會稅科管理，復調整為 3 個股。

臺北市稅捐稽徵處暨所屬各分處稽徵區域圖

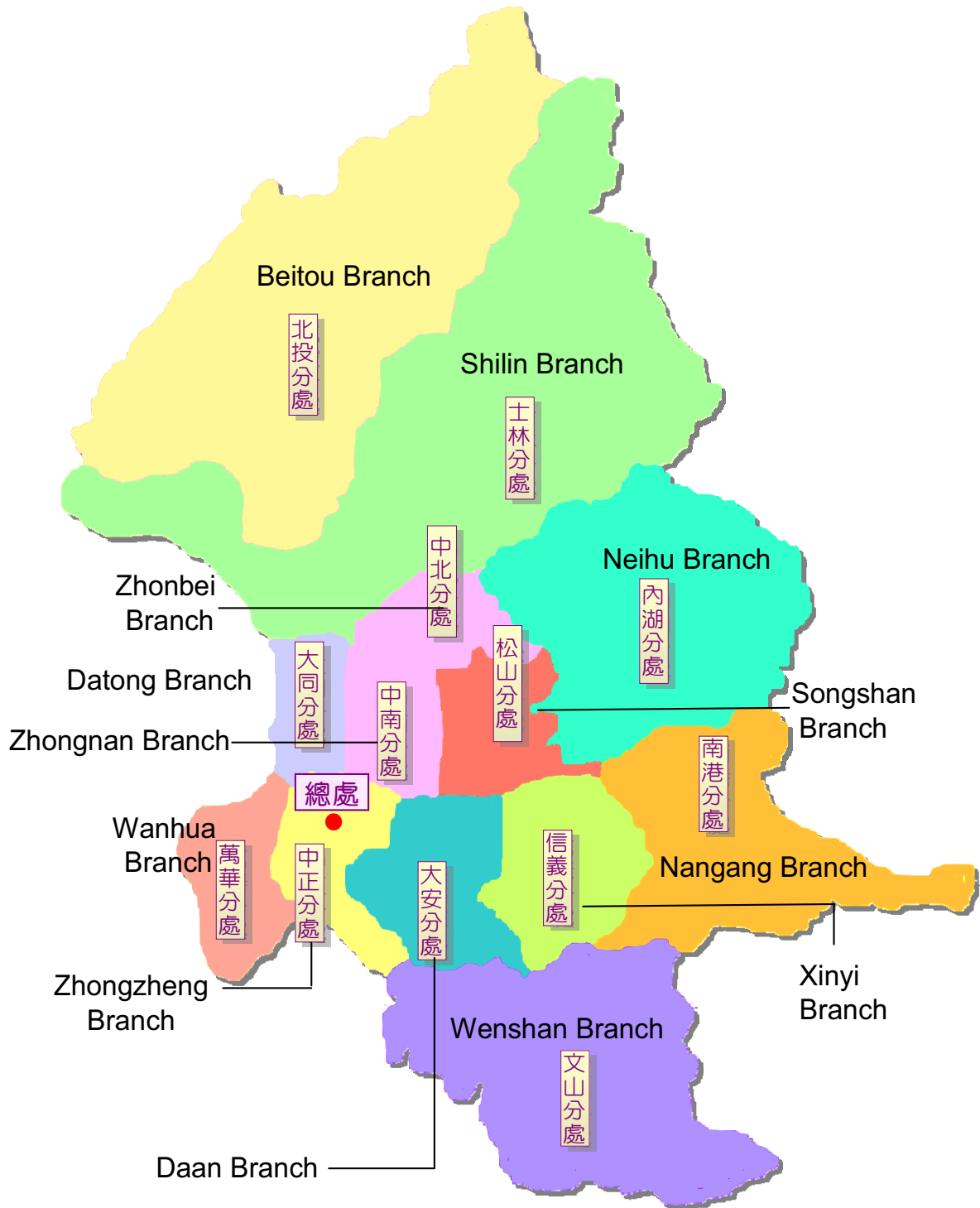

二、組織

本處組織：

依據臺北市政府 93 年 7 月 30 日府法三字第 09312725300 號令，「臺北市稅捐稽徵處組織規程」核定本處隸屬於臺北市政府財政局，置處長 1 人，綜理處務，並置副處長 2 人襄理處務，下設 5 科 5 室及 13 個分處掌理各項地方稅捐稽徵業務。

臺北市稅捐稽徵處組織圖

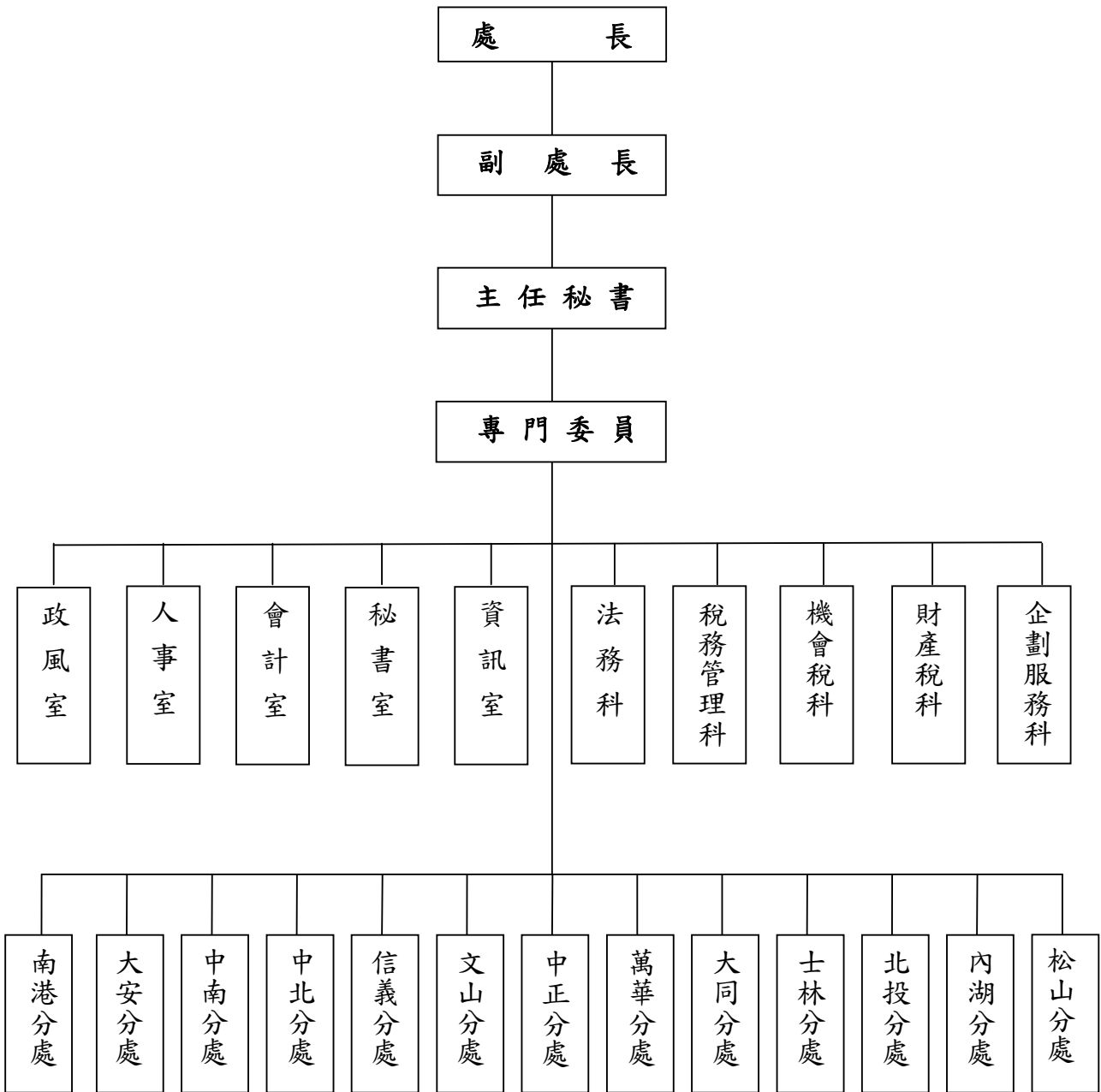

三、人事

本處奉准編制員額 846 人，民國 101 年 12 月底現有職員 733 人。現有人員按學歷別分析，研究所畢業者 56 人占 7.7%，大專畢業者 631 人占 86.1%，高中(職)畢業者 45 人占 6.1%，國中畢業者 1 人占 0.1%；按考試及格別來看，其中高等考試及格者 164 人占 22.4%，普通考試及格者 93 人占 12.7%，特種考試及格者 326 人占 44.5%，升等考試及格者 91 人占 12.4%，初等考試及格者 26 人占 3.5%，其他考試及格者 31 人占 4.2%，依其他法令進用者 2 人占 0.3%；按年齡別分，20 歲至 29 歲 101 人占 13.8%，30 歲至 39 歲 185 人占 25.2%，40 歲至 49 歲 236 人占 32.2%，50 歲至 59 歲 197 人占 26.9%，60 歲以上 14 人占 1.9%，平均年齡為 42.3 歲。



表 19 本處人事概況
(一)法定員額與現有員額
101年12月底

單位：人

職 稱	Position	法定員額 Budget Staff		現有員額 Actual Staff	備 註	
		職 等	員 額			
總 計	Total		846	733	本表法定員額係奉 臺北市政府 93 年 7 月 30 日府法三字第 09312725300 號令核 定之員額。	
處 長	Director	第 十 一 職 等	1	1		
副 處 長	Deputy Director	第 十 職 等	2	2		
主 任 秘 書	Chief Secretary	第 九 職 等	1	1		
專 門 委 員	Senior Specialist	第 九 職 等	2	1		
科 長	Section Chief	第 八 職 等	5	5		
分 處 主 任	Manager, Branch	第 八 至 九 職 等	13	12		
主 任	Chief	第 八 職 等	2	2		
秘 書	Secretary	第 七 至 八 職 等	3	3		
督 導	Inspector	第 七 至 八 職 等	3	2		
審 核 員	Revenue Assessor	第 七 至 八 職 等	19	18		
專 員	Specialist	第 七 至 八 職 等	1	1		
股 長	Sub-section Chief	第 七 職 等	62	61		
分 析 師	Systems Analyst	第 七 職 等	2	2		
設 計 師	Systems Designer	第 五 或 六 至 七 職 等	14	13		
管 理 師	Systems Coordinator	第 五 或 六 至 七 職 等	4	4		
助 理 設 計 師	Assistant Systems Designer	第 三 至 五 職 等	6	5		
助 理 管 理 師	Assistant Systems Coordinator	第 三 至 五 職 等	1	1		
稅 務 員	Revenue Officer	第 五 或 六 至 七 職 等	344	314		
助 理 稅 務 員	Revenue Assistant	第 三 至 五 職 等	167	154		
科 員	Section Assistant	第 五 或 六 至 七 職 等	6	6		
辦 事 員	Senior Clerk	第 三 至 五 職 等	19	18		
書 記	Clerk	第 一 至 三 職 等	124	66		(內 3 人俟雇員出 缺後改置)

續下頁

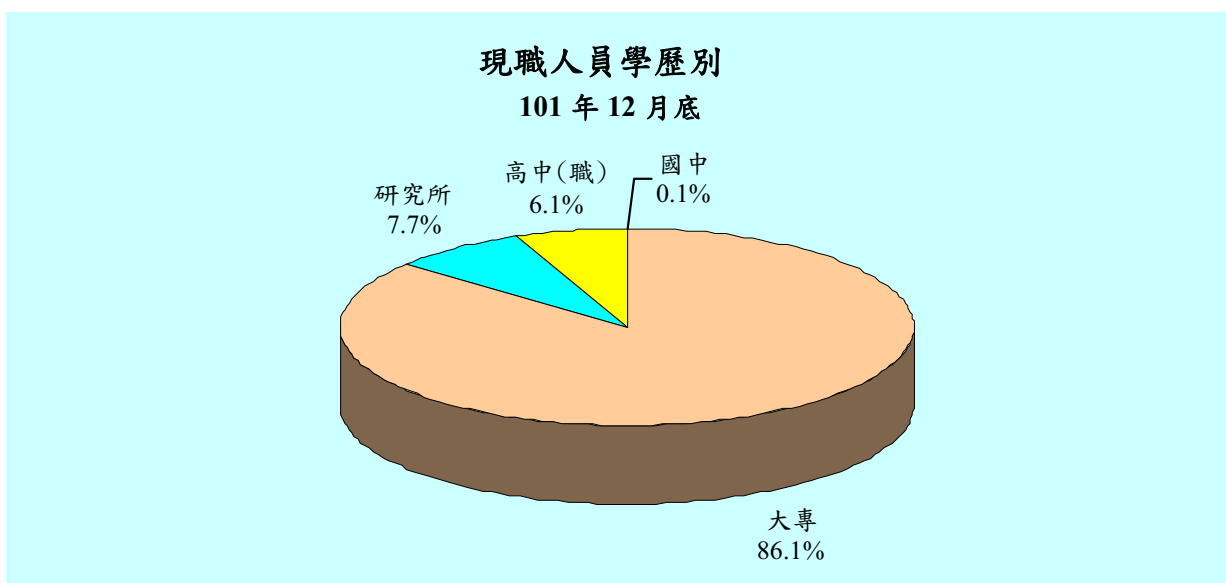
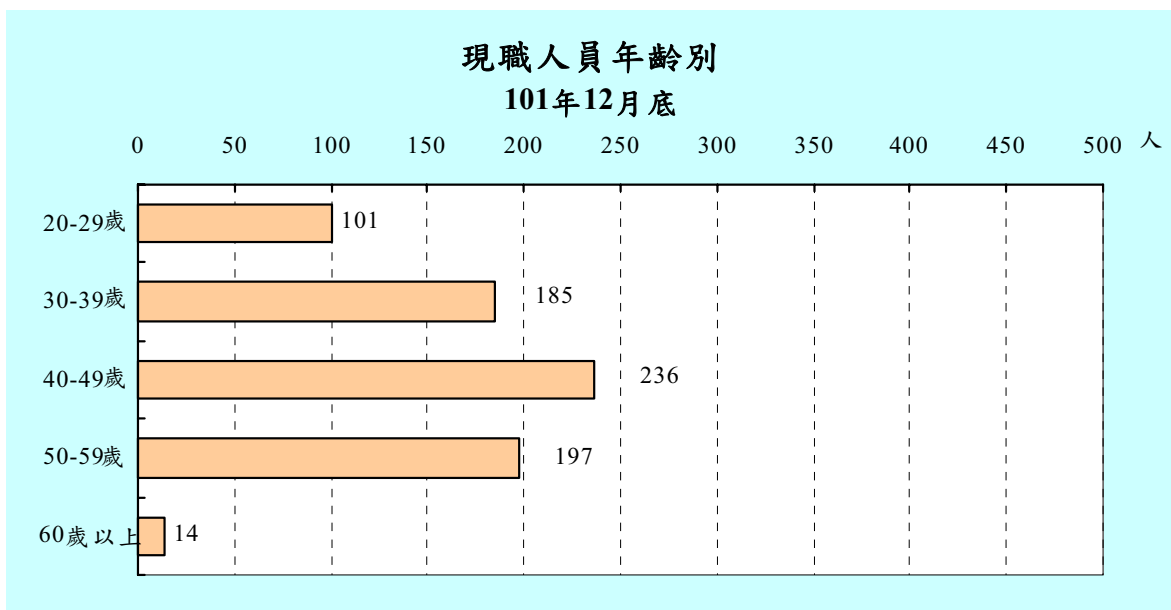
表 19 本處人事概況(續 1)

(一)法定員額與現有員額

101 年 12 月底

單位：人

職 稱 Position	法定員額 Budget Staff		現有員額 Actual Staff	備 註	
	職 等	員 額			
會計室 Accounting office	會計主任 Chief Accounting Officer	第 八 職 等	1	1	
	專員 Specialist	第 七 至 八 職 等	1	1	
	股長 Sub- section Chief	第 七 職 等	4	4	
	科員 Section Assistant	第 五 或 六 至 七 職 等	11	11	
	辦事員 Senior Clerk	第 三 至 五 職 等	1	1	
	書記 Clerk	第 一 至 三 職 等	2	-	
	人 事 室 Personnel Office	主任 Chief Personnel Officer	第 八 職 等	1	1
專員 Specialist		第 七 至 八 職 等	1	1	
股長 Sub- section Chief		第 七 職 等	3	3	
科員 Section Assistant		第 五 或 六 至 七 職 等	8	7	
助理員 Assistant		第 四 至 五 職 等	2	2	(內 1 人得列 薦任)
書記 Clerk		第 一 至 三 職 等	1	1	
政 風 室 Government Ethics Office		主任 Chief Government Ethics Officer	第 八 職 等	1	1
	股長 Sub- section Chief	第 七 職 等	2	2	
	科員 Section Assistant	第 五 或 六 至 七 職 等	4	3	
	辦事員 Senior Clerk	第 三 至 五 職 等	1	1	
	書記 Clerk	第 一 至 三 職 等	1	1	

附註：根據本處人事室資料編製。

表 19 本處人事概況(續 2)

(二) 年齡與職等、性別

101 年 12 月底

單位：人

年 齡 age	官 等 Official Classes					性 別 Sex		
	共 計 Total	10-14 職 等 Selected Appointment	6-9 職 等 Recommended Appointment	1-5 職 等 Delegated Appointment	雇 員 Assistant Clerk	共 計 Total	男 Male	女 Female
總 計 Grand Total	733	3	361	366	3	733	152	581
20 歲 - 29 歲	101	—	32	69	—	101	21	80
30 歲 - 39 歲	185	—	95	90	—	185	40	145
40 歲 - 49 歲	236	—	131	105	—	236	35	201
50 歲 - 59 歲	197	1	97	96	3	197	52	145
60 歲 以 上	14	2	6	6	—	14	4	10

(三) 學歷及考試

101 年 12 月底

單位：人

學 歷 及 考 試 別 Educational & Examination	共 計 Total	10-14 職 等 Selected Appointment	6-9 職 等 Recommended Appointment	1-5 職 等 Delegated Appointment	雇 員 Assistant Clerk
(1) 學 歷 Education	733	3	361	366	3
研 究 所 Graduate School	56	—	46	10	—
大 專 Junior College	631	3	309	317	2
高 中 (職) Senior High School	45	—	6	38	1
國 (初) 中 及 以 下 Junior High School and Under	1	—	—	1	—
(2) 考 試 Examination	733	3	361	366	3
高 等 考 試 Senior Civil Service Exam.	164	—	148	16	—
普 通 考 試 Junior Civil Service Exam.	93	—	32	61	—
特 種 考 試 Special Civil Service Exam.	326	2	122	202	—
升 等 考 試 Rank Promotion Service Exam.	91	1	47	43	—
初 等 考 試 Elementary Civil Service Exam.	26	—	—	26	—
其 他 考 試 Other Civil Service Exam.	31	—	12	16	3
依 其 他 法 令 進 用 By Other Means	2	—	—	2	—

表 19 本處人事概況(續 3 完)

(四)年 資
101 年 12 月底

單位：人

年 資 Seniority	共 計 Total	10-14 職等 Selected Appointment	6-9 職等 Recommended Appointment	1-5 職等 Delegated Appointment	雇 員 Assistant Clerk
總 計 Grand Total	733	3	361	366	3
5 年 以 下	274	—	115	159	—
6 年— 9 年	81	—	27	54	—
10 年—14 年	84	—	40	44	—
15 年—19 年	149	—	74	73	2
20 年—24 年	70	—	45	25	—
25 年—29 年	41	1	31	9	—
30 年 以 上	34	2	29	2	1

(五)工 作 類 別

101 年 12 月底

單位：人

工 作 類 別 Job	共 計 Total	10-14 職等 Selected Appointment	6-9 職等 Recommended Appointment	1-5 職等 Delegated Appointment	雇 員 Assistant Clerk
總 計 Grand Total	733	3	361	366	3
行 政	63	—	9	54	—
財 政	595	3	308	284	—
人 事	15	—	10	5	—
會 計	18	—	11	7	—
雇 員	3	—	—	—	3
資 訊 處 理	31	—	18	13	—
政 風	8	—	5	3	—
安 全 保 防	—	—	—	—	—

表 20 本處歲出預決算數

單位：新臺幣元

年度及科目別	預 算		決 算		決算數 占預算數 之比率 % (2/1)×100
	金 額 (1)	%	金 額 (2)	%	
92 年 度	1,026,447,483	100.0	977,386,545	100.0	95.2
93 年 度	1,001,426,569	100.0	948,839,912	100.0	94.7
94 年 度	922,830,712	100.0	908,367,765	100.0	98.4
95 年 度	929,515,635	100.0	918,257,368	100.0	98.8
96 年 度	917,289,764	100.0	895,615,954	100.0	97.6
97 年 度	923,887,755	100.0	895,044,198	100.0	96.9
98 年 度	925,665,198	100.0	898,324,537	100.0	97.0
99 年 度	910,138,102	100.0	898,108,142	100.0	98.7
100 年 度	924,158,185	100.0	915,283,662	100.0	99.0
101 年 度	926,239,026	100.0	898,931,066	100.0	97.1
一般行政	167,913,295	18.1	166,108,105	18.5	98.9
行政管理	167,913,295	18.1	166,108,105	18.5	98.9
稅捐稽徵業務	744,345,437	80.4	723,657,625	80.5	97.2
財產稅稽徵	360,570,869	38.9	356,767,558	39.7	98.9
機會稅稽徵	68,631,028	7.4	63,964,090	7.1	93.2
稅務管理	215,231,083	23.2	209,339,564	23.3	97.3
違章及行政救濟	15,788,239	1.7	15,241,687	1.7	96.5
電子處理資料	84,124,218	9.1	78,344,726	8.7	93.1
建築及設備	13,980,294	1.5	9,165,336	1.0	65.6
營建工程	10,218,894	1.1	5,531,834	0.6	54.1
其他設備	1,251,600	0.1	1,123,702	0.1	89.8
土地購置	2,509,800	0.3	2,509,800	0.3	100.0

資料來源：依據審計部臺北市審計處審核決算審定書編製。

附 註：1. 本表未包括統籌科目。

2. 101年度決算數尚未經審計部臺北市審計處審定。

中華民國 101 年度 臺北市稅捐統計年報

發行機關：臺北市稅捐稽徵處

發行人：黃素津

編輯：臺北市稅捐稽徵處會計室

地址：臺北市中正區北平東路 7 之 2 號

電話：(02)23949211 分機 341

網址：www.tpctax.taipei.gov.tw

創刊日期：中華民國 42 年 2 月

出刊日期：中華民國 102 年 3 月

出刊頻率：年刊

本刊登載於本處網站