

中華民國103年度
臺北市稅捐統計年報

YEARBOOK OF MUNICIPAL TAX
STATISTICS OF TAIPEI CITY
2014



臺北市稅捐稽徵處
TAIPEI CITY **R**EVENUE **S**ERVICE
104年3月編製

編 製 說 明

- 一、本刊之編製，旨在提供本處稽徵業務執行與成果資料，以為公務計畫、執行、考核及財務管理上之參考。
- 二、本刊資料內容包括稅收概況、稅收統計、稅源及其他、行政組織等 4 大項。
- 三、本刊所稱「年度」係指政府會計年度，採曆年制(當年 1 月 1 日至同年 12 月 31 日)。
- 四、本刊數字因尾數四捨五入，故部分總數與細項之間，或有未能吻合情事，計算時仍以原始數據計算。
- 五、本刊所有符號「—」表示無數值，「--」表示無意義數值，「...」表示數值不明或尚未產生資料，「0」表示有數值而不及半單位，數字前加(-)者表示退稅或減免數，(+)者表示增加數，「Ⓘ」表示修正數。
- 六、本刊以前各期數字，若與本期有出入者，以本期所列數字為準。

目 次

壹、稅收概況

一、103 年度稅收概況	2
二、近 10 年稅收	3
三、地價稅	4
四、土地增值稅	5
五、房屋稅	6
六、使用牌照稅	7
七、契稅	8
八、印花稅	9
九、娛樂稅	10

貳、稅收統計

表 1 各項稅捐徵績比較	12
表 2 歷年各項稅捐預算數、查定數與實徵數	
(一)總計	14
(二)稅課收入	
1. 合計	16
2. 地價稅	18
3. 土地增值稅	20
4. 房屋稅	22
5. 使用牌照稅	24
6. 契稅	26
7. 印花稅	28
8. 娛樂稅	30

CONTENTS

I. Analysis of Revenues from Taxes

A. Tax Revenues in 2014	2
B. Tax Revenues in Nearly 10 Years	3
C. Land Value Tax	4
D. Land Value Increment Tax	5
E. House Tax	6
F. Vehicle License Tax	7
G. Deed Tax	8
H. Stamp Tax	9
I. Amusement Tax	10

II. Tax Revenue Statistics

Table 1. Net Tax Revenues Compare	12
Table 2. Budget Amount, Audited Amount and Actual Collection in Recent Years	
(I) Grand Total	14
(II) Revenues from Taxes	
1. Total	16
2. Land Value Tax	18
3. Land Value Increment Tax	20
4. House Tax	22
5. Vehicle License Tax	24
6. Deed Tax	26
7. Stamp Tax	28
8. Amusement Tax	30

9. 九年國民義務教育附徵教育經費

(1)小計	32
(2)房屋稅	34
(3)娛樂稅	36
(三)工程受益費	38
(四)罰鍰收入	40
(五)規費收入	42
表 3 各項稅捐納庫數	
(一)歷年別	44
(二)稅目別	46
表 4 歷年各項稅捐實徵淨額及指數	48
表 5 本處各項稅捐稽徵成本	52

參、稅源及其他

表 6 地價稅稅源	54
表 7 土地增值稅稅源	56
表 8 房屋稅稅源	58
表 9 使用牌照稅稅源	62
表 10 契稅稅源	64
表 11 印花稅稅源	66
表 12 娛樂稅稅源	68
表 13 違章漏稅案件處理及財務罰鍰執行情形表	72
表 14 各項稅捐滯納案件移送執行情形	76
表 15 查(核)定開徵數及未徵數情形	78

9. Education Surtax	
(1) Subtotal	32
(2) House Tax	34
(3) Amusement Tax	36
(III) Construction Benefit Fee	38
(IV) Punitive Fine Revenue	40
(V) Fees Revenue	42
Table 3. Taxation Forwarded to Treasury	
(I) Fiscal Year	44
(II) Item of Tax	46
Table 4. Net Amount Remitted and Index in Recent Years	48
Table 5. Cost of Tax Levying	52

III. Tax Sources and Others

Table 6. Sources of Land Value Tax	54
Table 7. Sources of Land Value Increment Tax	56
Table 8. Sources of House Tax	58
Table 9. Sources of Vehicle License Tax	62
Table 10. Sources of Deed Tax	64
Table 11. Sources of Stamp Tax	66
Table 12. Sources of Amusement Tax	68
Table 13. The Management of Cases of Tax Evasion Against Law and Execution Status of Fine	72
Table 14. The Status of Delayed Case Transferred to Execution	76
Table 15. The Management of Opening Collection for Assessed(Verified) and of Tax Not Collected	78

表 16 各項稅捐現行稅率表	86
表 17 各項稅捐劃解分配率	93
表 18 本處各項稅捐稽徵工作流程圖	
(一)地價稅	94
(二)土地增值稅	95
(三)房屋稅	96
(四)使用牌照稅	97
(五)契稅	98
(六)印花稅	99
(七)娛樂稅	100
(八)支票退稅	101

肆、行政組織

一、沿革 (附圖)	105
二、組織 (附圖)	107
三、人事 (附圖)	109
表 19 本處人事概況	
(一)法定員額與現有員額	110
(二)年齡與職等、性別	112
(三)學歷及考試	112
(四)年資	113
(五)工作類別	113
表 20 本處歲出預決算數	114

Table 16. Current Tax Rates for Taxation	86
Table 17. The Distribution Rates of Tax	93
Table 18. Work Flow Chart	
(I) Land Value Tax	94
(II) Land Value Increment Tax	95
(III) House Tax	96
(IV) Vehicle License Tax	97
(V) Deed Tax	98
(VI) Stamp Tax	99
(VII) Amusement Tax	100
(VIII) Check Refund	101

IV. Administrative Organization

A. The History	105
B. Organization	107
C. Personnel	109
Table 19. Personnel Statistic	
(I) Personnel Management & Present Personnel	110
(II) By Age & Official Class & Sex	112
(III) By Educational Attainment & Recruitment Way	112
(IV) By Length of Service	113
(V) Work Type	113
Table 20. Budget and Closed Account of Expenditures	114

壹、稅收概況

I . Analysis of Revenues from Taxes

一、103 年度稅收概況

103 年度本市地方稅稅收實徵淨額 672.91 億元，較預算數 630.75 億元，超徵 42.16 億元，年度預算達成率 106.7%，除契稅因交易量減少，且移轉房屋大多屬經歷年數 10 年以上之舊屋，房屋現值偏低，短徵 1.49 億元外，其餘各稅均超徵，其中土地增值稅因土地公告現值調漲及大筆土地移轉，實徵淨額 190.67 億元，超徵 20.67 億元為最多，其次是地價稅因稅籍及使用情形清查作業執行績效優異，實徵淨額為 224.48 億元，超徵 12.48 億元，餘使用牌照稅、印花稅、房屋稅及娛樂稅分別超徵 5.14 億元、2.99 億元、2.17 億元及 0.2 億元。

103 年度地方稅稅課收入

單位：新臺幣億元

項目 稅目	預算數 (1)	實徵淨額 (2)	超(短)徵		預算達成率 (5)=(2)/(1)*100
			金額 (3)=(2)-(1)	百分比 (4)=(3)/(1)	
稅課收入	630.75	672.91	42.16	6.7%	106.7%
地價稅	212.00	224.48	12.48	5.9%	105.9%
土地增值稅	170.00	190.67	20.67	12.2%	112.2%
房屋稅	120.00	122.17	2.17	1.8%	101.8%
使用牌照稅	66.00	71.14	5.14	7.8%	107.8%
契稅	18.00	16.51	-1.49	-8.3%	91.7%
印花稅	42.60	45.59	2.99	7.0%	107.0%
娛樂稅	2.15	2.35	0.20	9.2%	109.2%
教育經費	—	0.00	--	--	--

103 年度各稅比重

實徵淨額總計 672.91 億元

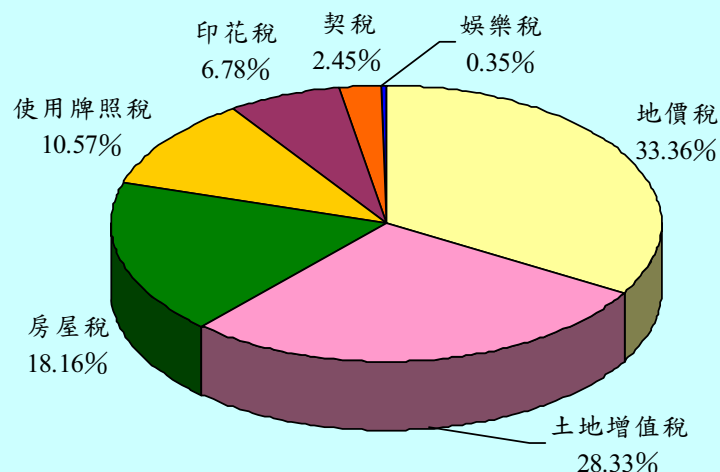

二、近 10 年稅收

近 10 年稅課收入

單位：新臺幣億元

年度別	預算數	實徵淨額	超(短)徵		實徵淨額與上年度增減比較	
			金額	百分比	金額	百分比
94	497.93	603.32	105.39	21.2%	--	--
95	518.28	593.34	75.06	14.5%	-9.98	-1.7%
96	530.93	616.96	86.03	16.2%	23.62	4.0%
97	540.34	565.71	25.37	4.7%	-51.25	-8.3%
98	535.20	573.45	38.25	7.1%	7.74	1.4%
99	527.10	608.45	81.35	15.4%	35.00	6.1%
100	562.68	619.99	57.31	10.2%	11.54	1.9%
101	610.50	621.89	11.39	1.9%	1.90	0.3%
102	604.30	663.11	58.81	9.7%	41.22	6.6%
103	630.75	672.91	42.16	6.7%	9.80	1.5%

近 10 年稅課收入預算數與實徵淨額

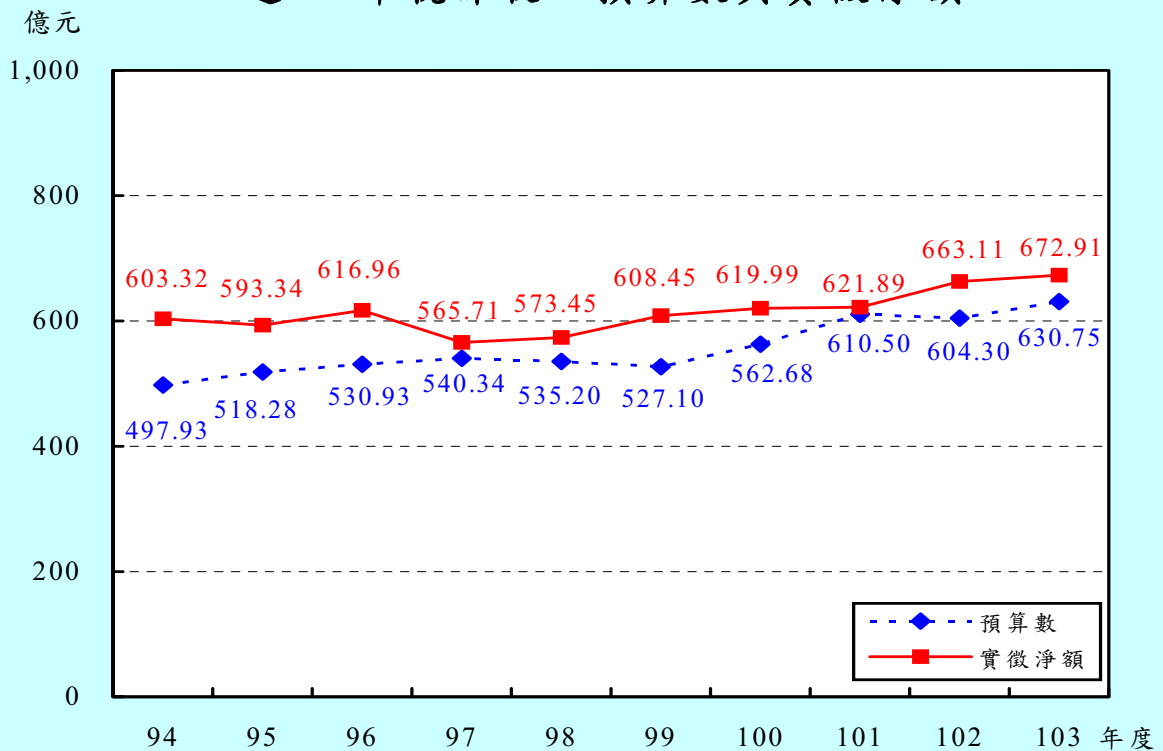

三、地價稅

103 年度實徵淨額 224.48 億元，與預算數 212 億元比較，增加 12.48 億元，超徵 5.9%；較上年度實徵淨額 220.86 億元增加 3.62 億元，成長 1.6%。

因市府轉運站記帳緩繳稅款 1.6 億元於 103 年 4 月 23 日入帳，及執行 103 年度地價稅清查作業績效優異和地價稅開徵徵起率較以前年度為高，致稅收超徵且較上年度增加。

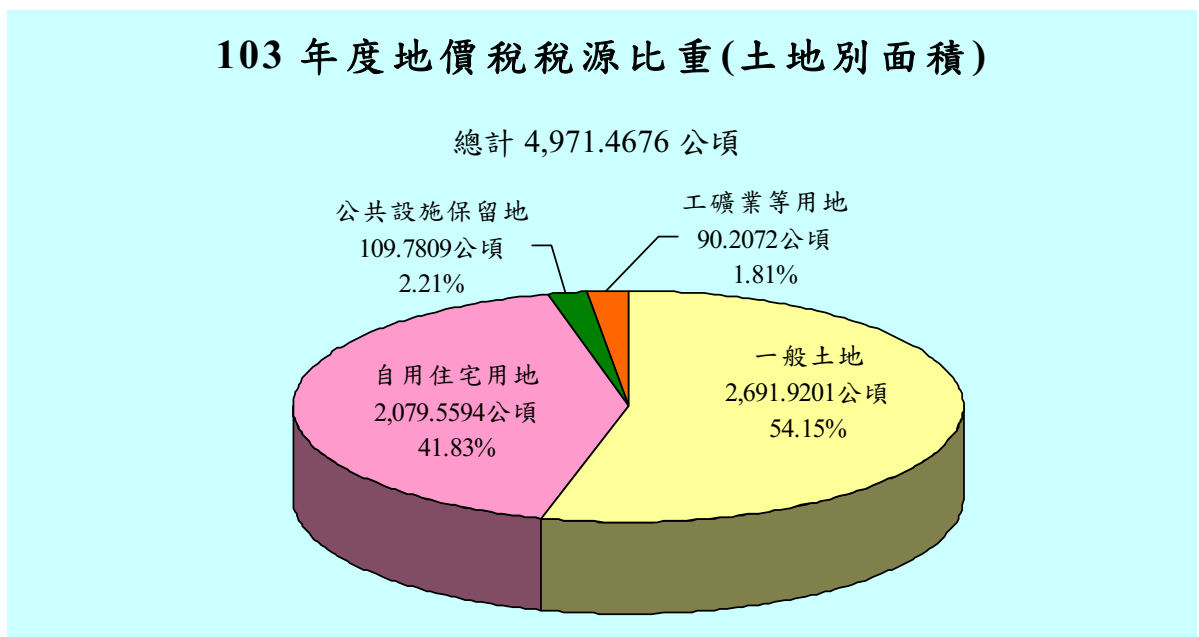
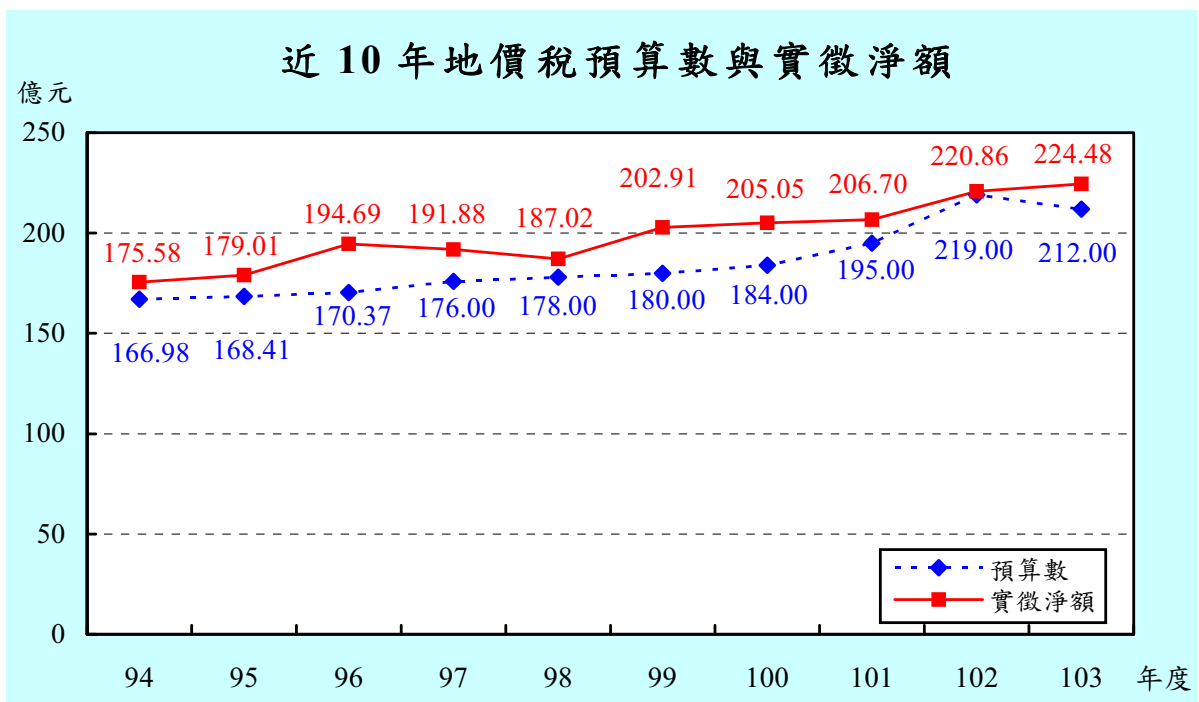

四、土地增值稅

103 年度實徵淨額 190.67 億元，與預算數 170 億元比較，增加 20.67 億元，超徵 12.2%；較上年度實徵淨額 189.73 億元增加 0.94 億元，成長 0.5%。

本年度因公告土地現值平均調漲 13.23% 且有大筆土地移轉，致稅收超徵且較上年度增加。

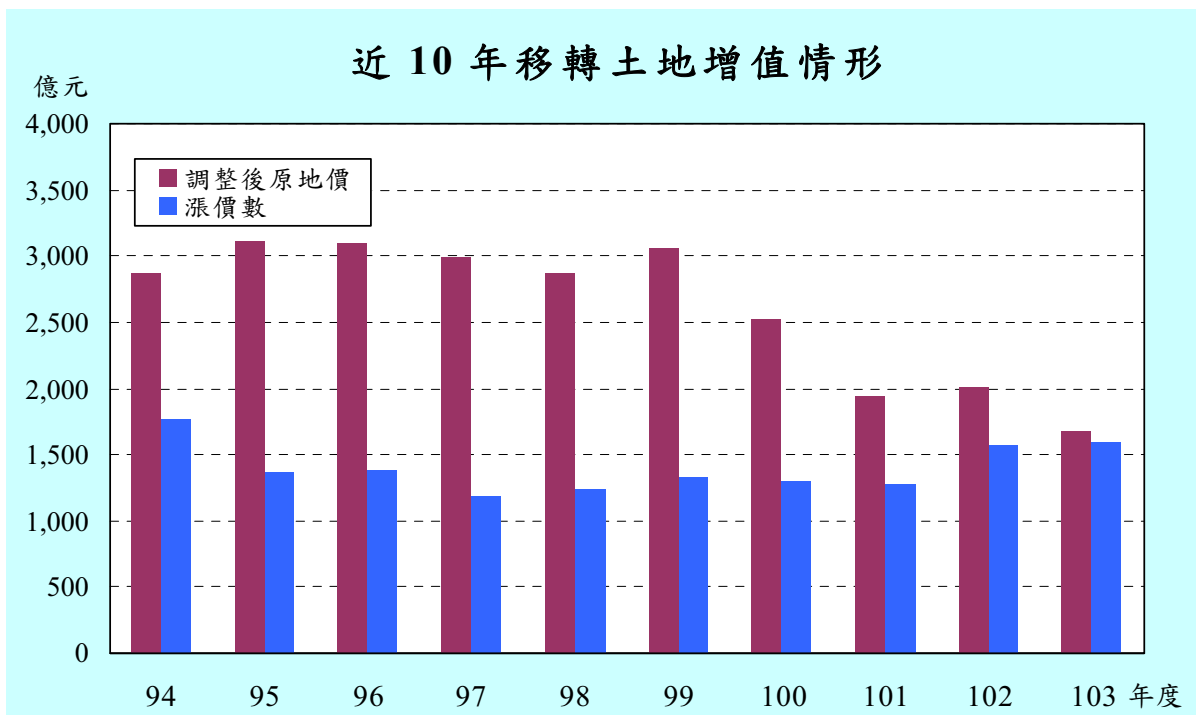
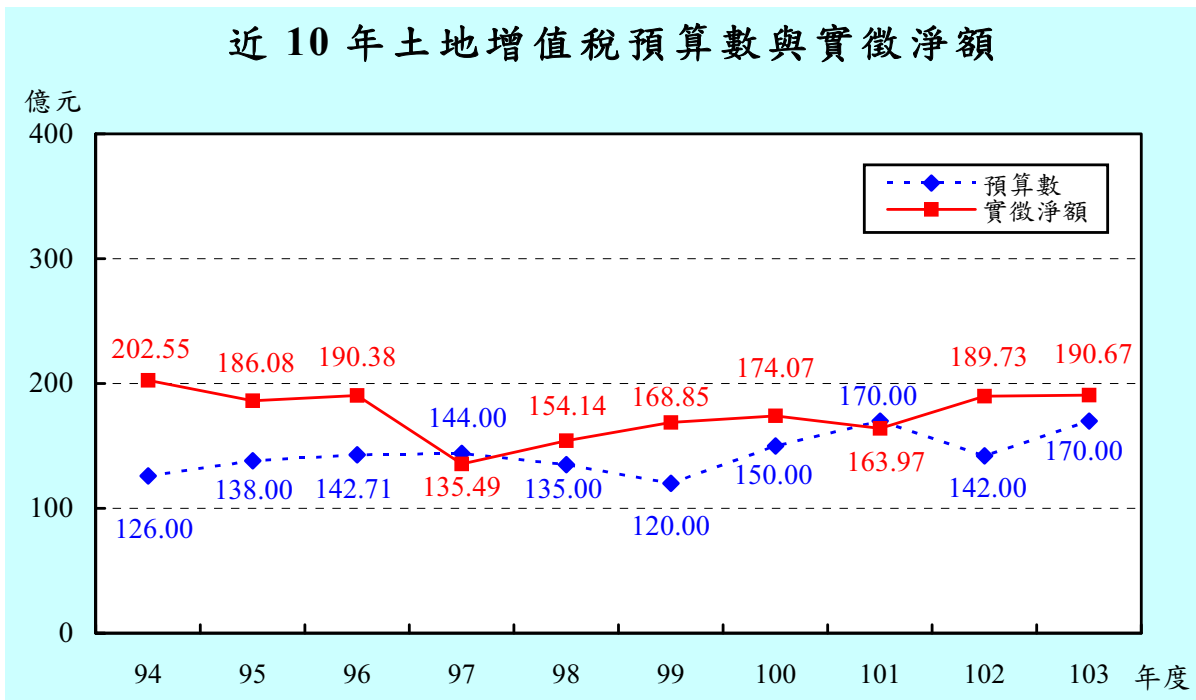

五、房屋稅

103 年度實徵淨額 122.17 億元，與預算數 120 億元比較，增加 2.17 億元，超徵 1.8%；較上年度實徵淨額 119.76 億元增加 2.41 億元，成長 2%。

因 103 年重行評定房屋標準價格與修正本市房屋稅徵收自治條例，提高非自住之其他供住家用房屋稅率及供私人醫院、診所或自由職業事務所使用房屋稅率，致稅基及稅率上升，又加強房屋稅稅籍清查、積極清理欠稅及提高繳款書送達率，使得稅收超徵且較上年度增加。

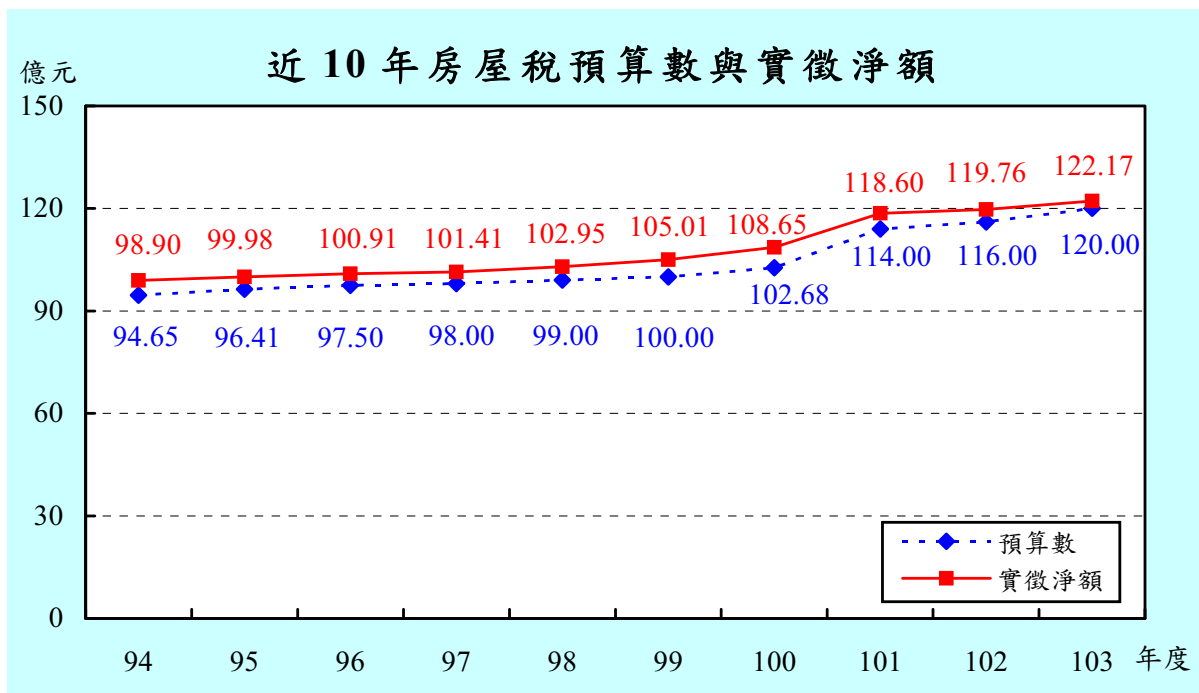

103 年度房屋稅稅源比重(構造別面積)

總計 187,129,628 平方公尺

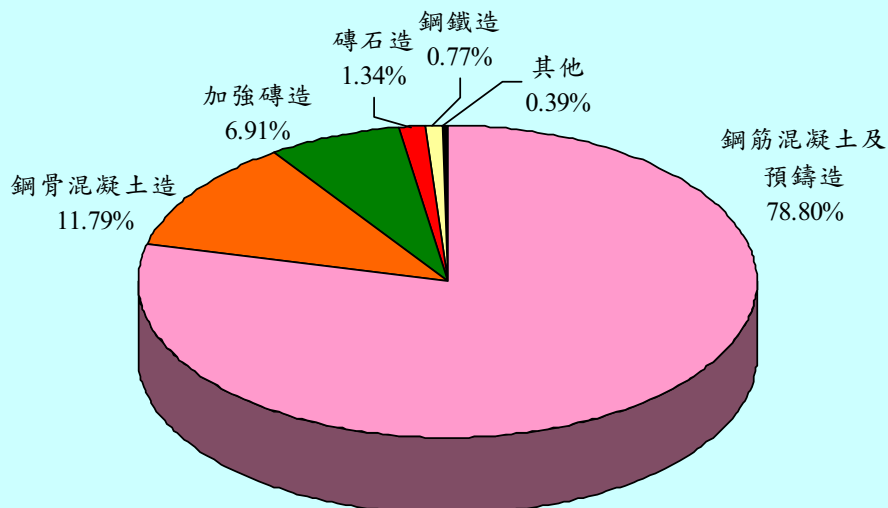

六、使用牌照稅

103 年度實徵淨額 71.14 億元，與預算數 66 億元比較，增加 5.14 億元，超徵 7.8%；較上年度實徵淨額 69.5 億元增加 1.64 億元，成長 2.4%。

103 年度因車輛數增加、積極辦理免稅案件清查及欠稅清理，致稅收超徵且較上年度增加。

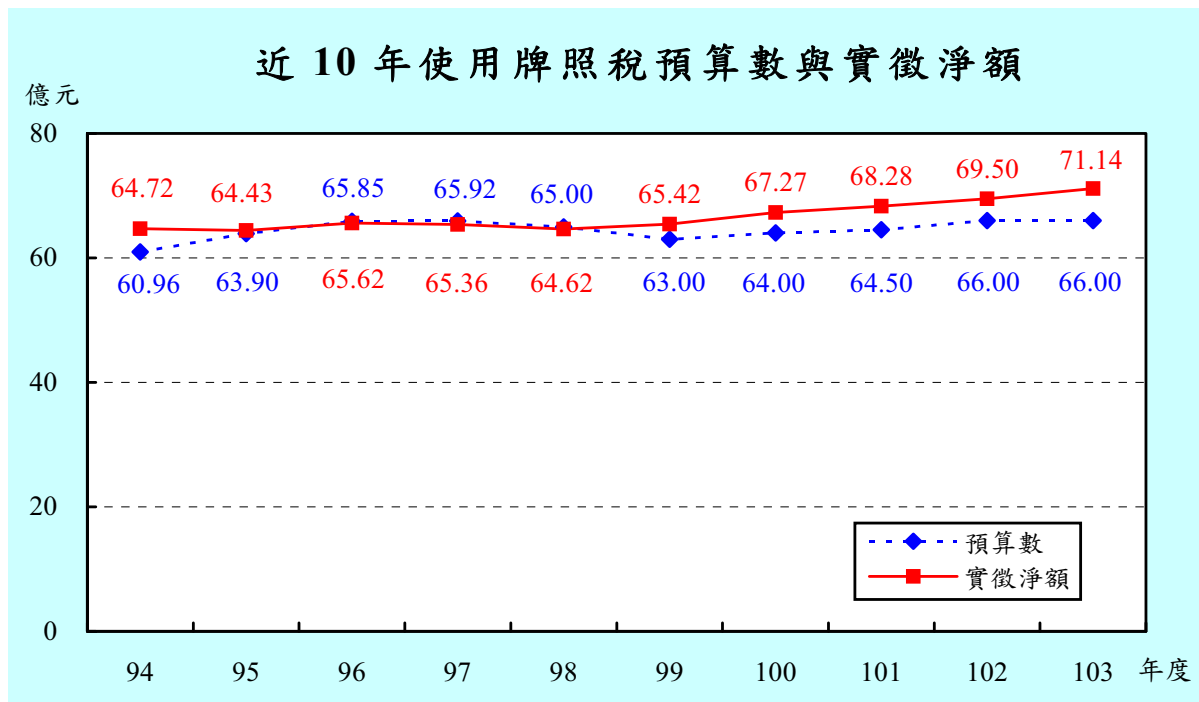

103 年度使用牌照稅稅源比重(車輛別件數)

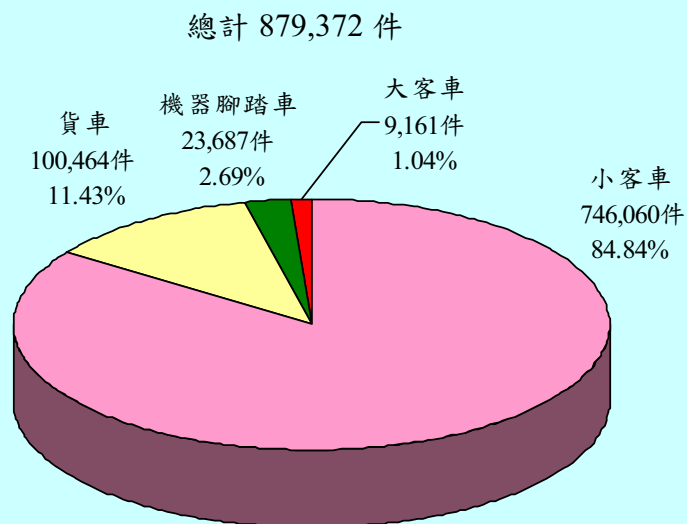

七、契稅

103 年度實徵淨額 16.51 億元，與預算數 18 億元比較，減少 1.49 億元，短徵 8.3%；較上年度實徵淨額 17.15 億元減少 0.64 億元，負成長 3.8%。

103 年契稅稅收因房屋交易市場受特種貨物及勞務稅（奢侈稅）、不動產成交案件實際資訊申報登錄（實價登錄）制度影響而使交易量減少，又因移轉房屋大多屬經歷年數 10 年以上之舊屋，其房屋現值偏低，使得契價偏低，致稅收短徵並較上年度減少。

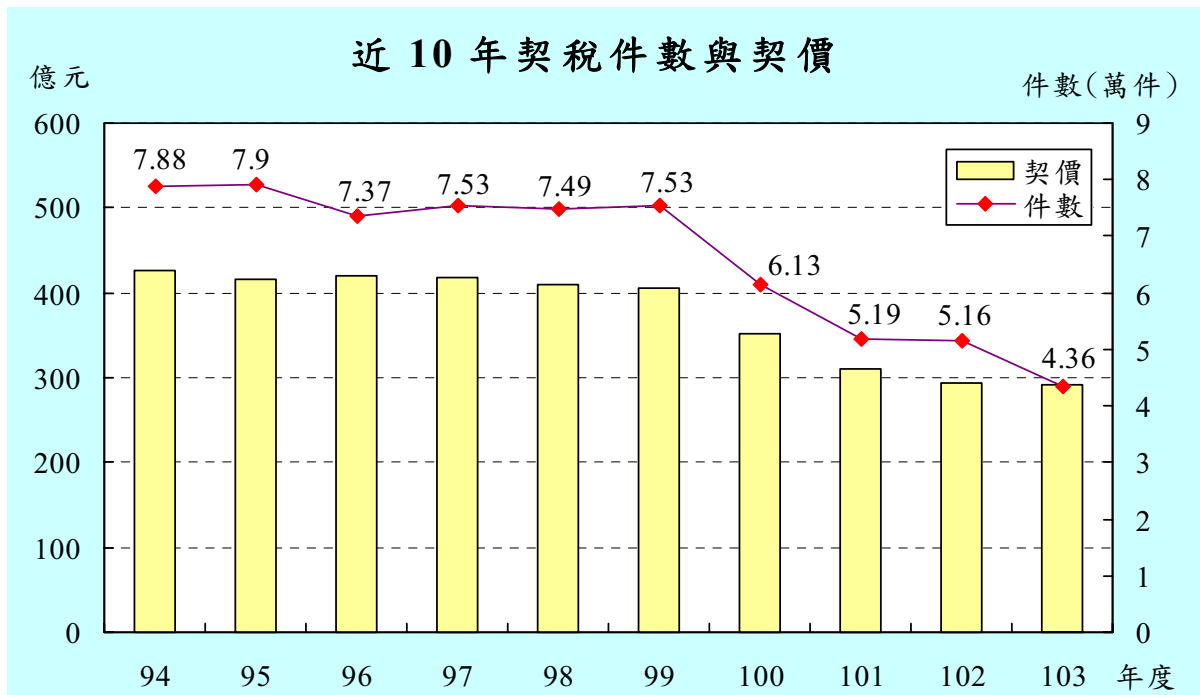
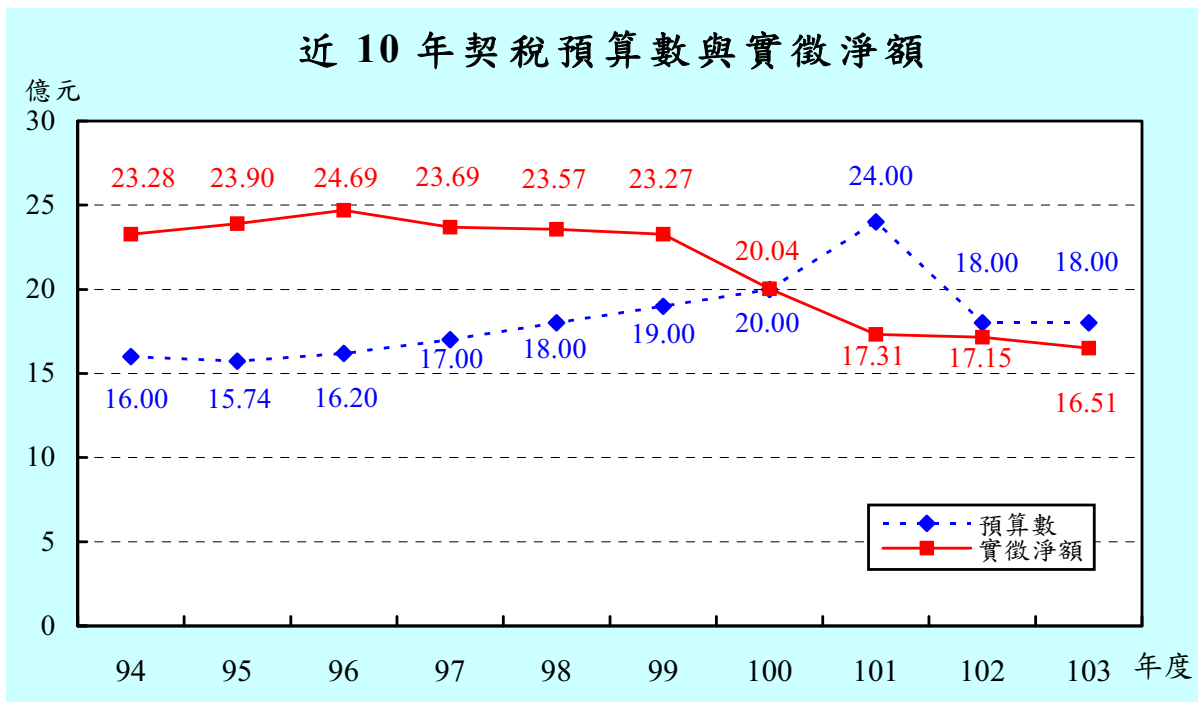

八、印花稅

103 年度實徵淨額 45.59 億元，與預算數 42.6 億元比較，增加 2.99 億元，超徵 7%；較上年度實徵淨額 43.82 億元增加 1.77 億元，成長 4.1%。

103 年度因執行印花稅應稅憑證檢查作業及積極輔導納稅義務人依法繳納印花稅，致稅收超徵且較上年度增加。

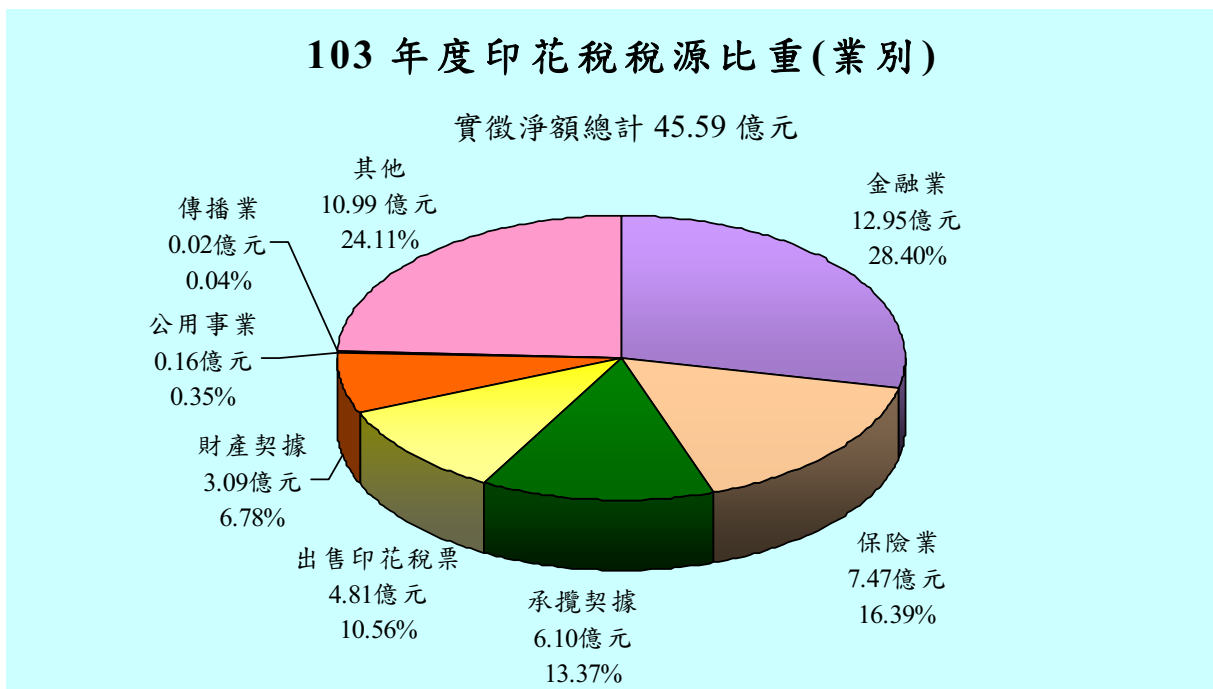
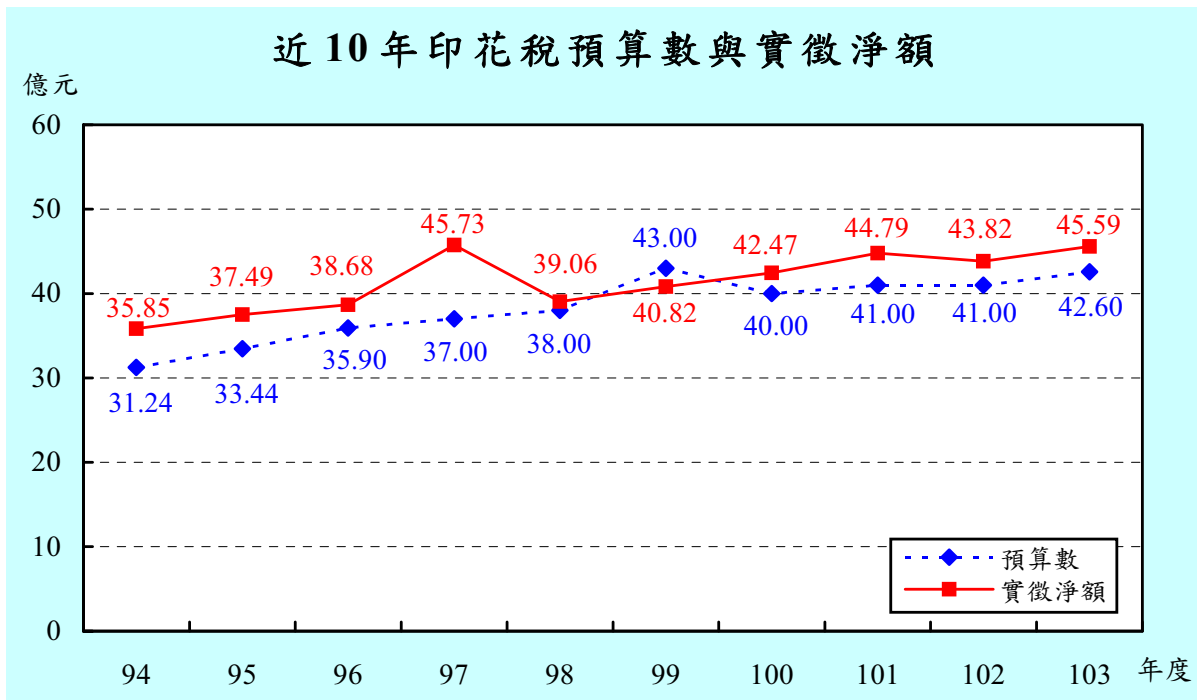

九、娛樂稅

103 年度實徵淨額 2.35 億元，與預算數 2.15 億元比較，增加 0.2 億元，超徵 9.2%；較上年度實徵淨額 2.29 億元增加 0.06 億元，成長 2.6%。

103 年度因舉辦臨時性娛樂表演活動較預期增多，致稅收超徵且較上年度增加。

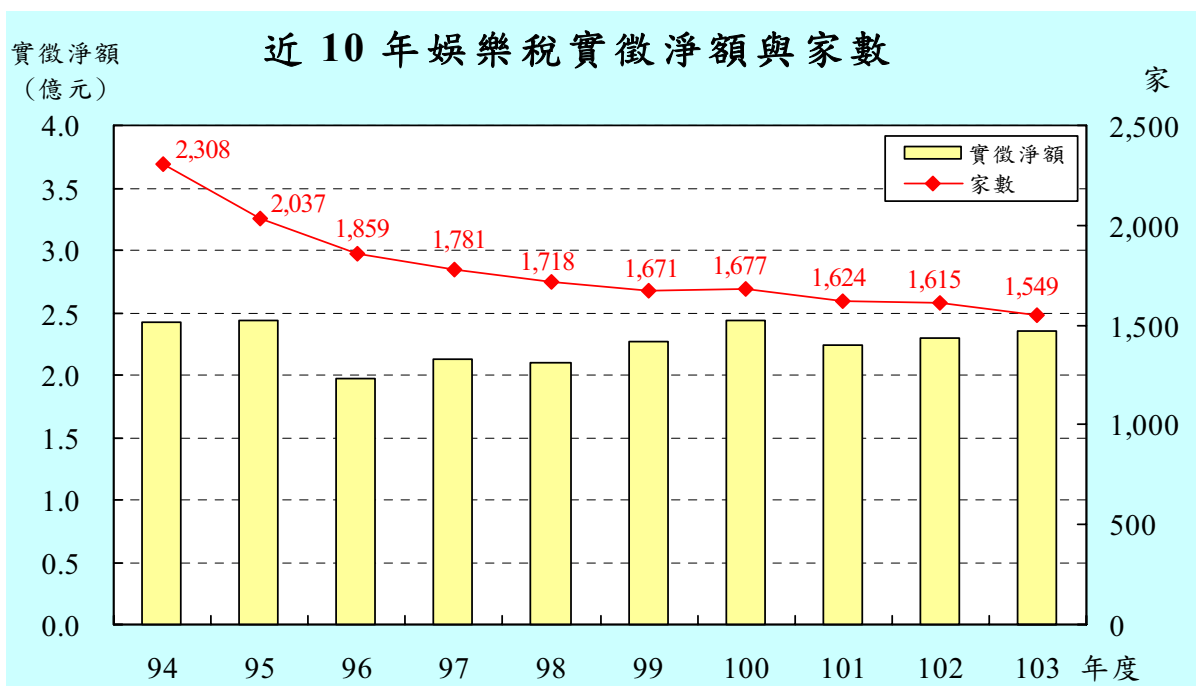
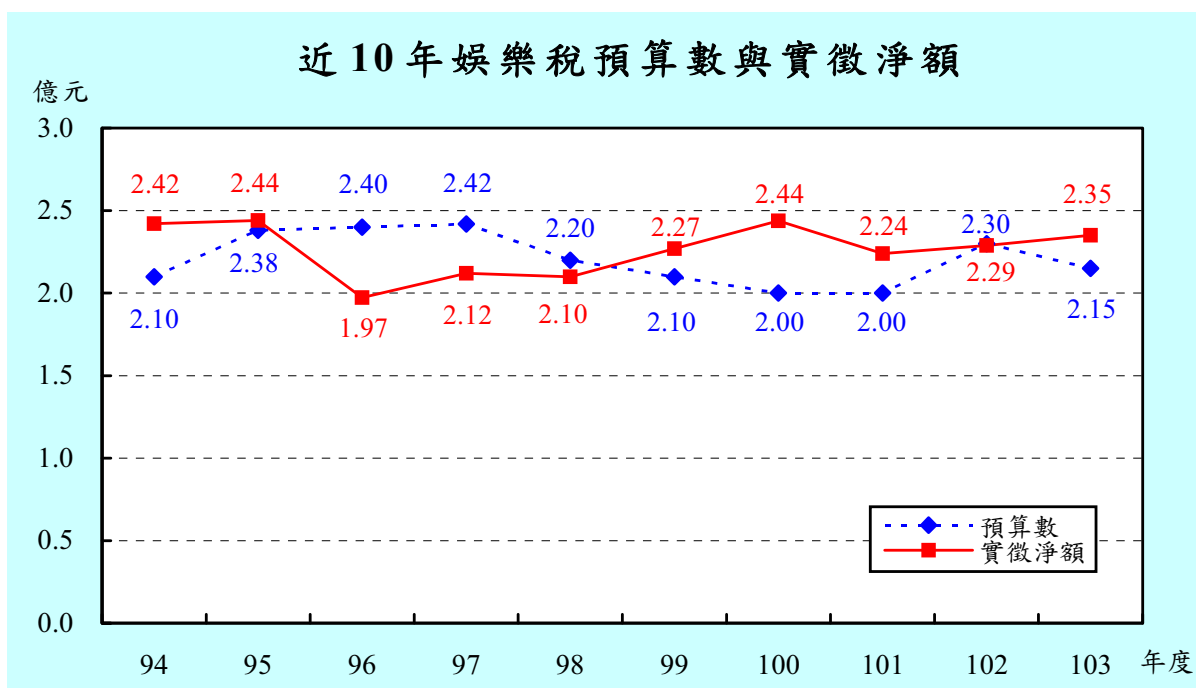

貳、稅收統計

II . Tax Revenue Statistics

表 1 各項稅捐徵績比較

單位：新臺幣千元

稅目別 Item of Tax	103 年 度		FY 2014			
	預算數 Budget Amount	查定數① Audited Amount	實徵數② Actual Collection	退還以前 年度歲入款 Tax Income Returned	實徵淨額 Net Actual Collection	實徵數 占預算數 % Actual Collection/ Budget Amount
總 計 Grand Total	63,179,000	70,613,134	67,721,827	328,817	67,393,010	107.2
稅 課 收 入 Revenues from Taxes	63,075,000	70,184,842	67,616,184	325,059	67,291,124	107.2
地 價 稅 Land Value Tax	21,200,000	23,465,985	22,520,361	72,406	22,447,955	106.2
土 地 增 值 稅 Land Value Increment Tax	17,000,000	20,373,583	19,303,115	236,108	19,067,007	113.5
房 屋 稅 House Tax	12,000,000	12,425,933	12,221,542	4,408	12,217,134	101.8
使 用 牌 照 稅 Vehicle License Tax	6,600,000	7,407,801	7,118,818	4,939	7,113,878	107.9
契 稅 Deed Tax	1,800,000	1,681,135	1,656,050	5,415	1,650,636	92.0
印 花 稅 Stamp Tax	4,260,000	4,582,706	4,561,139	1,543	4,559,596	107.1
娛 樂 稅 Amusement Tax	215,000	247,274	235,078	203	234,875	109.3
教 育 經 費 Education Surtax	—	425	82	39	43	--
工 程 受 益 費 Construction Benefit Fee	—	—	—	—	—	--
罰 鍰 收 入 Punitive Fine Revenue	104,000	428,293	105,644	3,758	101,886	101.6
規 費 收 入 Fees Revenue	—	—	—	—	—	--
契 稅 監 證 費 Fees	—	—	—	—	—	--

資料來源：依據徵課會計報告編製。

附 註：①查定數包括以前年度結轉數。

②實徵數未含實物抵繳稅款(以遞延收入入帳)。

Table 1. Net Tax Revenues Compare

Unit : N.T.\$1,000

實徵淨額 占預算數 % Net Actual Collection/ Budget Amount	103 年度與 102 年度比較 Compare FY2014 with FY2013			102 年度與 101 年度比較 Compare FY2013 with FY2012		
	102 年度 實徵淨額 Net Actual Collection FY 2013	增 減 數 Amount	增 減 %	101 年度 實徵淨額 Net Actual Collection FY2012	增 減 數 Amount	增 減 %
106.7	66,440,531	952,479	1.4	62,306,906	4,133,625	6.6
106.7	66,310,719	980,405	1.5	62,189,138	4,121,581	6.6
105.9	22,086,331	361,624	1.6	20,670,524	1,415,807	6.8
112.2	18,972,794	94,213	0.5	16,397,214	2,575,580	15.7
101.8	11,976,047	241,087	2.0	11,859,935	116,113	1.0
107.8	6,950,094	163,784	2.4	6,827,726	122,368	1.8
91.7	1,714,951	- 64,315	-3.8	1,730,766	- 15,815	-0.9
107.0	4,381,501	178,095	4.1	4,478,571	- 97,071	-2.2
109.2	228,927	5,947	2.6	224,138	4,790	2.1
--	74	- 31	-41.8	264	- 190	-72.1
--	--	--	--	--	--	--
98.0	129,812	- 27,926	-21.5	117,768	12,044	10.2
--	--	--	--	--	--	--
--	--	--	--	--	--	--

表 2 歷年各項稅捐預算數、查定數與實徵數

(一)總計①

單位：新臺幣元

年度(月)別 Fiscal Year (Month)	預算數 Budget Amount (A)	查定數 Audited Amount		
		合計 Total	本年度 Current FY	以前年度② Previous FY
94 年度 FY 2005	49,981,343,000	68,597,652,306	61,005,462,738	7,592,189,568
95 年度 FY 2006	52,011,000,000	66,672,822,287	59,184,231,898	7,488,590,389
96 年度 FY 2007	53,276,009,000	68,462,333,538	62,102,868,839	6,359,464,699
97 年度 FY 2008	54,238,000,000	63,451,419,838	57,508,965,836	5,942,454,002
98 年度 FY 2009	53,721,000,000	62,756,930,153	57,011,890,023	5,745,040,130
99 年度 FY 2010	52,865,000,000	65,873,934,825	61,521,291,170	4,352,643,655
100 年度 FY 2011	56,422,260,000	65,754,247,039	61,847,950,043	3,906,296,996
101 年度 FY 2012	61,185,000,000	65,905,662,486	62,733,494,186	3,172,168,300
102 年度 FY 2013	60,561,000,000	69,598,903,684	66,719,824,179	2,879,079,505
103 年度 FY 2014	63,179,000,000	70,613,134,428	67,876,534,672	2,736,599,756
1 月 Jan.	2,787,446,000	6,090,228,506	3,221,294,211	2,868,934,295
2 月 Feb.	1,460,409,000	1,952,261,719	1,972,144,854	- 19,883,135
3 月 Mar.	2,766,854,000	3,008,492,027	3,016,854,452	- 8,362,425
4 月 Apr.	5,255,542,000	8,283,505,758	8,325,207,841	- 41,702,083
5 月 May	11,635,033,000	14,187,018,321	14,201,125,867	- 14,107,546
6 月 June	5,822,905,000	1,622,680,401	1,630,171,194	- 7,490,793
7 月 July	2,609,125,000	2,473,976,121	2,478,870,042	- 4,893,921
8 月 Aug.	1,601,566,000	1,731,137,605	1,734,708,249	- 3,570,644
9 月 Sep.	2,152,986,000	2,152,058,252	2,164,564,072	- 12,505,820
10 月 Oct.	2,036,308,000	2,538,939,012	2,544,286,304	- 5,347,292
11 月 Nov.	13,743,556,000	24,159,668,134	24,167,067,702	- 7,399,568
12 月 Dec.	11,307,270,000	2,413,168,572	2,420,239,884	- 7,071,312

附註：①總計=稅課收入+工程受益費+罰鍰收入+規費收入(監證費)。

②包括以前年度結轉數。

③99年度起實徵數未含實物抵繳稅款(以遞延收入入帳)。

Table 2. Budget Amount, Audited Amount and Actual Collection
in Recent Years

(I) Grand Total ①

Unit : N.T.\$1

實徵數 Actual Collection ③			退還以前年度 歲入款 Tax Income Returned (4)	實徵淨額 Net Actual Collection (1-4=5)	實徵淨額 占預算數 % Net Actual Collection /Budge Amount (5/A)×100
合計 Total (2+3=1)	本年度 Current FY (2)	以前年度 Previous FY (3)			
60,821,499,933	58,345,872,794	2,475,627,139	278,499,442	60,543,000,491	121.1
59,935,082,828	57,140,304,656	2,794,778,172	375,940,451	59,559,142,377	114.5
62,211,212,658	60,107,595,743	2,103,616,915	330,261,624	61,880,951,034	116.2
57,349,343,608	55,240,378,164	2,108,965,444	595,865,819	56,753,477,789	104.6
57,906,303,509	55,585,418,083	2,320,885,426	408,280,057	57,498,023,452	107.0
61,412,898,686	59,915,978,897	1,496,919,789	507,663,766	60,905,234,920	115.2
62,364,742,945	60,525,743,015	1,838,999,930	205,300,912	62,159,442,033	110.2
62,751,393,789	61,392,970,041	1,358,423,748	444,487,791	62,306,905,998	101.8
66,673,882,137	65,467,820,238	1,206,061,899	233,351,037	66,440,531,100	109.7
67,721,827,234	66,736,988,776	984,838,458	328,817,075	67,393,010,159	106.7
3,074,406,808	2,717,685,879	356,720,929	141,991,967	2,932,414,841	105.2
1,763,487,475	1,630,891,885	132,595,590	23,271,574	1,740,215,901	119.2
3,509,581,295	3,437,708,706	71,872,589	12,808,212	3,496,773,083	126.4
5,770,097,153	5,650,120,055	119,977,098	14,329,381	5,755,767,772	109.5
11,243,148,364	11,181,926,832	61,221,532	20,122,851	11,223,025,513	96.5
6,704,858,908	6,673,883,785	30,975,123	20,087,698	6,684,771,210	114.8
2,402,402,060	2,355,400,022	47,002,038	31,208,380	2,371,193,680	90.9
1,991,412,238	1,952,997,431	38,414,807	7,559,493	1,983,852,745	123.9
2,180,652,708	2,162,821,101	17,831,607	9,863,798	2,170,788,910	100.8
2,505,995,513	2,429,966,559	76,028,954	10,712,637	2,495,282,876	122.5
12,859,768,848	12,845,879,949	13,888,899	18,935,190	12,840,833,658	93.4
13,716,015,864	13,697,706,572	18,309,292	17,925,894	13,698,089,970	121.1

表 2 歷年各項稅捐預算數、查定數與實徵數 (續1)

(二)稅課收入

1. 合計

單位：新臺幣元

年度(月)別 Fiscal Year (Month)	預算數 Budget Amount (A)	查定數 Audited Amount		
		合計 Total	本年度 Current FY	以前年度① Previous FY
94 年度 FY 2005	49,793,343,000	68,132,972,862	60,886,814,259	7,246,158,603
95 年度 FY 2006	51,828,000,000	66,235,324,703	59,111,525,544	7,123,799,159
96 年度 FY 2007	53,093,009,000	68,020,104,766	61,976,402,641	6,043,702,125
97 年度 FY 2008	54,034,000,000	62,976,080,816	57,346,759,662	5,629,321,154
98 年度 FY 2009	53,520,000,000	62,262,066,305	56,854,450,564	5,407,615,741
99 年度 FY 2010	52,710,000,000	65,326,212,670	61,317,097,584	4,009,115,086
100 年度 FY 2011	56,268,260,000	65,190,790,529	61,714,468,538	3,476,321,991
101 年度 FY 2012	61,050,000,000	65,409,563,052	62,634,837,985	2,774,725,067
102 年度 FY 2013	60,430,000,000	69,105,259,084	66,618,323,432	2,486,935,652
103 年度 FY 2014	63,075,000,000	70,184,841,864	67,802,361,337	2,382,480,527
1 月 Jan.	2,779,548,000	5,733,915,981	3,216,343,037	2,517,572,944
2 月 Feb.	1,452,090,000	1,946,318,818	1,966,542,072	- 20,223,254
3 月 Mar.	2,758,754,000	2,999,011,286	3,008,055,483	- 9,044,197
4 月 Apr.	5,245,065,000	8,272,697,198	8,315,136,883	- 42,439,685
5 月 May	11,624,024,000	14,172,626,017	14,186,222,491	- 13,596,474
6 月 June	5,813,540,000	1,612,330,574	1,619,147,717	- 6,817,143
7 月 July	2,599,746,000	2,468,381,992	2,473,991,770	- 5,609,778
8 月 Aug.	1,595,288,000	1,725,888,258	1,731,734,608	- 5,846,350
9 月 Sep.	2,144,572,000	2,151,622,192	2,163,987,058	- 12,364,866
10 月 Oct.	2,030,484,000	2,536,797,251	2,542,402,897	- 5,605,646
11 月 Nov.	13,735,272,000	24,158,005,605	24,163,965,194	- 5,959,589
12 月 Dec.	11,296,617,000	2,407,246,692	2,414,832,127	-7,585,435

附註：①包括以前年度結轉數。

②99年度起實徵數未含實物抵繳稅款(以遞延收入入帳)。

Table 2. Budget Amount, Audited Amount and Actual Collection
in Recent Years (Cont. 1)

(II) Revenues from Taxes

1. Total

Unit : N.T.\$1

實 徵 數 Actual Collection ②		退還以前年度 歲入款 Tax Income Returned (4)	實 徵 淨 額 Net Actual Collection (1-4=5)	實徵淨額 占預算數 % Net Actual Collection /Budge Amount (5/A)×100	
合 計 Total (2+3=1)	本 年 度 Current FY (2)				以 前 年 度 Previous FY (3)
60,597,567,284	58,278,178,350	2,319,388,934	265,326,790	60,332,240,494	121.2
59,704,949,774	57,086,468,516	2,618,481,258	371,162,603	59,333,787,171	114.5
62,019,116,746	60,048,819,696	1,970,297,050	323,317,992	61,695,798,754	116.2
57,157,456,189	55,176,188,981	1,981,267,208	586,921,874	56,570,534,315	104.7
57,706,501,696	55,526,927,616	2,179,574,080	361,017,806	57,345,483,890	107.1
61,246,934,737	59,853,800,575	1,393,134,162	402,019,755	60,844,914,982	115.4
62,176,573,002	60,466,079,308	1,710,493,694	177,305,299	61,999,267,703	110.2
62,620,652,883	61,349,810,533	1,270,842,350	431,514,478	62,189,138,405	101.9
66,530,700,040	65,412,535,691	1,118,164,349	219,980,597	66,310,719,443	109.7
67,616,183,545	66,695,912,290	920,271,255	325,059,274	67,291,124,271	106.7
3,063,397,930	2,715,674,293	347,723,637	140,840,481	2,922,557,449	105.1
1,757,053,228	1,630,268,606	126,784,622	22,262,020	1,734,791,208	119.5
3,499,682,899	3,434,307,399	65,375,500	12,702,717	3,486,980,182	126.4
5,762,622,313	5,648,771,889	113,850,424	14,215,068	5,748,407,245	109.6
11,231,526,603	11,175,680,872	55,845,731	19,841,547	11,211,685,056	96.5
6,694,757,462	6,668,790,718	25,966,744	20,016,170	6,674,741,292	114.8
2,393,102,818	2,352,018,095	41,084,723	31,065,456	2,362,037,362	90.9
1,981,304,422	1,949,109,106	32,195,316	7,405,349	1,973,899,073	123.7
2,175,064,518	2,160,657,378	14,407,140	9,685,276	2,165,379,242	101.0
2,498,226,485	2,427,027,063	71,199,422	10,678,685	2,487,547,800	122.5
12,853,239,370	12,841,868,588	11,370,782	18,596,453	12,834,642,917	93.4
13,706,205,497	13,691,738,283	14,467,214	17,750,052	13,688,455,445	121.2

表 2 歷年各項稅捐預算數、查定數與實徵數 (續2)

(二)稅課收入

2. 地價稅

單位：新臺幣元

年度(月)別 Fiscal Year (Month)	預算數 Budget Amount (A)	查定數 Audited Amount		
		合計 Total	本年度 Current FY	以前年度 Previous FY
94 年度 FY 2005	16,697,695,000	21,023,343,012	17,744,063,944	3,279,279,068
95 年度 FY 2006	16,841,000,000	20,877,369,503	17,631,744,847	3,245,624,656
96 年度 FY 2007	17,037,000,000	22,406,238,656	19,665,335,019	2,740,903,637
97 年度 FY 2008	17,600,000,000	21,622,348,590	18,962,431,757	2,659,916,833
98 年度 FY 2009	17,800,000,000	20,775,773,127	18,637,378,171	2,138,394,956
99 年度 FY 2010	18,000,000,000	22,108,091,007	20,315,591,574	1,792,499,433
100 年度 FY 2011	18,400,000,000	21,729,735,988	20,213,024,931	1,516,711,057
101 年度 FY 2012	19,500,000,000	21,916,615,715	20,793,949,827	1,122,665,888
102 年度 FY 2013	21,900,000,000	23,134,506,730	22,091,728,224	1,042,778,506
103 年度 FY 2014	21,200,000,000	23,465,985,406	22,555,658,532	910,326,874
1 月 Jan.	69,113,000	976,857,742	12,204,132	964,653,610
2 月 Feb.	51,570,000	7,897,140	12,464,235	- 4,567,095
3 月 Mar.	52,872,000	168,805,594	171,476,983	- 2,671,389
4 月 Apr.	158,870,000	144,992,935	174,478,328	- 29,485,393
5 月 May	95,425,000	24,808,678	26,713,172	- 1,904,494
6 月 June	34,137,000	13,606,775	15,721,510	- 2,114,735
7 月 July	15,780,000	12,637,706	14,777,554	- 2,139,848
8 月 Aug.	23,584,000	18,939,067	20,598,083	- 1,659,016
9 月 Sep.	31,917,000	44,907,290	48,119,229	- 3,211,939
10 月 Oct.	433,921,000	222,684,702	223,458,537	- 773,835
11 月 Nov.	11,062,229,000	21,834,568,819	21,833,514,470	1,054,349
12 月 Dec.	9,170,582,000	-4,721,042	2,132,299	- 6,853,341

Table 2. Budget Amount, Audited Amount and Actual Collection
in Recent Years (Cont. 2)

(II) Revenues from Taxes

2. Land Value Tax

Unit : N.T.\$1

實 徵 數 Actual Collection			退還以前年度 歲入款 Tax Income Returned (4)	實徵淨額 Net Actual Collection (1-4=5)	實徵淨額 占預算數 % Net Actual Collection /Budge Amount (5/A)×100
合 計 Total (2+3=1)	本 年 度 Current FY (2)	以 前 年 度 Previous FY (3)			
17,642,901,242	16,674,917,773	967,983,469	85,128,173	17,557,773,069	105.2
17,966,408,173	16,742,406,708	1,224,001,465	65,594,730	17,900,813,443	106.3
19,562,228,351	18,649,206,309	913,022,042	93,531,178	19,468,697,173	114.3
19,336,852,287	18,205,651,270	1,131,201,017	148,458,460	19,188,393,827	109.0
18,836,109,030	18,029,123,615	806,985,415	133,715,429	18,702,393,601	105.1
20,332,765,697	19,623,815,795	708,949,902	41,724,158	20,291,041,539	112.7
20,534,137,009	19,743,790,367	790,346,642	28,928,504	20,505,208,505	111.4
20,748,021,644	20,243,111,064	504,910,580	77,497,739	20,670,523,905	106.0
22,143,481,947	21,644,233,803	499,248,144	57,150,883	22,086,331,064	100.9
22,520,360,611	22,125,335,251	395,025,360	72,405,760	22,447,954,851	105.9
98,931,330	8,941,499	89,989,831	33,162,370	65,768,960	95.2
45,234,944	4,578,296	40,656,648	6,365,165	38,869,779	75.4
194,187,719	164,816,436	29,371,283	2,911,871	191,275,848	361.8
266,131,923	178,582,462	87,549,461	185,805	265,946,118	167.4
50,579,470	15,526,044	35,053,426	4,586,660	45,992,810	48.2
38,038,704	23,198,176	14,840,528	671,669	37,367,035	109.5
26,697,096	8,752,370	17,944,726	7,283,572	19,413,524	123.0
27,342,282	10,167,819	17,174,463	551,366	26,790,916	113.6
17,059,910	10,710,030	6,349,880	1,341,897	15,718,013	49.2
283,483,817	243,842,486	39,641,331	1,037,899	282,445,918	65.1
10,311,670,611	10,304,755,680	6,914,931	12,177,292	10,299,493,319	93.1
11,161,002,805	11,151,463,953	9,538,852	2,130,194	11,158,872,611	121.7

表 2 歷年各項稅捐預算數、查定數與實徵數 (續3)

(二)稅課收入

3. 土地增值稅

單位：新臺幣元

年度(月)別 Fiscal Year (Month)	預算數 Budget Amount (A)	查定數 Audited Amount		
		合計 Total	本年度 Current FY	以前年度 Previous FY
94 年度 FY 2005	12,600,000,000	22,419,548,012	20,699,450,225	1,720,097,787
95 年度 FY 2006	13,800,000,000	20,479,966,834	18,573,005,660	1,906,961,174
96 年度 FY 2007	14,271,009,000	20,581,406,339	19,082,471,654	1,498,934,685
97 年度 FY 2008	14,400,000,000	15,838,196,306	14,501,930,736	1,336,265,570
98 年度 FY 2009	13,500,000,000	16,754,143,332	14,953,917,653	1,800,225,679
99 年度 FY 2010	12,000,000,000	18,231,273,864	17,212,755,478	1,018,518,386
100 年度 FY 2011	15,000,000,000	18,530,330,855	17,550,051,311	980,279,544
101 年度 FY 2012	17,000,000,000	17,566,789,041	16,633,841,191	932,947,850
102 年度 FY 2013	14,200,000,000	20,013,739,423	19,214,772,442	798,966,981
103 年度 FY 2014	17,000,000,000	20,373,582,528	19,505,216,701	868,365,827
1 月 Jan.	1,759,500,000	3,143,547,164	2,253,642,826	889,904,338
2 月 Feb.	1,084,600,000	1,518,665,044	1,530,356,194	- 11,691,150
3 月 Mar.	1,635,400,000	1,740,235,367	1,741,667,933	- 1,432,566
4 月 Apr.	1,200,200,000	1,439,421,353	1,447,587,568	- 8,166,215
5 月 May	1,348,100,000	1,736,691,262	1,740,189,267	- 3,498,005
6 月 June	1,366,800,000	1,332,300,559	1,332,184,647	115,912
7 月 July	1,603,100,000	1,610,968,213	1,609,905,087	1,063,126
8 月 Aug.	1,157,700,000	1,420,407,542	1,420,407,542	—
9 月 Sep.	1,293,700,000	1,336,725,399	1,336,725,399	—
10 月 Oct.	1,181,500,000	1,642,519,698	1,643,431,653	- 911,955
11 月 Nov.	1,616,700,000	1,428,710,423	1,428,798,058	- 87,635
12 月 Dec.	1,752,700,000	2,023,390,504	2,020,320,527	3,069,977

附註：1、91年2月1日至94年1月31日止土地增值稅減半徵收3年。

2、自94年2月1日起一般用地稅率調降為20%、30%、40%。

Table 2. Budget Amount, Audited Amount and Actual Collection
in Recent Years (Cont. 3)

(II) Revenues from Taxes

3. Land Value Increment Tax

Unit : N.T.\$1

實徵數 Actual Collection			退還以前年度 歲入款 Tax Income Returned (4)	實徵淨額 Net Actual Collection (1-4=5)	實徵淨額 占預算數 % Net Actual Collection /Budge Amount (5/A)×100
合計 Total (2+3=1)	本年度 Current FY (2)	以前年度 Previous FY (3)			
20,417,762,328	19,665,600,010	752,162,318	162,801,073	20,254,961,255	160.8
18,880,808,661	17,906,518,152	974,290,509	272,719,849	18,608,088,812	134.8
19,209,882,958	18,552,463,723	657,419,235	172,100,151	19,037,782,807	133.4
13,943,736,263	13,477,042,093	466,694,170	394,326,670	13,549,409,593	94.1
15,609,940,194	14,555,621,276	1,054,318,918	196,024,352	15,413,915,842	114.2
17,088,982,865	16,718,462,793	370,520,072	204,092,581	16,884,890,284	140.7
17,528,534,334	16,992,903,207	535,631,127	121,268,101	17,407,266,233	116.0
16,674,777,843	16,137,848,941	536,928,902	277,563,791	16,397,214,052	96.5
19,103,840,213	18,728,768,054	375,072,159	131,046,359	18,972,793,854	133.6
19,303,115,028	19,066,215,194	236,899,834	236,107,832	19,067,007,196	112.2
1,971,794,596	1,818,093,022	153,701,574	101,186,278	1,870,608,318	106.3
1,323,773,870	1,312,268,788	11,505,082	14,832,685	1,308,941,185	120.7
2,105,930,464	2,083,291,034	22,639,430	9,395,215	2,096,535,249	128.2
1,411,130,600	1,397,070,773	14,059,827	11,493,384	1,399,637,216	116.6
1,724,823,220	1,713,918,922	10,904,298	13,966,965	1,710,856,255	126.9
1,358,323,201	1,355,050,922	3,272,279	18,818,291	1,339,504,910	98.0
1,361,660,691	1,350,131,303	11,529,388	21,425,631	1,340,235,060	83.6
1,563,688,932	1,560,996,413	2,692,519	6,398,069	1,557,290,863	134.5
1,312,111,411	1,308,974,782	3,136,629	7,807,582	1,304,303,829	100.8
1,684,051,735	1,682,274,697	1,777,038	9,380,623	1,674,671,112	141.7
1,385,363,158	1,384,214,917	1,148,241	6,170,903	1,379,192,255	85.3
2,100,463,150	2,099,929,621	533,529	15,232,206	2,085,230,944	119.0

表 2 歷年各項稅捐預算數、查定數與實徵數 (續4)

(二)稅課收入

4. 房屋稅

單位：新臺幣元

年度(月)別 Fiscal Year (Month)	預算數 Budget Amount (A)	查定數 Audited Amount		
		合計 Total	本年度 Current FY	以前年度 Previous FY
94 年度 FY 2005	9,465,383,000	10,990,080,178	9,728,720,000	1,261,360,178
95 年度 FY 2006	9,641,000,000	11,066,349,485	9,998,789,101	1,067,560,384
96 年度 FY 2007	9,750,000,000	11,110,055,367	10,093,474,972	1,016,580,395
97 年度 FY 2008	9,800,000,000	11,078,405,809	10,126,254,227	952,151,582
98 年度 FY 2009	9,900,000,000	11,165,748,863	10,287,985,782	877,763,081
99 年度 FY 2010	10,000,000,000	11,216,744,220	10,584,535,806	632,208,414
100 年度 FY 2011	10,268,260,000	11,195,589,644	10,724,497,031	471,092,613
101 年度 FY 2012	11,400,000,000	12,145,931,799	11,853,364,805	292,566,994
102 年度 FY 2013	11,600,000,000	12,242,328,975	11,981,068,357	261,260,618
103 年度 FY 2014	12,000,000,000	12,425,932,774	12,183,993,065	241,939,709
1 月 Jan.	34,985,000	263,008,198	17,720,139	245,288,059
2 月 Feb.	26,032,000	36,393,973	36,757,061	- 363,088
3 月 Mar.	17,336,000	34,027,698	34,183,899	- 156,201
4 月 Apr.	381,167,000	373,856,619	374,378,923	- 522,304
5 月 May	7,204,852,000	11,633,282,351	11,633,588,404	- 306,053
6 月 June	4,064,521,000	5,343,381	5,378,794	- 35,413
7 月 July	55,512,000	-71,429	683,872	- 755,301
8 月 Aug.	26,794,000	6,015,605	7,716,159	- 1,700,554
9 月 Sep.	26,798,000	7,172,937	7,267,644	- 94,707
10 月 Oct.	45,528,000	13,417,845	12,732,487	685,358
11 月 Nov.	66,806,000	26,018,331	26,056,411	- 38,080
12 月 Dec.	49,669,000	27,467,265	27,529,272	- 62,007

Table 2. Budget Amount, Audited Amount and Actual Collection
in Recent Years (Cont. 4)

(II) Revenues from Taxes

4. House Tax

Unit : N.T.\$1

實徵數 Actual Collection			退還以前年度 歲入款 Tax Income Returned (4)	實徵淨額 Net Actual Collection (1-4=5)	實徵淨額 占預算數 % Net Actual Collection /Budge Amount (5/A)×100
合計 Total (2+3=1)	本年度 Current FY (2)	以前年度 Previous FY (3)			
9,897,451,617	9,511,123,127	386,328,490	7,244,799	9,890,206,818	104.5
10,008,945,199	9,801,976,281	206,968,918	11,239,378	9,997,705,821	103.7
10,107,330,035	9,936,615,687	170,714,348	16,058,978	10,091,271,057	103.5
10,147,929,725	9,971,769,272	176,160,453	7,309,474	10,140,620,251	103.5
10,307,459,162	10,167,653,129	139,806,033	11,972,825	10,295,486,337	104.0
10,627,295,631	10,486,926,494	140,369,137	126,758,102	10,500,537,529	105.0
10,873,867,433	10,640,949,149	232,918,284	8,744,070	10,865,123,363	105.8
11,869,544,305	11,765,750,542	103,793,763	9,609,521	11,859,934,784	104.0
11,997,380,436	11,884,758,971	112,621,465	21,333,121	11,976,047,315	103.2
12,221,541,822	12,093,853,815	127,688,007	4,407,746	12,217,134,076	101.8
23,030,989	12,755,366	10,275,623	278,678	22,752,311	65.0
76,058,447	12,596,655	63,461,792	453,461	75,604,986	290.4
36,427,257	32,812,928	3,614,329	39,527	36,387,730	209.9
379,576,887	375,934,567	3,642,320	182,349	379,394,538	99.5
6,424,317,863	6,422,037,703	2,280,160	910,419	6,423,407,444	89.2
4,969,137,616	4,966,737,780	2,399,836	317,414	4,968,820,202	122.2
62,928,366	58,328,369	4,599,997	1,584,568	61,343,798	110.5
45,616,466	37,832,592	7,783,874	139,795	45,476,671	169.7
39,326,864	37,766,460	1,560,404	240,395	39,086,469	145.9
93,760,972	67,683,174	26,077,798	34,463	93,726,509	205.9
37,799,324	37,212,509	586,815	159,462	37,639,862	56.3
33,560,771	32,155,712	1,405,059	67,215	33,493,556	67.4

表 2 歷年各項稅捐預算數、查定數與實徵數 (續5)

(二)稅課收入

5. 使用牌照稅

單位：新臺幣元

年度(月)別 Fiscal Year (Month)	預算數 Budget Amount (A)	查定數 Audited Amount		
		合計 Total	本年度 Current FY	以前年度 Previous FY
94 年度 FY 2005	6,096,208,000	7,375,409,176	6,508,892,037	866,517,139
95 年度 FY 2006	6,390,000,000	7,279,956,795	6,501,992,897	777,963,898
96 年度 FY 2007	6,585,000,000	7,236,551,078	6,569,504,486	667,046,592
97 年度 FY 2008	6,592,000,000	7,146,127,212	6,566,865,409	579,261,803
98 年度 FY 2009	6,500,000,000	7,003,421,917	6,486,376,074	517,045,843
99 年度 FY 2010	6,300,000,000	7,057,513,192	6,557,727,685	499,785,507
100 年度 FY 2011	6,400,000,000	7,172,227,550	6,720,258,884	451,968,666
101 年度 FY 2012	6,450,000,000	7,210,013,827	6,833,694,476	376,319,351
102 年度 FY 2013	6,600,000,000	7,286,652,627	6,966,480,016	320,172,611
103 年度 FY 2014	6,600,000,000	7,407,801,179	7,137,466,677	270,334,502
1 月 Jan.	115,331,000	454,494,059	131,877,890	322,616,169
2 月 Feb.	76,264,000	71,051,414	73,372,178	- 2,320,764
3 月 Mar.	310,884,000	372,784,558	376,900,129	- 4,115,571
4 月 Apr.	3,243,148,000	6,074,887,700	6,078,871,362	- 3,983,662
5 月 May	2,181,947,000	32,870,407	40,537,128	- 7,666,721
6 月 June	73,484,000	7,009,892	11,574,254	- 4,564,362
7 月 July	98,791,000	28,355,258	31,900,887	- 3,545,629
8 月 Aug.	81,946,000	9,786,478	12,084,394	- 2,297,916
9 月 Sep.	38,104,000	8,769,151	17,720,176	- 8,951,025
10 月 Oct.	119,791,000	349,028,683	353,370,853	- 4,342,170
11 月 Nov.	240,576,000	2,066,718	8,821,817	- 6,755,099
12 月 Dec.	19,734,000	-3,303,139	435,609	- 3,738,748

附註：計程車客運業自94年12月2日起免徵使用牌照稅。

Table 2. Budget Amount, Audited Amount and Actual Collection
in Recent Years (Cont. 5)

(II) Revenues from Taxes

5. Vehicle License Tax

Unit : N.T.\$1

實徵數 Actual Collection			退還以前年度 歲入款 Tax Income Returned (4)	實徵淨額 Net Actual Collection (1-4=5)	實徵淨額 占預算數 % Net Actual Collection /Budge Amount (5/A)×100
合計 Total (2+3=1)	本年度 Current FY (2)	以前年度 Previous FY (3)			
6,475,038,293	6,288,700,519	186,337,774	3,521,817	6,471,516,476	106.2
6,456,855,906	6,282,770,037	174,085,869	14,106,973	6,442,748,933	100.8
6,570,266,092	6,387,577,512	182,688,580	8,119,825	6,562,146,267	99.7
6,557,721,371	6,391,932,046	165,789,325	21,283,375	6,536,437,996	99.2
6,471,544,379	6,327,495,599	144,048,780	9,534,915	6,462,009,464	99.4
6,555,896,936	6,423,796,664	132,100,272	13,827,036	6,542,069,900	103.8
6,734,678,663	6,623,516,937	111,161,726	7,912,188	6,726,766,475	105.1
6,833,177,948	6,746,233,733	86,944,215	5,451,652	6,827,726,296	105.9
6,955,441,436	6,877,052,975	78,388,461	5,347,283	6,950,094,153	105.3
7,118,817,681	7,040,294,793	78,522,888	4,939,003	7,113,878,678	107.8
133,087,828	118,091,003	14,996,825	2,809,731	130,278,097	113.0
81,910,229	72,473,552	9,436,677	449,661	81,460,568	106.8
388,291,478	378,584,183	9,707,295	255,285	388,036,193	124.8
3,478,842,437	3,470,623,567	8,218,870	524,383	3,478,318,054	107.3
2,283,316,538	2,275,800,396	7,516,142	203,693	2,283,112,845	104.6
80,720,361	75,355,627	5,364,734	60,720	80,659,641	109.8
118,169,367	111,194,928	6,974,439	82,519	118,086,848	119.5
76,968,188	72,619,914	4,348,274	237,520	76,730,668	93.6
45,601,557	42,556,814	3,044,743	43,087	45,558,470	119.6
130,777,554	127,133,690	3,643,864	64,800	130,712,754	109.1
277,643,750	275,093,737	2,550,013	82,730	277,561,020	115.4
23,488,394	20,767,382	2,721,012	124,874	23,363,520	118.4

表 2 歷年各項稅捐預算數、查定數與實徵數 (續6)

(二)稅課收入

6. 契稅

單位：新臺幣元

年度(月)別 Fiscal Year (Month)	預算數 Budget Amount (A)	查定數 Audited Amount		
		合計 Total	本年度 Current FY	以前年度 Previous FY
94 年度 FY 2005	1,600,000,000	2,370,146,499	2,343,929,540	26,216,959
95 年度 FY 2006	1,574,000,000	2,437,482,207	2,404,929,193	32,553,014
96 年度 FY 2007	1,620,000,000	2,505,084,139	2,471,335,039	33,749,100
97 年度 FY 2008	1,700,000,000	2,400,691,064	2,376,222,441	24,468,623
98 年度 FY 2009	1,800,000,000	2,387,423,390	2,370,494,063	16,929,327
99 年度 FY 2010	1,900,000,000	2,354,950,169	2,335,370,733	19,579,436
100 年度 FY 2011	2,000,000,000	2,024,703,077	2,004,885,156	19,817,921
101 年度 FY 2012	2,400,000,000	1,801,127,687	1,789,084,593	12,043,094
102 年度 FY 2013	1,800,000,000	1,734,852,208	1,715,325,749	19,526,459
103 年度 FY 2014	1,800,000,000	1,681,135,183	1,666,281,819	14,853,364
1 月 Jan.	182,586,000	155,977,557	140,347,271	15,630,286
2 月 Feb.	117,241,000	148,953,277	149,195,485	- 242,208
3 月 Mar.	157,047,000	85,336,654	85,802,193	- 465,539
4 月 Apr.	139,186,000	124,925,473	124,925,473	—
5 月 May	146,619,000	107,089,682	107,089,682	—
6 月 June	139,688,000	104,499,678	104,499,678	—
7 月 July	169,250,000	103,378,452	103,360,858	17,594
8 月 Aug.	158,889,000	113,410,805	113,410,805	—
9 月 Sep.	125,219,000	94,521,863	94,521,863	—
10 月 Oct.	137,464,000	170,563,808	170,594,225	- 30,417
11 月 Nov.	158,211,000	242,885,121	242,885,121	—
12 月 Dec.	168,600,000	229,592,813	229,649,165	- 56,352

Table 2. Budget Amount, Audited Amount and Actual Collection
in Recent Years (Cont. 6)

(II) Revenues from Taxes

6.Deed Tax

Unit : N.T.\$1

實 徵 數 Actual Collection			退還以前年度 歲入款 Tax Income Returned (4)	實徵淨額 Net Actual Collection (1-4=5)	實徵淨額 占預算數 % Net Actual Collection /Budge Amount (5/A)×100
合 計 Total (2+3=1)	本 年 度 Current FY (2)	以 前 年 度 Previous FY (3)			
2,331,208,817	2,314,331,866	16,876,951	3,072,424	2,328,136,393	145.5
2,395,511,426	2,372,214,627	23,296,799	5,651,175	2,389,860,251	151.8
2,482,531,926	2,455,891,723	26,640,203	13,565,211	2,468,966,715	152.4
2,373,419,350	2,355,450,922	17,968,428	4,332,477	2,369,086,873	139.4
2,362,740,281	2,349,557,652	13,182,629	5,738,532	2,357,001,749	130.9
2,331,574,422	2,314,250,777	17,323,645	4,427,193	2,327,147,229	122.5
2,009,354,997	1,990,445,604	18,909,393	5,023,858	2,004,331,139	100.2
1,779,320,448	1,767,832,856	11,487,592	48,554,638	1,730,765,810	72.1
1,718,308,296	1,699,547,000	18,761,296	3,357,047	1,714,951,249	95.3
1,656,050,355	1,641,731,846	14,318,509	5,414,521	1,650,635,834	91.7
131,496,942	117,609,349	13,887,593	3,238,596	128,258,346	70.2
95,537,113	95,083,630	453,483	147,926	95,389,187	81.4
147,943,398	148,199,743	- 256,345	100,120	147,843,278	94.1
118,677,844	118,484,482	193,362	633,468	118,044,376	84.8
109,828,084	109,813,953	14,131	166,460	109,661,624	74.8
99,118,701	99,118,701	—	148,076	98,970,625	70.9
112,652,165	112,652,165	—	507,572	112,144,593	66.3
101,888,922	101,868,669	20,253	76,623	101,812,299	64.1
106,667,477	106,606,221	61,256	184,781	106,482,696	85.0
167,743,340	167,743,340	—	49,738	167,693,602	122.0
210,482,115	210,480,987	1,128	6,066	210,476,049	133.0
254,014,254	254,070,606	- 56,352	155,095	253,859,159	150.6

表 2 歷年各項稅捐預算數、查定數與實徵數 (續7)

(二)稅課收入

7. 印花稅

單位：新臺幣元

年度(月)別 Fiscal Year (Month)	預算數 Budget Amount (A)	查定數 Audited Amount		
		合計 Total	本年度 Current FY	以前年度 Previous FY
94 年度 FY 2005	3,124,057,000	3,622,353,250	3,615,572,362	6,780,888
95 年度 FY 2006	3,344,000,000	3,766,379,307	3,755,601,122	10,778,185
96 年度 FY 2007	3,590,000,000	3,888,454,981	3,873,555,888	14,899,093
97 年度 FY 2008	3,700,000,000	4,609,282,181	4,588,774,708	20,507,473
98 年度 FY 2009	3,800,000,000	3,925,051,668	3,906,121,491	18,930,177
99 年度 FY 2010	4,300,000,000	4,104,312,940	4,082,135,308	22,177,632
100 年度 FY 2011	4,000,000,000	4,276,000,815	4,256,320,858	19,679,957
101 年度 FY 2012	4,100,000,000	4,528,289,507	4,503,633,420	24,656,087
102 年度 FY 2013	4,100,000,000	4,450,816,446	4,420,195,497	30,620,949
103 年度 FY 2014	4,260,000,000	4,582,705,985	4,517,168,088	65,537,897
1 月 Jan.	600,638,000	708,572,891	642,200,484	66,372,407
2 月 Feb.	81,682,000	138,419,652	139,357,723	- 938,071
3 月 Mar.	566,868,000	581,059,770	581,192,515	- 132,745
4 月 Apr.	103,409,000	96,865,326	96,922,849	- 57,523
5 月 May	628,259,000	620,512,989	620,505,219	7,770
6 月 June	117,298,000	132,258,128	132,258,041	87
7 月 July	634,512,000	689,663,667	689,663,667	—
8 月 Aug.	123,731,000	136,014,203	135,888,264	125,939
9 月 Sep.	609,261,000	637,421,111	637,408,835	12,276
10 月 Oct.	96,181,000	123,717,971	123,723,869	- 5,898
11 月 Nov.	577,307,000	601,598,276	601,596,002	2,274
12 月 Dec.	120,854,000	116,602,001	116,450,620	151,381

Table 2. Budget Amount, Audited Amount and Actual Collection
in Recent Years (Cont. 7)

(II) Revenues from Taxes

7. Stamp Tax

Unit : N.T.\$1

實 徵 數 Actual Collection			退還以前年度 歲入款 Tax Income Returned (4)	實徵淨額 Net Actual Collection (1-4=5)	實徵淨額 占預算數 % Net Actual Collection /Budge Amount (5/A)×100
合 計 Total (2+3=1)	本 年 度 Current FY (2)	以 前 年 度 Previous FY (3)			
3,588,199,738	3,585,960,872	2,238,866	3,545,063	3,584,654,675	114.7
3,751,018,926	3,741,648,032	9,370,894	1,713,858	3,749,305,068	112.1
3,868,754,971	3,854,892,522	13,862,449	437,622	3,868,317,349	107.8
4,575,045,907	4,555,749,565	19,296,342	1,704,717	4,573,341,190	123.6
3,908,255,404	3,890,354,445	17,900,959	2,724,686	3,905,530,718	102.8
4,082,809,119	4,061,562,012	21,247,107	492,895	4,082,316,224	94.9
4,251,545,414	4,232,189,023	19,356,391	4,783,867	4,246,761,547	106.2
4,490,891,015	4,466,449,592	24,441,423	12,319,234	4,478,571,781	109.2
4,383,222,779	4,352,816,494	30,406,285	1,721,851	4,381,500,928	106.9
4,561,138,863	4,495,847,841	65,291,022	1,542,838	4,559,596,025	107.0
686,660,071	622,808,337	63,851,734	105,734	686,554,337	114.3
110,111,596	109,151,344	960,252	5,995	110,105,601	134.8
611,038,095	610,973,027	65,068	697	611,037,398	107.8
88,803,197	88,800,129	3,068	1,192,388	87,610,809	84.7
622,278,570	622,270,800	7,770	270	622,278,300	99.0
130,853,673	130,845,899	7,774	—	130,853,673	111.6
687,683,555	687,683,555	—	181,594	687,501,961	108.4
145,208,477	145,082,538	125,939	—	145,208,477	117.4
631,566,712	631,560,334	6,378	—	631,566,712	103.7
124,411,435	124,411,435	—	16,225	124,395,210	129.3
607,482,390	607,482,390	—	—	607,482,390	105.2
115,041,092	114,778,053	263,039	39,935	115,001,157	95.2

表 2 歷年各項稅捐預算數、查定數與實徵數 (續8)

(二)稅課收入

8. 娛樂稅

單位：新臺幣元

年度(月)別 Fiscal Year (Month)	預算數 Budget Amount (A)	查定數 Audited Amount		
		合計 Total	本年度 Current FY	以前年度 Previous FY
94 年度 FY 2005	210,000,000	305,317,612	246,157,608	59,160,004
95 年度 FY 2006	238,000,000	305,881,025	245,462,724	60,418,301
96 年度 FY 2007	240,000,000	275,783,980	220,725,583	55,058,397
97 年度 FY 2008	242,000,000	268,489,788	224,280,384	44,209,404
98 年度 FY 2009	220,000,000	242,229,432	212,177,330	30,052,102
99 年度 FY 2010	210,000,000	248,327,528	228,981,000	19,346,528
100 年度 FY 2011	200,000,000	259,975,890	245,430,367	14,545,523
101 年度 FY 2012	200,000,000	239,594,695	227,269,673	12,325,022
102 年度 FY 2013	230,000,000	241,617,104	228,753,147	12,863,957
103 年度 FY 2014	215,000,000	247,274,144	236,576,455	10,697,689
1 月 Jan.	17,395,000	30,786,309	18,350,295	12,436,014
2 月 Feb.	14,701,000	24,972,009	25,039,196	- 67,187
3 月 Mar.	18,347,000	16,761,645	16,831,831	- 70,186
4 月 Apr.	19,085,000	17,747,792	17,972,380	- 224,588
5 月 May	18,822,000	17,370,648	17,599,619	- 228,971
6 月 June	17,612,000	17,312,161	17,530,793	- 218,632
7 月 July	22,801,000	23,452,044	23,699,845	- 247,801
8 月 Aug.	22,644,000	21,526,344	21,629,361	- 103,017
9 月 Sep.	19,573,000	22,104,441	22,223,912	- 119,471
10 月 Oct.	16,099,000	14,864,544	15,091,273	- 226,729
11 月 Nov.	13,443,000	22,157,917	22,293,315	- 135,398
12 月 Dec.	14,478,000	18,218,290	18,314,635	- 96,345

Table 2. Budget Amount, Audited Amount and Actual Collection
in Recent Years (Cont. 8)

(II) Revenues from Taxes

8. Amusement Tax

Unit : N.T.\$1

實 徵 數 Actual Collection			退還以前年度 歲入款 Tax Income Returned (4)	實 徵 淨 額 Net Actual Collection (1-4=5)	實徵淨額 占預算數 % Net Actual Collection /Budge Amount (5/A)×100
合 計 Total (2+3=1)	本 年 度 Current FY (2)	以 前 年 度 Previous FY (3)			
242,091,551	237,515,640	4,575,911	4,027	242,087,524	115.3
244,097,516	238,934,679	5,162,837	97,763	243,999,753	102.5
216,736,034	212,172,220	4,563,814	19,492,764	197,243,270	82.2
221,995,693	218,593,813	3,401,880	9,506,701	212,488,992	87.8
210,098,246	207,121,900	2,976,346	75,284	210,022,962	95.5
226,941,170	224,986,040	1,955,130	68,614	226,872,556	108.0
244,111,111	242,285,021	1,826,090	303,664	243,807,447	121.9
224,615,319	222,583,805	2,031,514	477,451	224,137,868	112.1
228,951,423	225,358,394	3,593,029	24,053	228,927,370	99.5
235,077,518	232,633,550	2,443,968	202,710	234,874,808	109.2
18,314,507	17,375,717	938,790	59,094	18,255,413	104.9
24,427,029	24,116,341	310,688	7,127	24,419,902	166.1
15,864,488	15,630,048	234,440	2	15,864,486	86.5
19,459,425	19,275,909	183,516	3,291	19,456,134	101.9
16,382,858	16,313,054	69,804	7,080	16,375,778	87.0
18,565,206	18,483,613	81,593	—	18,565,206	105.4
23,311,578	23,275,405	36,173	—	23,311,578	102.2
20,591,155	20,541,161	49,994	1,976	20,589,179	90.9
22,730,587	22,482,737	247,850	28,670	22,701,917	116.0
13,997,632	13,938,241	59,391	94,937	13,902,695	86.4
22,798,022	22,628,368	169,654	—	22,798,022	169.6
18,635,031	18,572,956	62,075	533	18,634,498	128.7

表 2 歷年各項稅捐預算數、查定數與實徵數 (續9)

(二)稅課收入

9. 九年國民義務教育附徵教育經費

單位：新臺幣元

(1)小計

年度(月)別 Fiscal Year (Month)	預算數 Budget Amount (A)	查定數 Audited Amount		
		合計 Total	本年度 Current FY	以前年度 Previous FY
94 年度 FY 2005	—	26,775,123	28,543	26,746,580
95 年度 FY 2006	—	21,939,547	—	21,939,547
96 年度 FY 2007	—	16,530,226	—	16,530,226
97 年度 FY 2008	—	12,539,866	—	12,539,866
98 年度 FY 2009	—	8,274,576	—	8,274,576
99 年度 FY 2010	—	4,999,750	—	4,999,750
100 年度 FY 2011	—	2,226,710	—	2,226,710
101 年度 FY 2012	—	1,200,781	—	1,200,781
102 年度 FY 2013	—	745,571	—	745,571
103 年度 FY 2014	—	424,665	—	424,665
1 月 Jan.	—	672,061	—	672,061
2 月 Feb.	—	- 33,691	—	- 33,691
3 月 Mar.	—	—	—	—
4 月 Apr.	—	—	—	—
5 月 May	—	—	—	—
6 月 June	—	—	—	—
7 月 July	—	- 1,919	—	- 1,919
8 月 Aug.	—	- 211,786	—	- 211,786
9 月 Sep.	—	—	—	—
10 月 Oct.	—	—	—	—
11 月 Nov.	—	—	—	—
12 月 Dec.	—	—	—	—

Table 2. Budget Amount, Audited Amount and Actual Collection
in Recent Years (Cont. 9)

(II) Revenues from Taxes

9. Education Surtax

(1)Subtotal

Unit : N.T.\$1

實徵數 Actual Collection			退還以前年度 歲入款 Tax Income Returned (4)	實徵淨額 Net Actual Collection (1-4=5)	實徵淨額 占預算數 % Net Actual Collection /Budge Amount (5/A)×100
合計 Total (2+3=1)	本年度 Current FY (2)	以前年度 Previous FY (3)			
2,913,698	28,543	2,885,155	9,414	2,904,284	--
1,303,967	—	1,303,967	38,877	1,265,090	--
1,386,379	—	1,386,379	12,263	1,374,116	--
755,593	—	755,593	—	755,593	--
355,000	—	355,000	1,231,783	- 876,783	--
668,897	—	668,897	10,629,176	- 9,960,279	--
344,041	—	344,041	341,047	2,994	--
304,361	—	304,361	40,452	263,909	--
73,510	—	73,510	—	73,510	--
81,667	—	81,667	38,864	42,803	--
81,667	—	81,667	—	81,667	--
—	—	—	—	—	--
—	—	—	—	—	--
—	—	—	—	—	--
—	—	—	—	—	--
—	—	—	—	—	--
—	—	—	—	—	--
—	—	—	38,864	- 38,864	--
—	—	—	—	—	--
—	—	—	—	—	--
—	—	—	—	—	--

表 2 歷年各項稅捐預算數、查定數與實徵數 (續10)

(二)稅課收入

9. 九年國民義務教育附徵教育經費

單位：新臺幣元

(2)房屋稅

年度(月)別 Fiscal Year (Month)	預算數 Budget Amount (A)	查定數 Audited Amount		
		合計 Total	本年度 Current FY	以前年度 Previous FY
94 年度 FY 2005	—	22,852,091	28,543	22,823,548
95 年度 FY 2006	—	18,474,872	—	18,474,872
96 年度 FY 2007	—	13,738,671	—	13,738,671
97 年度 FY 2008	—	10,259,504	—	10,259,504
98 年度 FY 2009	—	7,692,721	—	7,692,721
99 年度 FY 2010	—	4,894,676	—	4,894,676
100 年度 FY 2011	—	2,213,603	—	2,213,603
101 年度 FY 2012	—	1,200,781	—	1,200,781
102 年度 FY 2013	—	745,571	—	745,571
103 年度 FY 2014	—	424,665	—	424,665
1 月 Jan.	—	672,061	—	672,061
2 月 Feb.	—	- 33,691	—	- 33,691
3 月 Mar.	—	—	—	—
4 月 Apr.	—	—	—	—
5 月 May	—	—	—	—
6 月 June	—	—	—	—
7 月 July	—	- 1,919	—	- 1,919
8 月 Aug.	—	- 211,786	—	- 211,786
9 月 Sep.	—	—	—	—
10 月 Oct.	—	—	—	—
11 月 Nov.	—	—	—	—
12 月 Dec.	—	—	—	—

Table 2. Budget Amount, Audited Amount and Actual Collection
in Recent Years (Cont. 10)

(II) Revenues from Taxes

9. Education Surtax

(2) House Tax

Unit : N.T.\$1

實徵數 Actual Collection			退還以前年度 歲入款 Tax Income Returned (4)	實徵淨額 Net Actual Collection (1-4=5)	實徵淨額 占預算數 % Net Actual Collection /Budge Amount (5/A)×100
合計 Total (2+3=1)	本年度 Current FY (2)	以前年度 Previous FY (3)			
2,831,690	28,543	2,803,147	9,414	2,822,276	--
1,251,965	--	1,251,965	38,877	1,213,088	--
1,307,026	--	1,307,026	11,356	1,295,670	--
735,622	--	735,622	--	735,622	--
343,930	--	343,930	1,231,783	-887,853	--
664,650	--	664,650	10,629,176	- 9,964,526	--
344,041	--	344,041	341,047	2,994	--
304,361	--	304,361	40,452	263,909	--
73,510	--	73,510	--	73,510	--
81,667	--	81,667	38,864	42,803	--
81,667	--	81,667	--	81,667	--
--	--	--	--	--	--
--	--	--	--	--	--
--	--	--	--	--	--
--	--	--	--	--	--
--	--	--	--	--	--
--	--	--	--	--	--
--	--	--	38,864	- 38,864	--
--	--	--	--	--	--
--	--	--	--	--	--
--	--	--	--	--	--

表 2 歷年各項稅捐預算數、查定數與實徵數 (續11)

(二)稅課收入

9. 九年國民義務教育附徵教育經費

單位：新臺幣元

(3)娛樂稅

年度(月)別 Fiscal Year (Month)	預算數 Budget Amount (A)	查定數 Audited Amount		
		合計 Total	本年度 Current FY	以前年度 Previous FY
94 年度 FY 2005	—	3,923,032	—	3,923,032
95 年度 FY 2006	—	3,464,675	—	3,464,675
96 年度 FY 2007	—	2,791,555	—	2,791,555
97 年度 FY 2008	—	2,280,362	—	2,280,362
98 年度 FY 2009	—	581,855	—	581,855
99 年度 FY 2010	—	105,074	—	105,074
100 年度 FY 2011	—	13,107	—	13,107
101 年度 FY 2012	—	—	—	—
102 年度 FY 2013	—	—	—	—
103 年度 FY 2014	—	—	—	—
1 月 Jan.	—	—	—	—
2 月 Feb.	—	—	—	—
3 月 Mar.	—	—	—	—
4 月 Apr.	—	—	—	—
5 月 May	—	—	—	—
6 月 June	—	—	—	—
7 月 July	—	—	—	—
8 月 Aug.	—	—	—	—
9 月 Sep.	—	—	—	—
10 月 Oct.	—	—	—	—
11 月 Nov.	—	—	—	—
12 月 Dec.	—	—	—	—

表 2 歷年各項稅捐預算數、查定數與實徵數 (續12)

(三)工程受益費

單位：新臺幣元

年度(月)別 Fiscal Year (Month)	預算數 Budget Amount (A)	查定數 Audited Amount		
		合計 Total	本年度 Current FY	以前年度 Previous FY
94 年度 FY 2005	—	73,882	—	73,882
95 年度 FY 2006	—	45,351	—	45,351
96 年度 FY 2007	—	116,439	—	116,439
97 年度 FY 2008	—	—	—	—
98 年度 FY 2009	—	—	—	—
99 年度 FY 2010	—	—	—	—
100 年度 FY 2011	—	42,197	—	42,197
101 年度 FY 2012	—	—	—	—
102 年度 FY 2013	—	—	—	—
103 年度 FY 2014	—	—	—	—
1 月 Jan.	—	—	—	—
2 月 Feb.	—	—	—	—
3 月 Mar.	—	—	—	—
4 月 Apr.	—	—	—	—
5 月 May	—	—	—	—
6 月 June	—	—	—	—
7 月 July	—	—	—	—
8 月 Aug.	—	—	—	—
9 月 Sep.	—	—	—	—
10 月 Oct.	—	—	—	—
11 月 Nov.	—	—	—	—
12 月 Dec.	—	—	—	—

表 2 歷年各項稅捐預算數、查定數與實徵數 (續13)

(四)罰鍰收入

單位：新臺幣元

年度(月)別 Fiscal Year (Month)	預算數 Budget Amount (A)	查定數 Audited Amount		
		合計 Total	本年度 Current FY	以前年度 Previous FY
94 年度 FY 2005	188,000,000	464,605,562	118,648,479	345,957,083
95 年度 FY 2006	183,000,000	437,452,233	72,706,354	364,745,879
96 年度 FY 2007	183,000,000	442,108,236	126,466,198	315,642,038
97 年度 FY 2008	204,000,000	475,339,022	162,206,174	313,132,848
98 年度 FY 2009	201,000,000	494,714,768	157,439,459	337,275,309
99 年度 FY 2010	155,000,000	547,722,155	204,193,586	343,528,569
100 年度 FY 2011	154,000,000	563,414,313	133,481,505	429,932,808
101 年度 FY 2012	135,000,000	496,099,434	98,656,201	397,443,233
102 年度 FY 2013	131,000,000	493,644,600	101,500,747	392,143,853
103 年度 FY 2014	104,000,000	428,292,564	74,173,335	354,119,229
1 月 Jan.	7,898,000	356,312,525	4,951,174	351,361,351
2 月 Feb.	8,319,000	5,942,901	5,602,782	340,119
3 月 Mar.	8,100,000	9,480,741	8,798,969	681,772
4 月 Apr.	10,477,000	10,808,560	10,070,958	737,602
5 月 May	11,009,000	14,392,304	14,903,376	- 511,072
6 月 June	9,365,000	10,349,827	11,023,477	- 673,650
7 月 July	9,379,000	5,594,129	4,878,272	715,857
8 月 Aug.	6,278,000	5,249,347	2,973,641	2,275,706
9 月 Sep.	8,414,000	436,060	577,014	- 140,954
10 月 Oct.	5,824,000	2,141,761	1,883,407	258,354
11 月 Nov.	8,284,000	1,662,529	3,102,508	- 1,439,979
12 月 Dec.	10,653,000	5,921,880	5,407,757	514,123

Table 2. Budget Amount, Audited Amount and Actual Collection
in Recent Years (Cont. 13)

(IV) Punitive Fine Revenue

Unit : N.T.\$1

實徵數 Actual Collection			退還以前年度 歲入款 Tax Income Returned (4)	實徵淨額 Net Actual Collection (1-4=5)	實徵淨額 占預算數 % Net Actual Collection /Budget Amount (5/A)×100
合計 Total (2+3=1)	本年度 Current FY (2)	以前年度 Previous FY (3)			
223,858,767	67,694,444	156,164,323	13,162,067	210,696,700	112.1
230,087,703	53,836,140	176,251,563	4,777,848	225,309,855	123.1
191,975,376	58,776,047	133,199,329	6,943,632	185,031,744	101.1
191,887,419	64,189,183	127,698,236	8,921,665	182,965,754	89.7
199,652,733	58,490,467	141,162,266	47,262,251	152,390,482	75.8
165,963,949	62,178,322	103,785,627	105,644,011	60,319,938	38.9
188,127,746	59,663,707	128,464,039	27,995,613	160,132,133	104.0
130,740,906	43,159,508	87,581,398	12,973,313	117,767,593	87.2
143,182,097	55,284,547	87,897,550	13,370,440	129,811,657	99.1
105,643,689	41,076,486	64,567,203	3,757,801	101,885,888	98.0
11,008,878	2,011,586	8,997,292	1,151,486	9,857,392	124.8
6,434,247	623,279	5,810,968	1,009,554	5,424,693	65.2
9,898,396	3,401,307	6,497,089	105,495	9,792,901	120.9
7,474,840	1,348,166	6,126,674	114,313	7,360,527	70.3
11,621,761	6,245,960	5,375,801	281,304	11,340,457	103.0
10,101,446	5,093,067	5,008,379	71,528	10,029,918	107.1
9,299,242	3,381,927	5,917,315	142,924	9,156,318	97.6
10,107,816	3,888,325	6,219,491	154,144	9,953,672	158.5
5,588,190	2,163,723	3,424,467	178,522	5,409,668	64.3
7,769,028	2,939,496	4,829,532	33,952	7,735,076	132.8
6,529,478	4,011,361	2,518,117	338,737	6,190,741	74.7
9,810,367	5,968,289	3,842,078	175,842	9,634,525	90.4

表 2 歷年各項稅捐預算數、查定數與實徵數 (續14完)

(五)規費收入

單位：新臺幣元

監證費

年度(月)別 Fiscal Year (Month)	預算數 Budget Amount (A)	查定數 Audited Amount		
		合計 Total	本年度 Current FY	以前年度 Previous FY
94 年度 FY 2005	—	—	—	—
95 年度 FY 2006	—	—	—	—
96 年度 FY 2007	—	4,097	—	4,097
97 年度 FY 2008	—	—	—	—
98 年度 FY 2009	—	149,080	—	149,080
99 年度 FY 2010	—	—	—	—
100 年度 FY 2011	—	—	—	—
101 年度 FY 2012	—	—	—	—
102 年度 FY 2013	—	—	—	—
103 年度 FY 2014	—	—	—	—
1 月 Jan.	—	—	—	—
2 月 Feb.	—	—	—	—
3 月 Mar.	—	—	—	—
4 月 Apr.	—	—	—	—
5 月 May	—	—	—	—
6 月 June	—	—	—	—
7 月 July	—	—	—	—
8 月 Aug.	—	—	—	—
9 月 Sep.	—	—	—	—
10 月 Oct.	—	—	—	—
11 月 Nov.	—	—	—	—
12 月 Dec.	—	—	—	—

表 3 各項稅捐納庫數

(一)歷年別

單位：新臺幣元

年 度 (月) 別 Fiscal Year (Month)	實 徵 數 ① Actual Collection	納 庫 數	
		合 計 Total	國 庫 Nation Treasury
94 年 度 FY 2005	60,821,499,933	60,821,258,612	—
95 年 度 FY 2006 ③	59,935,082,828	59,934,140,690	—
96 年 度 FY 2007 ④	62,211,212,658	62,211,212,658	—
97 年 度 FY 2008 ⑤	57,349,343,608	57,349,343,608	—
98 年 度 FY 2009	57,906,303,509	57,906,010,169	—
99 年 度 FY 2010 ⑥	61,412,898,686	61,412,898,686	—
100 年 度 FY 2011	62,364,742,945	62,364,742,945	—
101 年 度 FY 2012 ⑦	62,751,393,789	62,751,393,789	—
102 年 度 FY 2013 ⑧	66,673,882,137	66,673,882,137	—
103 年 度 FY 2014	67,721,827,234	67,721,827,234	—
1 月 Jan.	3,074,406,808	2,697,536,570	—
2 月 Feb.	1,763,487,475	1,879,160,161	—
3 月 Mar.	3,509,581,295	2,914,783,026	—
4 月 Apr.	5,770,097,153	5,026,892,370	—
5 月 May	11,243,148,364	9,583,310,284	—
6 月 June	6,704,858,908	9,614,878,588	—
7 月 July	2,402,402,060	2,442,448,253	—
8 月 Aug.	1,991,412,238	1,981,891,304	—
9 月 Sep.	2,180,652,708	2,226,539,476	—
10 月 Oct.	2,505,995,513	2,181,315,703	—
11 月 Nov.	12,859,768,848	7,697,730,850	—
12 月 Dec.	13,716,015,864	19,475,340,649	—

資料來源：依據徵課會計報告編製。

附 註：①自99年度起實徵數未含實物抵繳稅款(以遞延收入入帳)。

②年度之未納庫數係歷年實物抵繳稅款累計數。

③以前年度實物抵繳23,648元於95年度變賣納庫。

④以前年度實物抵繳26,763元於96年度變賣納庫。

Table 3. Taxation Forwarded to Treasury

(I) Fiscal Year

Unit : N.T.\$1

Pay to Treasury			未納庫數 Unpay to ② Treasury
中央統籌專戶 Distribution of Central Gov't	重建基金庫 Reconstruction Fund	市庫 The Municipal Treasury	
—	—	60,821,258,612	57,995,601
—	—	59,934,140,690	58,914,091
—	—	62,211,212,658	58,887,328
—	—	57,349,343,608	58,886,859
—	—	57,906,010,169	59,180,199
—	—	61,412,898,686	59,145,876
—	—	62,364,742,945	59,145,876
—	—	62,751,393,789	59,489,460
—	—	66,673,882,137	59,451,157
—	—	67,721,827,234	59,451,157
—	—	2,697,536,570	376,870,238
—	—	1,879,160,161	261,197,552
—	—	2,914,783,026	855,995,821
—	—	5,026,892,370	1,599,200,604
—	—	9,583,310,284	3,259,038,684
—	—	9,614,878,588	349,019,004
—	—	2,442,448,253	308,972,811
—	—	1,981,891,304	318,493,745
—	—	2,226,539,476	272,606,977
—	—	2,181,315,703	597,286,787
—	—	7,697,730,850	5,759,324,785
—	—	19,475,340,649	—

⑤ 以前年度實物抵繳469元於97年度變賣納庫。

⑥ 以前年度實物抵繳34,323元於99年度變賣納庫。

⑦ 101年度未納庫數含實物抵繳343,584元。

⑧ 以前年度實物抵繳38,303元於102年度變賣納庫。

表 3 各項稅捐納庫數(續)

(二)稅目別
103年度

單位：新臺幣元

稅目別 Item of Tax	實徵數 Actual Collection	納庫數 Pay to Treasury			
		合計 Total	國庫 The Nation Treasury	中央統籌專戶 Distribution of Central Gov't	重建基金庫 Reconstruction Fund
總計 Grand Total	67,721,827,234	67,721,827,234	—	—	—
地價稅 Land Value Tax	22,520,360,611	22,520,360,611	—	—	—
土地增值稅 Land value Increment Tax	19,303,115,028	19,303,115,028	—	—	—
房屋稅 House Tax	12,221,541,822	12,221,541,822	—	—	—
使用牌照稅 Vehicle License Tax	7,118,817,681	7,118,817,681	—	—	—
契稅 Deed Tax	1,656,050,355	1,656,050,355	—	—	—
印花稅 Stamp Tax	4,561,138,863	4,561,138,863	—	—	—
娛樂稅 Amusement Tax	235,077,518	235,077,518	—	—	—
教育經費 Education Surtax	81,667	81,667	—	—	—
工程受益費 Construction Benefit Fee	—	—	—	—	—
罰鍰收入 Punitive Fine Revenue	105,643,689	105,643,689	—	—	—
規費收入 Fees Revenue	—	—	—	—	—

Table 3. Taxation Forwarded to Treasury (Cont.)

(II) Item of Tax				
FY 2014				
Unit : N.T.\$1				
退還以前年度歲入款 Tax Income Returned				
市 庫 The Municipal Treasury	合 計 Total	國 庫 The Nation Treasury	中央統籌專戶 Distribution of Central Gov't	市 庫 The Municipal Treasury
67,721,827,234	328,817,075	—	—	328,817,075
22,520,360,611	72,405,760	—	—	72,405,760
19,303,115,028	236,107,832	—	—	236,107,832
12,221,541,822	4,407,746	—	—	4,407,746
7,118,817,681	4,939,003	—	—	4,939,003
1,656,050,355	5,414,521	—	—	5,414,521
4,561,138,863	1,542,838	—	—	1,542,838
235,077,518	202,710	—	—	202,710
81,667	38,864	—	—	38,864
—	—	—	—	—
105,643,689	3,757,801	—	—	3,757,801
—	—	—	—	—

表 4 歷年各項稅捐實徵淨額及指數

基 比：100年度=100

環 比：上年度=100

分 配 比：各年度總計=100

單位：新臺幣千元

稅 目 別 Item of Tax	94年度 FY2005	95年度 FY2006			96年度	
	實徵淨額 Net Actual Collection	實徵淨額 Net Actual Collection	指數 Index		分配比 Shares	實徵淨額 Net Actual Collection
			基 比 Fixed Index	環 比 Link Index		
總 計 Grand Total	60,543,000	59,559,142	95.8	98.4	100.0	61,880,951
稅 課 收 入 Revenues from Taxes	60,332,240	59,333,787	95.7	98.3	99.6	61,695,799
地 價 稅 Land Value Tax	17,557,773	17,900,813	87.3	102.0	30.1	19,468,697
土地增值稅 Land Value Increment Tax	20,254,961	18,608,089	106.9	91.9	31.2	19,037,783
房 屋 稅 House Tax	9,890,207	9,997,706	92.0	101.1	16.8	10,091,271
使用牌照稅 Vehicle License Tax	6,471,516	6,442,749	95.8	99.6	10.8	6,562,146
契 稅 Deed Tax	2,328,136	2,389,860	119.2	102.7	4.0	2,468,967
印 花 稅 Stamp Tax	3,584,655	3,749,305	88.3	104.6	6.3	3,868,318
娛 樂 稅 Amusement Tax	242,088	244,000	100.1	100.8	0.4	197,243
教育經費 Education Surtax	2,904	1,265	42,166.7	43.6	0.0	1,374
工程受益費 Construction Benefit Fee	74	45	107.1	60.8	0.0	116
罰 鍰 收 入 Punitive Fine Revenue	210,697	225,310	140.7	106.9	0.4	185,032
規 費 收 入 Fees Revenue	- 11	—	--	--	--	4
契稅監證費 Fees	- 11	—	--	--	--	4

資料來源：依據徵課會計報告編製。

Table 4. Net Amount Remitted and Index in Recent Years

Fixed Index:FY2011=100

Link Index:Last Year=100

Shares:Total=100

Unit:N.T.\$1,000

FY 2007			97年度 FY2008				98年度 FY2009			
指數 Index		分配比 Shares	實徵淨額 Net Actual Collection	指數 Index		分配比 Shares	實徵淨額 Net Actual Collection	指數 Index		分配比 Shares
基 比 Fixed Index	環 比 Link Index			基 比 Fixed Index	環 比 Link Index			基 比 Fixed Index	環 比 Link Index	
99.6	103.9	100.0	56,753,478	91.3	91.7	100.0	57,498,023	92.5	101.3	100.0
99.5	104.0	99.7	56,570,534	91.2	91.7	99.7	57,345,484	92.5	101.4	99.7
94.9	108.8	31.5	19,188,394	93.6	98.6	33.8	18,702,394	91.2	97.5	32.5
109.4	102.3	30.8	13,549,409	77.8	71.2	23.9	15,413,916	88.5	113.8	26.8
92.9	100.9	16.3	10,140,620	93.3	100.5	17.9	10,295,486	94.8	101.5	17.9
97.6	101.9	10.6	6,536,438	97.2	99.6	11.5	6,462,009	96.1	98.9	11.2
123.2	103.3	4.0	2,369,087	118.2	96.0	4.2	2,357,002	117.6	99.5	4.1
91.1	103.2	6.2	4,573,341	107.7	118.2	8.0	3,905,531	92.0	85.4	6.8
80.9	80.8	0.3	212,489	87.2	107.7	0.4	210,023	86.1	98.8	0.4
45,800.0	108.6	0.0	756	25,200.0	55.0	0.0	- 877	--	--	- 0.0
276.2	257.8	0.0	- 22	--	--	- 0.0	--	--	--	--
115.5	82.1	0.3	182,966	114.3	98.9	0.3	152,390	95.2	83.3	0.3
--	--	0.0	--	--	--	--	149	--	--	0.0
--	--	0.0	--	--	--	--	149	--	--	0.0

表 5 本處各項稅捐稽徵成本①②

Table 5. Cost of Tax Levying ①②

年度及稅目別 Fiscal Year & Item of Tax	實徵淨額 (千元) Net Actual Collection (N.T.\$1000) (1)	實支經費 (元) Expense (N.T.\$1) (2)	每千元成本 (元) Cost of \$1,000 (2)/(1)
94 年度 FY 2005	60,332,240	896,828,571	14.8648
95 年度 FY 2006	59,333,787	914,484,276	15.4125
96 年度 FY 2007	61,695,799	898,794,972	14.5682
97 年度 FY 2008	56,570,534	894,798,178	15.8174
98 年度 FY 2009	57,345,484	894,489,263	15.5983
99 年度 FY 2010	60,844,915	899,839,885	14.7891
100 年度 FY 2011	61,999,268	888,513,303	14.3310
101 年度 FY 2012	62,189,138	893,122,419	14.3614
102 年度 FY 2013	66,310,719	904,340,532	13.6379
103 年度 FY 2014	67,291,124	915,806,028	13.6096
地價稅 Land Value Tax	22,447,955	264,009,638	11.7610
土地增值稅 Land Value Increment Tax	19,067,007	204,995,719	10.7513
房屋稅 House Tax	12,217,177	219,520,817	17.9682
使用牌照稅 Vehicle License Tax	7,113,878	115,926,724	16.2959
契稅 Deed Tax	1,650,636	49,695,932	30.1071
印花稅 Stamp Tax	4,559,596	34,074,600	7.4732
娛樂稅 Amusement Tax	234,875	27,582,598	117.4352

資料來源：根據本處會計室資料編製。

附註：①依據財政部賦稅署擬訂之各稅稽徵成本計算方式一致性規定說明書之編算原則核計。

②房屋稅與娛樂稅實徵淨額含九年國民義務教育附徵教育經費。

參、稅源及其他

III . Tax Sources and Others

表 6 地價稅稅源

單位 { 面積：公頃
金額：新臺幣千元

年別及稅地種類別		戶數	筆數
Year & Classification		No. of House	Plots
98	年 2009	834,400	1,782,383
99	年 2010	843,247	1,814,594
100	年 2011	852,009	1,843,386
101	年 2012	860,251	1,868,226
102	年 2013	867,911	1,917,506
103	年 2014	875,372	1,941,736
公	有 Public	397	135,949
一般土地	Regular Land	379	122,787
自用住宅用地	Self-use Residence Land	8	168
工礦業等用地	Specific Business Land	—	272
公共設施保留地	Land Reserved for Public Facilities	10	12,722
私	有 Private	874,975	1,805,787
一般土地	Regular Land	379,713	825,558
第一級	Level 1	376,078	784,256
第二級	Level 2	3,109	28,097
第三級	Level 3	261	2,593
第四級	Level 4	96	1,408
第五級	Level 5	47	677
第六級	Level 6	122	8,527
自用住宅用地	Self-use Residence Land	492,638	907,273
都市土地	Urban Land	492,638	907,273
非都市土地	Non-Urban Land	—	—
工礦業等用地	Specific Business Land	28	1,507
公共設施保留地	Land Reserved for Public Facilities	2,596	71,449

資料來源：根據本處財產稅科資料編製。

Table 6. Sources of Land Value Tax

Unit: { Area : Hectare Amount : N.T.\$1,000		
課 稅 面 積 Taxed Area	課 稅 地 價 Taxed Land Value	地 價 稅 額 Land Value Tax
4,835.7439	1,911,687,078	18,425,014
4,959.2458	2,091,696,127	20,056,339
4,915.9018	2,087,899,910	20,131,896
5,034.7634	2,096,510,787	20,339,436
4,951.7003	2,247,409,509	22,164,453
4,971.4676	2,253,998,074	22,260,505
329.6468	183,596,673	1,763,128
301.3653	171,760,171	1,717,602
21.0222	6,543,819	13,088
0.2699	170,585	1,706
6.9892	5,122,098	30,733
4,641.8207	2,070,401,401	20,497,377
2,390.5545	1,062,418,399	18,135,195
1,555.0690	644,285,660	6,442,845
396.0704	159,891,325	1,999,752
80.8175	40,701,577	677,357
51.7897	30,124,783	656,480
26.2848	17,963,248	474,609
280.5227	169,451,806	7,884,151
2,068.4999	956,211,634	1,912,394
2,068.4999	956,211,634	1,912,394
—	—	—
79.9745	34,790,190	347,902
102.7917	16,981,177	101,886

表 7 土地增值稅稅源

單位 { 面積：公頃
金額：新臺幣千元

年度及稅率別 Fiscal Year & Rate of Tax	筆數 Plots	面積 Area	移轉現值 Present Value of Transfer	調整後原地價 Originally Declared Value After Adjustment	
94 年 度 FY2005	132,593	683.7837	465,562,997	286,530,211	
95 年 度 FY2006	137,910	610.5693	452,335,486	311,509,340	
96 年 度 FY2007	133,614	598.8314	449,354,075	309,302,178	
97 年 度 FY2008	134,635	513.1119	418,194,495	299,218,322	
98 年 度 FY2009	124,589	415.3626	411,747,421	286,607,620	
99 年 度 FY2010	138,294	509.0032	440,310,323	305,753,138	
100 年 度 FY2011	127,170	436.1678	382,853,776	252,580,246	
101 年 度 FY2012	102,169	334.1813	321,992,197	193,999,469	
102 年 度 FY2013	105,050	324.0251	353,553,228	200,038,953	
103 年 度 FY2014	96,178	301.5794	325,747,728	167,132,088	
自用住宅用地 稅率10%	Self-use Residence Land (Rate 10%)	10,357	22.1748	50,543,734	21,211,159
一般用地	Regular Land	54,448	112.2953	186,338,284	104,295,039
稅率20%	Rate 20%	43,754	67.9770	134,624,109	95,876,898
稅率30%	Rate 30%	2,441	14.0150	12,406,413	5,215,502
稅率40%	Rate 40%	8,238	30.3032	39,307,762	3,202,640
其他	Others	15	0.0000	—	—
免稅地	Exempt Land	31,373	167.1093	88,865,710	41,625,891
公有土地	Public Land	894	3.9695	15,826,819	1,918,974
私有土地	Private Land	30,479	163.1398	73,038,891	39,706,917

資料來源：根據本處財產稅科資料編製。

附註：①102年度起含免稅地相關資料。

Table 7. Sources of Land Value Increment Tax

 Unit: { Area : Hectare
 Amount : N.T.\$1,000

改良土地費用 Land Improvement Cost	漲價總數額 Cross Amount of Land Value Increment	查定稅額① Assessment Tax	增繳地價稅① Supplemental Payment of Land Value Tax	減徵稅額① Reduction	應納稅額 Tax Payable
1,675,612	177,357,174	25,564,553	1,111,589	1,262,153	23,190,811
4,241,536	136,584,610	20,497,584	908,315	1,319,686	18,269,583
2,264,726	137,787,171	22,179,717	946,091	1,002,950	20,230,676
1,266,847	117,709,326	16,157,946	611,854	428,479	15,117,613
2,003,969	123,135,832	17,240,793	684,454	709,141	15,847,198
1,429,814	133,127,371	19,232,065	773,734	861,337	17,596,994
659,623	129,613,907	18,695,238	727,894	646,878	17,320,466
261,858	127,730,870	17,406,309	705,764	550,475	16,150,070
335,014	157,067,733	38,289,539	817,989	441,657	20,368,311
1,607,913	159,997,437	38,641,701	949,642	1,379,617	20,962,675
12,280	29,320,300	2,932,025	132,804	21,418	2,776,174
1,575,658	80,467,587	20,238,165	716,951	1,297,547	18,186,501
36,804	38,710,408	7,742,407	201,023	23,879	7,509,788
34	7,190,877	1,627,717	69,704	148,696	1,405,176
1,538,821	34,566,302	10,866,279	446,224	1,124,972	9,269,774
—	—	1,763	—	—	1,763
19,975	50,209,550	15,471,511	99,888	60,652	—
—	14,080,932	4,587,057	33,675	—	—
19,975	36,128,618	10,884,453	66,213	60,652	—

表 8 房 屋 稅 稅 源

單位 { 面積：平方公尺
金額：新臺幣千元

年度別、構造及使用別 Fiscal Year & Structure & Use				合計 Total		
				戶 數 Number of House	面 積 Area	現 值 Value
99	年	度	FY2010	1,080,152	176,383,620	741,065,141
100	年	度	FY2011	1,089,541	178,554,255	753,492,124
101	年	度	FY2012	1,097,581	180,692,750	832,912,306
102	年	度	FY2013	1,105,979	184,555,387	846,250,956
103	年	度	FY2014	1,112,554	187,129,628	860,003,225
住	家	用	Residence	776,820	83,839,196	334,798,157
營	業	用	Business	144,684	32,589,431	235,474,754
非住家非營業用			Non-Residence · Non-Business	49,824	15,861,983	91,007,893
全部免稅及部份免稅			Exempt House	141,226	54,839,018	198,722,422
鋼 骨 混 凝 土 造			Steeled Concrete	31,227	22,066,324	235,741,855
住	家	用	Residence	15,289	2,596,822	46,430,982
營	業	用	Business	9,042	7,491,400	99,987,135
非住家非營業用			Non-Residence · Non-Business	4,987	4,147,365	37,132,893
全部免稅及部份免稅			Exempt House	1,909	7,830,737	52,190,845
鋼 筋 混 凝 土 及 預 鑄 造			Concrete&Reinforced Prefabricated	936,386	147,462,595	603,134,047
住	家	用	Residence	706,630	73,169,799	277,944,953
營	業	用	Business	113,774	22,024,431	131,281,297
非住家非營業用			Non-Residence · Non-Business	42,525	11,260,577	53,255,278
全部免稅及部份免稅			Exempt House	73,457	41,007,787	140,652,520
鋼 筋 混 凝 土 加 強 磚 造			Ferroconcrete Brick	100,949	12,927,582	16,689,360
住	家	用	Residence	47,731	6,870,864	9,013,551
營	業	用	Business	14,733	2,112,371	3,138,106
非住家非營業用			Non-Residence · Non-Business	1,551	303,713	434,344
全部免稅及部份免稅			Exempt House	36,934	3,640,634	4,103,359
鋼 鐵 造			Metal	6,691	1,438,688	1,790,229
住	家	用	Residence	2,652	433,083	575,211
營	業	用	Business	1,940	552,153	692,219
非住家非營業用			Non-Residence · Non-Business	285	73,644	90,329
全部免稅及部份免稅			Exempt House	1,814	379,807	432,471

資料來源：根據本處財產稅科資料編製。

Table 8. Sources of House Tax

Unit: $\left\{ \begin{array}{l} \text{Area : m}^2 \\ \text{Amount : N.T. \$1,000} \end{array} \right.$

公有 Public			私有 Private		
戶數 Number of House	面積 Area	現值 Value	戶數 Number of House	面積 Area	現值 Value
26,422	24,158,745	92,550,508	1,053,730	152,224,875	648,514,633
25,223	23,243,844	92,350,866	1,064,318	155,310,411	661,141,259
25,604	23,768,422	101,179,846	1,071,977	156,924,328	731,732,460
25,082	24,155,256	102,135,487	1,080,897	160,400,131	744,115,469
22,095	24,565,303	103,075,967	1,090,459	162,564,325	756,927,258
2,424	311,748	1,234,853	774,396	83,527,447	333,563,303
1,116	1,292,770	8,423,491	143,568	31,296,661	227,051,263
458	1,620,826	5,192,898	49,366	14,241,157	85,814,995
18,097	21,339,959	88,224,725	123,129	33,499,060	110,497,697
618	4,444,041	33,707,522	30,609	17,622,283	202,034,333
39	10,838	88,986	15,250	2,585,984	46,341,996
158	359,233	3,204,953	8,884	7,132,168	96,782,183
72	333,994	1,548,768	4,915	3,813,371	35,584,125
349	3,739,976	28,864,815	1,560	4,090,760	23,326,030
14,085	18,733,268	67,704,475	922,301	128,729,327	535,429,572
2,334	293,038	1,133,932	704,296	72,876,761	276,811,021
772	888,484	5,146,615	113,002	21,135,947	126,134,682
354	1,277,655	3,633,737	42,171	9,982,922	49,621,540
10,625	16,274,091	57,790,191	62,832	24,733,696	82,862,329
2,215	705,194	1,004,987	98,734	12,222,389	15,684,373
24	4,143	7,141	47,707	6,866,721	9,006,410
82	30,197	55,263	14,651	2,082,174	3,082,843
24	4,670	5,693	1,527	299,043	428,651
2,085	666,184	936,890	34,849	2,974,450	3,166,469
207	137,725	218,426	6,484	1,300,963	1,571,803
1	143	153	2,651	432,940	575,058
18	3,400	3,883	1,922	548,754	688,336
1	630	829	284	73,014	89,500
187	133,552	213,561	1,627	246,255	218,910

表 8 房 屋 稅 稅 源 (續)

單位 { 面積：平方公尺
金額：新臺幣千元

年度別、構造及使用別 Fiscal Year & Structure & Use	合計 Total		
	戶 數 Number of House	面 積 Area	現 值 Value
磚 石 造 Brick	26,397	2,502,184	2,229,224
住 家 用 Residence	4,237	714,084	781,688
營 業 用 Business	3,882	316,244	303,325
非住家非營業用 Non-Residence、Non-Business	391	68,032	89,488
全部免稅及部份免稅 Exempt House	17,887	1,403,824	1,054,723
啫 咕 石 造 Lo-Ko Stone	371	25,741	15,311
住 家 用 Residence	9	2,230	1,796
營 業 用 Business	72	2,998	2,212
非住家非營業用 Non-Residence、Non-Business	7	883	549
全部免稅及部份免稅 Exempt House	283	19,630	10,754
卵 石 混 凝 土 造 Concrete & Pebble	39	3,936	3,259
住 家 用 Residence	9	1,642	1,589
營 業 用 Business	1	200	97
非住家非營業用 Non-Residence、Non-Business	2	169	167
全部免稅及部份免稅 Exempt House	27	1,925	1,407
木 造 Wood	9,076	598,866	392,552
住 家 用 Residence	255	47,787	46,674
營 業 用 Business	1,222	85,120	69,825
非住家非營業用 Non-Residence、Non-Business	75	7,491	4,842
全部免稅及部份免稅 Exempt House	7,524	458,468	271,212
土 磚 造 Earthen Brick	1,219	94,287	6,560
住 家 用 Residence	8	2,885	1,714
營 業 用 Business	7	1,139	77
非住家非營業用 Non-Residence、Non-Business	1	107	4
全部免稅及部份免稅 Exempt House	1,203	90,156	4,766
竹 造 Bamboo	199	9,425	828
住 家 用 Residence	—	—	—
營 業 用 Business	11	3,374	461
非住家非營業用 Non-Residence、Non-Business	—	—	—
全部免稅及部份免稅 Exempt House	188	6,051	367

Table 8. Sources of House Tax (Cont.)

 Unit: $\begin{cases} \text{Area : m}^2 \\ \text{Amount : N.T. \$1,000} \end{cases}$

公有 Public			私有 Private		
戶數 Number of House	面積 Area	現值 Value	戶數 Number of House	面積 Area	現值 Value
2,400	338,821	313,777	23,997	2,163,364	1,915,447
22	2,837	3,802	4,215	711,247	777,886
49	8,347	10,821	3,833	307,897	292,505
6	3,848	3,854	385	64,184	85,634
2,323	323,788	295,301	15,564	1,080,036	759,422
24	1,328	775	347	24,413	14,536
—	—	—	9	2,230	1,796
—	—	—	72	2,998	2,212
—	—	—	7	883	549
24	1,328	775	259	18,302	9,979
1	136	58	38	3,800	3,202
—	—	—	9	1,642	1,589
—	—	—	1	200	97
—	—	—	2	169	167
1	136	58	26	1,789	1,349
2,525	203,934	125,918	6,551	394,932	266,634
4	750	840	251	47,037	45,834
37	3,109	1,957	1,185	82,011	67,868
1	29	17	74	7,462	4,825
2,483	200,045	123,104	5,041	258,422	148,107
14	595	19	1,205	93,692	6,541
—	—	—	8	2,885	1,714
—	—	—	7	1,139	77
—	—	—	1	107	4
14	595	19	1,189	89,561	4,747
6	262	10	193	9,163	818
—	—	—	—	—	—
—	—	—	11	3,374	461
—	—	—	—	—	—
6	262	10	182	5,789	357

表 9 使用牌照稅稅源 ① ②

單位：件數

年 度 (月) 別 Fiscal Year (Month)			合 計 Grand Total		小客車③ Sedan	
			應 稅 Taxable	免 稅 Exempt	應 稅 Taxable	免 稅 Exempt
94	年 度	FY2005	808,646	12,591	720,200	11,999
95	年 度	FY2006	735,342	17,237	642,890	16,577
96	年 度	FY2007	742,355	16,855	650,569	16,391
97	年 度	FY2008	746,054	16,177	644,206	15,696
98	年 度	FY2009	740,831	17,330	638,594	16,937
99	年 度	FY2010	760,699	17,301	654,886	16,779
100	年 度	FY2011	785,192	14,007	675,588	13,311
101	年 度	FY2012	807,716	17,117	693,474	16,256
102	年 度	FY2013	830,876	17,321	711,151	16,698
103	年 度	FY2014	879,372	16,690	746,060	15,827
1	月	Jan.	22,051	1,524	19,317	1,495
2	月	Feb.	13,530	1,018	11,498	990
3	月	Mar.	47,291	1,931	40,321	1,865
4	月	Apr.	352,781	1,704	305,598	1,691
5	月	May	267,002	1,710	231,110	1,372
6	月	June	10,912	1,427	9,607	1,403
7	月	July	18,792	1,194	15,910	1,185
8	月	Aug.	13,044	763	10,615	735
9	月	Sep.	12,262	962	9,688	757
10	月	Oct.	36,705	1,312	23,744	1,254
11	月	Nov.	76,642	1,186	61,644	1,162
12	月	Dec.	8,360	1,959	7,008	1,918

資料來源：根據本處機會稅科資料編製。

附 註：①本表臨時牌照、試車牌照及外賓車輛不予計列。

②102年以前件數為本年度實徵件數，103年件數為本年度實徵件數+以前年度實徵件數。

③小客車、大客車、貨車中均分為自用與營業用，自用全年開徵1次。營業用分兩期開徵，表列數字均依照年度結束累計數填列。

Table 9. Sources of Vehicle License Tax ① ②

Unit : Case

大客車③ Bus		貨車③ Truck		機器腳踏車 Motorcycle	
應 稅 Taxable	免 稅 Exempt	應 稅 Taxable	免 稅 Exempt	應 稅 Taxable	免 稅 Exempt
6,424	299	77,151	285	4,871	8
6,418	398	80,153	246	5,881	16
6,639	216	84,277	241	870	7
6,582	257	87,197	220	8,069	4
6,682	213	86,878	168	8,677	12
7,535	318	88,809	171	9,469	33
7,961	520	90,583	154	11,060	22
8,237	643	92,732	197	13,273	21
8,485	423	93,267	164	17,973	36
9,161	528	100,464	311	23,687	24
195	17	1,693	10	846	2
74	21	1,340	6	618	1
253	45	4,170	10	2,547	11
2,305	6	34,865	5	10,013	2
1,704	336	29,142	1	5,046	1
87	16	661	6	557	2
276	2	1,591	7	1,015	—
155	20	1,552	8	722	—
301	37	1,461	167	812	1
2,089	1	10,299	55	573	2
1,435	9	13,071	13	492	2
287	18	619	23	446	—

表 10 契 稅 稅 源

金額單位：新臺幣千元

年 度 (月) 別 Fiscal Year (Month)			合 計 Total		買 賣 契 Sale		典 權 契 Mortgage		
			件 數 Cases	契 價 Deed Value	件 數 Cases	契 價 Deed Value	件 數 Cases	契 價 Deed Value	
94	年 度	FY2005	78,805	42,521,645	70,956	39,447,405	2	183	
95	年 度	FY2006	79,012	41,555,453	71,997	38,820,971	—	—	
96	年 度	FY2007	73,683	41,980,833	65,634	38,907,839	—	—	
97	年 度	FY2008	75,310	41,816,490	67,242	38,369,514	—	—	
98	年 度	FY2009	74,931	41,053,558	66,802	38,260,775	1	486	
99	年 度	FY2010	75,298	40,464,169	66,392	37,287,407	1	0	
100	年 度	FY2011	61,336	35,197,097	51,816	31,575,261	1	133	
101	年 度	FY2012	51,933	31,062,867	41,217	27,193,643	—	—	
102	年 度	FY2013	51,550	29,279,464	41,398	25,134,588	1	513	
103	年 度	FY2014	43,604	29,226,966	32,877	25,239,643	—	—	
	1	月	Jan.	6,567	3,117,862	3,890	2,422,515	—	—
	2	月	Feb.	3,362	2,665,677	2,428	2,439,312	—	—
	3	月	Mar.	2,952	1,015,725	2,243	819,414	—	—
	4	月	Apr.	3,725	2,287,811	3,101	2,122,194	—	—
	5	月	May	3,937	2,212,326	3,338	2,028,052	—	—
	6	月	June	3,135	1,728,873	2,423	1,307,480	—	—
	7	月	July	3,358	1,980,809	2,707	1,706,243	—	—
	8	月	Aug.	3,343	1,956,807	2,659	1,644,065	—	—
	9	月	Sep.	2,843	1,515,643	2,157	1,187,323	—	—
	10	月	Oct.	3,302	2,589,861	2,565	2,256,738	—	—
	11	月	Nov.	3,484	4,469,284	2,746	4,265,053	—	—
	12	月	Dec.	3,596	3,686,288	2,620	3,041,254	—	—

資料來源：根據本處財產稅科資料編製。

附 註：本表件數含應稅與免稅。

Table 10. Sources of Deed Tax

Unit : N.T.\$1,000

交換契 Exchange		贈與契 Donation		分割契 Division		占有契 Staking	
件數 Cases	契價 Deed Value	件數 Cases	契價 Deed Value	件數 Cases	契價 Deed Value	件數 Cases	契價 Deed Value
938	927,672	6,672	1,891,870	236	254,221	1	294
926	1,019,933	5,912	1,519,979	173	193,656	4	914
1,348	1,345,151	6,613	1,688,921	88	38,922	—	—
1,308	1,306,651	6,590	1,721,469	170	418,856	—	—
1,013	911,399	7,015	1,854,852	100	26,046	—	—
894	815,303	7,914	2,207,685	97	153,774	—	—
1,117	1,120,083	8,350	2,490,558	52	11,062	—	—
1,178	1,079,514	9,474	2,771,281	64	18,429	—	—
864	1,283,123	9,215	2,783,729	72	77,512	—	—
779	1,050,449	9,818	2,815,271	130	121,602	—	—
190	95,529	2,466	592,274	21	7,544	—	—
23	10,424	911	215,941	—	—	—	—
34	16,200	675	180,112	—	—	—	—
39	23,818	578	141,260	7	539	—	—
28	30,572	564	152,116	7	1,586	—	—
148	266,105	563	153,462	1	1,826	—	—
30	59,602	619	214,203	2	761	—	—
68	77,971	614	234,120	2	651	—	—
38	39,842	634	285,861	14	2,617	—	—
59	148,147	672	180,579	6	4,397	—	—
27	30,188	700	173,131	11	912	—	—
95	252,053	822	292,212	59	100,768	—	—

表 11 印花稅稅源 ①

單位：新臺幣千元

年 度 (月) 別 Fiscal Year (Month)	合 計① Total	出 售 印 花 稅 票 Taxes Stamps	總		
			金融業 Finance	保 險 業 Insurance	傳 播 業 Broadcasting
99 年 度 FY2010	4,061,562	565,080	1,138,041	575,952	2,035
100 年 度 FY2011	4,232,189	514,547	1,175,596	616,064	1,978
101 年 度 FY2012	4,466,450	477,820	1,182,223	684,628	1,926
102 年 度 FY2013	4,381,501	448,112	1,223,112	706,812	1,815
103 年 度 FY2014	4,559,596	481,664	1,294,717	747,219	1,837
1 月 Jan.	686,554	51,622	214,298	117,420	283
2 月 Feb.	110,106	30,527	—	0	—
3 月 Mar.	611,037	18,479	205,756	127,946	293
4 月 Apr.	87,611	25,905	0	3	—
5 月 May	622,278	26,951	219,759	121,392	318
6 月 June	130,854	48,835	20	—	—
7 月 July	687,502	60,391	218,891	127,296	353
8 月 Aug.	145,208	70,488	207	—	—
9 月 Sep.	631,567	42,425	216,737	135,594	307
10 月 Oct.	124,395	32,701	0	1	—
11 月 Nov.	607,482	44,265	219,048	117,566	280
12 月 Dec.	115,001	29,075	1	—	2

資料來源：根據本處機會稅科資料編製。

附 註：①101年以前為本年度實徵數，102年起為本年度實徵淨額。

Table 11. Sources of Stamp Tax ①

Unit : N.T.\$1,000

繳				Total Payment	違章補繳 Payment on Tax Evasion
公用事業 Utilities	承攬契據 Construction agreements	財產契據 Real Estate Deed	其他 Others		
22,504	391,806	330,777	1,035,364	3	
23,682	500,736	315,310	1,084,271	5	
23,304	629,040	283,867	1,183,611	31	
26,789	537,595	324,602	1,112,238	427	
16,084	609,806	309,045	1,098,995	230	
3,560	74,585	31,029	193,758	—	
—	60,235	18,564	780	—	
2,182	60,195	28,969	167,217	—	
—	36,041	25,211	451	—	
2,140	42,292	25,117	184,298	11	
—	55,646	22,668	3,684	—	
3,345	56,684	22,043	198,499	—	
—	49,315	23,432	1,767	—	
1,787	33,933	21,703	179,081	—	
—	56,847	30,102	4,739	4	
3,069	34,466	25,020	163,768	—	
—	49,568	35,187	953	215	

表 12 娛 樂 稅 稅 源 ①

金額單位：新臺幣元

年 度 (月) 別 Fiscal Year (Month)			合 計 Total		電 影 Movies	
			家 數 Unit	實 徵 稅 額 Net Amount Remitted	家 數 Unit	實 徵 稅 額 Net Amount Remitted
94	年 度	FY2005	2,308	242,087,524	44	47,458,117
95	年 度	FY2006	2,037	243,999,753	40	48,012,314
96	年 度	FY2007	1,859	197,243,270	38	46,686,982
97	年 度	FY2008	1,781	212,488,992	37	39,388,243
98	年 度	FY2009	1,718	210,022,962	33	42,732,259
99	年 度	FY2010	1,671	226,872,556	36	52,681,026
100	年 度	FY2011	1,677	243,807,447	36	60,653,547
101	年 度	FY2012	1,624	224,137,868	37	57,768,614
102	年 度	FY2013	1,615	228,927,370	37	61,062,114
103	年 度	FY2014	1,549	234,874,808	37	61,738,090
	1 月	Jan.	1,586	18,255,413	36	4,691,898
	2 月	Feb.	1,566	24,419,902	37	3,826,873
	3 月	Mar.	1,522	15,864,486	37	5,171,332
	4 月	Apr.	1,557	19,456,134	38	4,797,919
	5 月	May	1,567	16,375,778	37	4,543,974
	6 月	June	1,551	18,565,206	37	5,547,250
	7 月	July	1,567	23,311,578	37	5,998,233
	8 月	Aug.	1,539	20,589,179	37	5,876,908
	9 月	Sep.	1,550	22,701,917	37	7,477,727
	10 月	Oct.	1,642	13,902,695	37	4,153,217
	11 月	Nov.	1,553	22,798,022	37	4,758,557
	12 月	Dec.	1,549	18,634,498	37	4,894,202

資料來源：根據本處機會稅科資料編製。

附 註：①93年以前家數為實徵家數，實徵稅額為本年度實徵數；94年起家數為自動報繳及查定之家數，實徵稅額為實徵淨額。

②其他欄內包括臨時公演及夜總會、戲劇等。

Table 12. Sources of Amusement Tax ①

Unit : N.T.\$1

歌 廳 Sing Halls		撞 球 場 Billiards Halls		保 齡 球 Bowling Alleys	
家 數 Unit	實 徵 稅 額 Net Amount Remitted	家 數 Unit	實 徵 稅 額 Net Amount Remitted	家 數 Unit	實 徵 稅 額 Net Amount Remitted
—	—	98	3,529,103	5	778,196
1	36,493	85	3,121,034	5	714,498
1	72,420	3	1,533,854	—	389,013
1	72,420	—	125,365	—	—
1	72,180	—	49,682	—	—
1	72,300	—	42,342	—	—
1	75,908	—	57,915	—	—
1	72,420	—	—	—	—
1	72,420	—	—	—	—
2	128,120	—	—	—	—
1	6,035	—	—	—	—
1	6,035	—	—	—	—
1	6,035	—	—	—	—
1	6,035	—	—	—	—
1	6,035	—	—	—	—
1	6,035	—	—	—	—
1	6,035	—	—	—	—
1	6,035	—	—	—	—
3	45,585	—	—	—	—
2	13,617	—	—	—	—
2	8,932	—	—	—	—
2	11,706	—	—	—	—

表 12 娛 樂 稅 稅 源 ① (續)

金額單位：新臺幣元

年 度 (月) 別 Fiscal Year (Month)			高爾夫球練習場 Golf		舞廳 (場) Dance Halls		電子遊戲機 Electric Toys	
			家數 Unit	實徵稅額 Net Amount Remitted	家數 Unit	實徵稅額 Net Amount Remitted	家數 Unit	實徵稅額 Net Amount Remitted
94	年 度	FY2005	13	5,310,997	46	24,977,469	138	22,193,156
95	年 度	FY2006	13	3,846,895	42	22,974,644	111	9,239,571
96	年 度	FY2007	13	2,407,224	32	17,620,681	86	8,960,627
97	年 度	FY2008	14	-6,539,283	32	15,664,322	78	8,313,668
98	年 度	FY2009	14	3,003,059	27	13,659,294	78	6,683,071
99	年 度	FY2010	14	3,092,520	28	12,137,962	70	6,257,564
100	年 度	FY2011	14	3,510,075	26	10,112,917	68	5,801,330
101	年 度	FY2012	16	3,424,660	21	9,148,763	65	5,721,201
102	年 度	FY2013	19	3,250,593	22	10,243,677	53	5,101,660
103	年 度	FY2014	17	3,229,941	22	9,391,384	54	4,535,210
1	月	Jan.	19	333,883	21	856,027	54	314,186
2	月	Feb.	19	259,092	21	821,008	52	369,086
3	月	Mar.	18	232,828	21	753,138	54	369,690
4	月	Apr.	19	259,217	20	808,594	58	399,820
5	月	May	19	235,507	20	786,618	58	389,635
6	月	June	17	274,465	20	834,814	57	378,978
7	月	July	17	351,956	20	746,503	57	445,094
8	月	Aug.	17	257,311	20	767,063	57	337,483
9	月	Sep.	17	244,334	20	711,423	57	402,717
10	月	Oct.	17	248,062	20	804,352	55	381,807
11	月	Nov.	16	265,140	22	738,702	54	336,515
12	月	Dec.	17	268,146	22	763,142	54	410,199

Table 12. Sources of Amusement Tax ① (Cont.)

Unit : N.T.\$1

有節目餐飲業 Entertainment Restaurants		MTV等視聽業 MTV Audiovisual Services		其他② Others	
家數 Unit	實徵稅額 Net Amount Remitted	家數 Unit	實徵稅額 Net Amount Remitted	家數 Unit	實徵稅額 Net Amount Remitted
43	3,328,523	1,376	108,439,846	545	26,072,117
41	5,183,399	1,330	103,915,313	369	46,955,592
37	5,440,419	1,262	77,130,597	387	37,001,453
29	5,442,995	1,243	93,469,130	347	56,552,132
31	3,977,099	1,184	77,448,808	350	62,397,510
37	3,747,894	1,143	76,850,740	342	71,990,208
36	4,246,597	1,158	77,062,565	338	82,286,593
37	4,329,054	1,102	73,187,045	345	70,486,111
41	3,879,719	1,065	71,752,214	377	73,564,973
42	4,830,524	1,009	71,490,428	366	79,531,111
41	252,957	1,060	5,732,302	354	6,068,125
41	251,139	1,056	6,823,052	339	12,063,617
43	394,547	1,045	6,266,191	303	2,670,725
44	520,940	1,043	5,853,610	334	6,809,999
44	337,646	1,030	5,434,191	358	4,642,172
44	390,683	1,025	5,548,099	350	5,584,882
42	427,962	1,031	6,667,124	362	8,668,671
40	368,201	1,024	5,635,824	343	7,340,354
41	400,626	1,018	6,379,483	357	7,040,022
41	377,273	1,011	5,481,865	459	2,442,502
43	638,674	1,008	5,505,212	371	10,546,290
42	469,876	1,009	6,163,475	366	5,653,752

表 13 違章漏稅案件處理及財務罰鍰執行情形表

單位 { 件數：件
金額：新臺幣千元

年度及稅目別 Fiscal Year & Item of Tax	受理情形 No. of Cases Accepted			本期審理情形	
	合計 Total	上期未 結件數 Unclosed Cases of Last Term	本期受 理件數 Cases Accepted in this Term	依法免 議件數 Cases Not Indictable	依法免 罰件數 Fine Free Cases
94 年 度 FY2005	5,082	347	4,735	68	100
95 年 度 FY2006	3,909	61	3,848	80	105
96 年 度 FY2007	5,408	232	5,176	199	73
97 年 度 FY2008	6,799	143	6,656	368	36
98 年 度 FY2009	7,725	37	7,688	398	186
99 年 度 FY2010	14,445	147	14,298	576	2,976
100 年 度 FY2011	7,936	260	7,676	542	1,034
101 年 度 FY2012	6,042	72	5,970	382	726
102 年 度 FY2013	5,635	44	5,591	289	387
103 年 度 FY2014	3,597	61	3,536	221	268
土 地 稅 Land Tax	5	—	5	1	—
房 屋 稅 House Tax	—	—	—	—	—
使 用 牌 照 稅 Vehicle License Tax	3,572	55	3,517	215	263
契 稅 Deed Tax	—	—	—	—	—
印 花 稅 Stamp Tax	5	—	5	1	—
娛 樂 稅 Amusement Tax	15	6	9	4	5

資料來源：根據本處稅務管理科資料編製。

Table 13. The Management of Cases of Tax Evasion Against Law
and Execution Status of Fine

Unit: { Case
N.T.\$1,000

Cases Interrogated in This Term			本期繳納及移送情形 Cases of Find Paid and Transferred to Law Court in This Term					
處罰 Cases Fined		未結 件數 Cases Unclosed	合計 Total		自行繳納 Paid		移送執行 Transferred to Law Court	
件數 Cases	金額 Amount		件數 Cases	金額 Amount	件數 Cases	金額 Amount	件數 Cases	金額 Amount
4,853	98,832	61	3,342	82,690	3,303	78,801	39	3,889
3,492	59,977	232	3,867	82,339	3,053	53,577	814	28,762
4,993	110,999	143	5,351	93,588	3,070	36,461	2,281	57,127
6,358	187,241	37	6,649	141,108	3,567	56,162	3,082	84,946
6,994	142,501	147	9,527	177,289	2,991	56,029	6,536	121,260
10,633	230,263	260	13,542	253,119	4,703	42,138	8,839	210,981
6,288	101,053	72	13,282	213,703	4,897	31,559	8,385	182,144
4,890	81,560	44	11,727	178,053	4,092	23,740	7,635	154,313
4,898	68,455	61	11,152	162,532	3,543	27,326	7,609	135,206
3,080	49,005	28	7,755	131,268	1,671	11,301	6,084	119,967
4	52	—	4	103	3	39	1	64
—	—	—	—	—	—	—	—	—
3,066	47,614	28	7,742	130,279	1,661	10,771	6,081	119,508
—	—	—	—	—	—	—	—	—
4	127	—	4	353	3	107	1	246
6	1,212	—	5	533	4	384	1	149

表 13 違章漏稅案件處理及財務罰鍰執行情形表 (續)

單位 { 件數：件
金額：新臺幣千元

年度及稅目別 Fiscal Year & Item of Tax	更正註銷案件 Case of Revising or Cancelling		本 期	
			合計 Total	
	件 數 Cases	金 額 Amount	件 數 Cases	金 額 Amount
94 年 度 FY2005	- 295	15,072	186	8,609
95 年 度 FY2006	- 224	26,333	329	11,284
96 年 度 FY2007	- 305	10,162	1,106	31,902
97 年 度 FY2008	- 908	30,551	2,576	59,340
98 年 度 FY2009	-1,399	24,282	4,341	118,649
99 年 度 FY2010	-1,745	15,011	6,478	148,069
100 年 度 FY2011	-1,890	38,177	9,270	219,195
101 年 度 FY2012	-3,553	1,865	6,560	150,690
102 年 度 FY2013	6	33,485	6,996	136,684
103 年 度 FY2014	1,783	35,519	6,881	127,183
土 地 稅 Land Tax	—	—	1	64
房 屋 稅 House Tax	—	—	—	—
使 用 牌 照 稅 Vehicle License Tax	1,783	35,519	6,876	126,916
契 稅 Deed Tax	—	—	—	—
印 花 稅 Stamp Tax	—	—	1	36
娛 樂 稅 Amusement Tax	—	—	3	167

Table 13. The Management of Cases of Tax Evasion Against Law and Execution Status of Fine (Cont.)

Unit: { Case
N.T.\$1,000

執行情形 Cases Executed in This Term						截至本期未執行案件 Cases Unexecuted	
移送繳納 Fined Paid		發給執行憑證 Giving Executive Evidence		移送駁回或撤回 Cases of Withdrawn or Rejected			
件數 Cases	金額 Amount	件數 Cases	金額 Amount	件數 Cases	金額 Amount	件數 Cases	金額 Amount
72	5,145	84	2,335	30	1,129	1,083	569,716
147	6,671	175	4,364	7	249	1,568	587,194
388	12,275	675	17,291	43	2,336	2,743	612,419
813	17,424	1,695	39,871	68	2,045	3,249	638,025
1,405	26,010	2,829	90,581	107	2,058	5,444	640,636
1,750	31,268	4,584	113,901	144	2,900	7,805	703,548
2,118	41,503	7,019	173,858	133	3,834	5,866	180,815
1,816	32,995	4,616	114,427	128	3,268	6,941	184,438
1,938	29,024	4,976	105,960	82	1,700	7,554	182,960
1,877	28,647	4,927	97,115	77	1,421	6,304	165,557
1	64	—	—	—	—	1	10,895
—	—	—	—	—	—	—	—
1,874	28,544	4,925	96,951	77	1,421	6,296	134,893
—	—	—	—	—	—	—	—
1	36	—	—	—	—	5	19,724
1	3	2	164	—	—	2	45

表 14 各項稅捐滯納案件移送執行情形

金額單位：新臺幣元

年度及稅目別 Fiscal Year & Item of Tax	移送執行數① Executed cases		執行徵起數(1) Executive Levied Tax		掣發債權憑證數(2) Giving Executive Evidence	
	件數 Cases	金額 Amount	件數 Cases	金額 Amount	件數 Cases	金額 Amount
94 年度 FY2005	51,283	1,595,546,632	32,601	588,246,111	23,519	167,858,366
95 年度 FY2006	81,754	1,671,258,452	44,204	1,082,993,724	36,292	240,778,668
96 年度 FY2007	82,875	1,058,039,055	46,559	827,587,893	61,579	497,154,171
97 年度 FY2008	76,381	1,024,567,477	39,497	611,348,255	50,078	439,371,016
98 年度 FY2009	86,642	1,070,882,804	38,327	667,009,679	51,666	481,404,542
99 年度 FY2010	80,769	842,479,642	35,215	573,963,337	54,967	843,341,510
100 年度 FY2011	59,383	727,698,688	32,371	714,712,214	53,687	823,659,132
101 年度 FY2012	55,501	546,330,038	26,548	438,195,809	25,761	262,966,626
102 年度 FY2013	46,641	420,820,836	26,114	331,664,615	23,141	176,463,048
103 年度 FY2014	44,654	411,498,960	25,496	288,609,636	20,152	162,299,899
地價稅 Land Value Tax	10,812	109,981,580	7,467	97,452,043	3,375	25,133,096
土地增值稅 Land Value Increment Tax	5	8,859,940	1	4,599,868	8	18,052,892
房屋稅 House Tax	7,334	37,708,377	5,463	38,237,381	1,534	6,739,735
使用牌照稅 Vehicle License Tax	24,512	195,389,248	12,036	107,451,915	13,509	86,045,874
契稅 Deed Tax	16	370,282	8	118,825	6	266,416
印花稅 Stamp Tax	—	—	2	214,652	—	—
娛樂稅 Amusement Tax	1,975	6,169,903	519	1,922,405	1,720	5,060,858
罰鍰② Fine	—	53,019,630	—	38,612,547	—	21,001,028

資料來源：根據本處稅務管理科資料編製。

附註：①包括以前年度移送未執行結轉數。

②罰鍰係指本稅以外之短估金、滯(怠)報金、滯納金及加計利息等之合計數，為附加稅，故不計件數。

③101年度以前係指結案數。

Table 14. The Status of Delayed Case Transferred to Execution

Unit : N.T.\$1

撤退案數(3)		稅捐處清理數③(1+2+3=4)		移送尚未執行數	
Cases of Withdrawn		Closed Cases		Unexecuted Cases	
件數 Cases	金額 Amount	件數 Cases	金額 Amount	件數 Cases	金額 Amount
4,248	282,299,009	60,368	1,038,403,486	151,141	3,993,496,359
4,074	176,829,888	84,570	1,500,602,280	144,239	3,996,599,528
3,946	101,388,745	112,084	1,426,130,809	111,010	3,564,275,012
2,338	104,810,618	91,913	1,155,529,889	92,189	3,380,106,899
1,977	35,843,492	91,970	1,184,257,713	83,718	3,209,836,714
1,851	24,838,280	92,033	1,442,143,127	70,335	2,560,047,010
933	15,260,562	86,991	1,553,631,908	41,370	1,603,167,185
1,017	14,761,965	53,326	715,924,400	42,845	1,395,183,086
520	6,656,743	49,775	514,784,406	4,307	151,801,244
318	3,398,005	45,966	454,307,540	36,989	1,234,841,497
71	1,237,144	10,913	123,822,283	8,382	420,028,836
—	—	9	22,652,760	14	348,075,964
28	241,756	7,025	45,218,872	6,220	124,553,755
202	1,434,450	25,747	194,932,239	20,347	153,284,479
—	—	14	385,241	7	333,128
—	—	2	214,652	—	—
17	51,902	2,256	7,035,165	2,019	5,847,905
—	432,753	—	60,046,328	—	182,717,430

表 15 查(核)定開徵數及未徵數情形

單位 { 件數：件
金額：新臺幣千元

一. 本年度

年度及稅目別 Fiscal Year & Item of Tax	查(核)定開徵數 Opening Collection for Assessed(Verified) (1)		實徵數 Tax Collected (2)		減免註銷數 Cancelled (3)		逾徵收 期限數 Overdue (4)	
	件數 Cases	金額 Amount	件數 Cases	金額 Amount	件數 Cases	金額 Amount	件數 Cases	金額 Amount
99 年度 FY2010	3,025,499	62,977,206	2,903,255	59,320,680	44,195	1,964,206	1	2
100 年度 FY2011	3,008,150	63,464,263	2,912,650	59,970,637	29,434	2,144,176	—	—
101 年度 FY2012	3,041,661	64,291,613	2,950,791	60,881,995	23,796	1,568,405	—	—
102 年度 FY2013	3,061,761	68,463,016	2,974,908	64,981,290	25,022	2,069,634	—	—
103 年度 FY2014	3,098,137	70,702,817	3,005,973	66,230,222	32,645	3,324,245	—	—
地價稅 Land Value Tax	883,415	22,873,146	850,043	22,125,335	1,779	312,553	—	—
土地增值稅 Land Value Increment Tax	69,181	21,997,545	64,125	19,066,215	4,078	2,492,328	—	—
房屋稅 House Tax	1,033,296	12,297,524	1,022,571	12,093,854	3,447	113,377	—	—
使用牌照稅 Vehicle License Tax	941,989	7,405,768	911,478	7,040,295	17,618	268,264	—	—
契稅 Deed Tax	45,246	1,768,012	43,132	1,641,732	1,673	98,249	—	—
印花稅 Stamp Tax	101,848	4,070,077	94,775	4,014,182	3,525	34,458	—	—
娛樂稅 Amusement Tax	19,701	236,631	18,357	232,634	351	48	—	—
罰鍰 Fine	3,461	54,116	1,492	15,976	174	4,967	—	—

資料來源：根據本處稅務管理科資料編製。

附註：1.本表以開徵始日為統計基礎。

2.實徵數之件數及金額未包含實徵當查定部分。

Table 15. The Management of Opening Collection for Assessed (Verified) and of Tax Not Collected

Unit: $\begin{cases} \text{Case} \\ \text{N.T.}\$1,000 \end{cases}$

1. Current Year

逾核課期限數 Excess Assessment (5)		未徵數餘額 Balance of Tax Not Collected					
		合計 Total (6)=(1)-(2)-(3)-(4)-(5)		繳款書未送達 未徵數 Have Not Been Served the Payment Notice		未逾限繳日 未徵數 Have Not Exceeded the Deadline of Payment	
件數 Cases	金額 Amount	件數 Cases	金額 Amount	件數 Cases	金額 Amount	件數 Cases	金額 Amount
100	839	77,948	1,691,479	31,294	606,350	21,096	615,821
14	55	66,052	1,349,395	28,618	487,570	16,925	501,801
15	49	67,059	1,841,163	29,703	881,553	19,519	561,446
13	58	61,818	1,412,034	28,370	668,134	15,015	430,539
9	141	59,510	1,148,209	27,334	299,768	14,530	499,542
6	57	31,587	435,201	25,635	170,371	5,177	108,669
—	—	978	439,002	319	121,091	650	317,183
—	—	7,278	90,292	658	3,220	2,147	15,144
2	9	12,891	97,201	393	2,537	2,527	9,517
—	—	441	28,031	59	1,625	381	26,405
—	—	3,548	21,437	123	638	3,425	20,799
—	—	993	3,949	144	250	206	1,318
1	76	1,794	33,097	3	36	17	507

表 15 查(核)定開徵數及未徵數情形 (續1)

單位 { 件數：件
金額：新臺幣千元

一.本年度

年度及稅目別 Fiscal Year & Item of Tax	未徵數餘額							
	行政救濟 未徵數 Administrative Remedies		分期繳納 未徵數 Pay by Stages		特殊原因 未徵數 Special Reason		欠	
							小計	
	件數 Cases	金額 Amount	件數 Cases	金額 Amount	件數 Cases	金額 Amount	件數 Cases	金額 Amount
99 年度 FY2010	385	100,132	—	—	943	191	24,230	368,986
100 年度 FY2011	138	28,466	—	—	462	81	19,909	331,478
101 年度 FY2012	199	154,138	—	—	187	97	17,451	243,929
102 年度 FY2013	96	70,784	—	—	232	124	18,105	242,454
103 年度 FY2014	89	115,982	—	—	231	230	17,326	232,689
地 價 稅 Land Value Tax	53	65,939	—	—	24	91	698	90,130
土 地 增 值 稅 Land Value Increment Tax	4	405	—	—	—	—	5	323
房 屋 稅 House Tax	29	49,425	—	—	141	26	4,303	22,477
使 用 牌 照 稅 Vehicle License Tax	2	13	—	—	57	109	9,912	85,025
契 稅 Deed Tax	—	—	—	—	—	—	1	1
印 花 稅 Stamp Tax	—	—	—	—	—	—	—	—
娛 樂 稅 Amusement Tax	—	—	—	—	7	1	636	2,380
罰 鍰 Fine	1	200	—	—	2	2	1,771	32,352

Table 15. The Management of Opening Collection for Assessed (Verified) and of Tax Not Collected (Cont.1)

Unit: $\left\{ \begin{array}{l} \text{Case} \\ \text{N.T. \$1,000} \end{array} \right.$

1. Current Year							
Balance of Tax Not Collected							
稅		數		Pending Tax Arrears			
送達未逾滯納期 Service of Notice Has Not Exceeded Delinquency Period		移送執行未結 Transferred to Law Court Not Yet Closed		執行憑證數 Executive Evidence		其他 Others	
件數 Cases	金額 Amount	件數 Cases	金額 Amount	件數 Cases	金額 Amount	件數 Cases	金額 Amount
3,381	30,033	14,261	170,109	2,144	24,500	4,444	144,343
2,379	38,893	11,643	108,743	1,897	16,956	3,990	166,886
2,896	26,988	10,106	93,600	824	7,616	3,625	115,725
2,021	16,523	11,911	104,187	603	5,041	3,570	116,703
1,909	71,693	12,504	111,676	1,007	9,670	1,906	39,649
267	59,637	86	694	—	—	345	29,799
—	—	—	—	—	—	5	323
555	2,705	3,097	17,630	16	19	635	2,123
1,020	9,118	7,523	65,623	559	3,403	810	6,881
1	1	—	—	—	—	—	—
—	—	—	—	—	—	—	—
61	151	414	1,857	75	217	86	154
5	81	1,384	25,873	357	6,031	25	368

表 15 查(核)定開徵數及未徵數情形 (續2)

單位 { 件數：件
金額：新臺幣千元

二. 以前年度

年度及稅目別 Fiscal Year & Item of Tax	查(核)定開徵數①		實徵數		減免註銷數		逾徵收 期限數	
	Opening Collection for Assessed(Verified) (1)		Tax Collected (2)		Cancelled (3)		Overdue (4)	
	件數 Cases	金額 Amount	件數 Cases	金額 Amount	件數 Cases	金額 Amount	件數 Cases	金額 Amount
99 年度 FY2010	235,711	4,934,146	98,006	1,424,320	1,372	227,162	19,741	406,871
100 年度 FY2011	220,787	4,341,814	93,336	1,752,666	6,370	113,053	17,745	388,801
101 年度 FY2012	184,058	3,393,966	76,631	1,306,722	1,214	61,911	17,482	204,789
102 年度 FY2013	168,974	3,016,747	76,703	1,146,773	478	75,169	13,596	117,944
103 年度 FY2014	149,916	2,911,044	69,114	947,241	-861	81,493	14,123	120,263
地價稅 Land Value Tax	52,368	991,895	34,856	395,025	65	58,839	1,631	12,866
土地增值稅 Land Value Increment Tax	1,210	894,362	950	236,900	153	21,799	4	4,197
房屋稅 House Tax	13,967	245,822	7,925	127,688	98	-1,089	838	4,957
使用牌照稅 Vehicle License Tax	56,739	331,986	17,282	78,523	-1,650	-3,101	9,364	64,153
契稅 Deed Tax	530	16,239	450	14,319	66	1,345	3	41
印花稅 Stamp Tax	3,954	67,486	3,625	65,293	313	1,902	—	—
娛樂稅 Amusement Tax	4,582	12,721	835	2,444	19	-55	670	2,078
罰鍰 Fine	16,566	350,534	3,191	27,050	75	1,853	1,613	31,971

資料來源：根據本處稅務管理科資料編製。

附註：①係原開徵始日在上年度12月31日以前之查(核)定開徵稅款，未逾徵收期間而仍未徵起者。

Table 15. The Management of Opening Collection for Assessed (Verified) and of Tax Not Collected (Cont.2)

Unit: $\begin{cases} \text{Case} \\ \text{N.T. \$1,000} \end{cases}$

逾核課期限數 Excess Assessment (5)		2. Previous Year 未徵數餘額 Balance of Tax Not Collected					
		合計 Total (6)=(1)-(2)-(3)-(4)-(5)		繳款書未送達 未徵數 Have Not Been Served the Payment Notice		未逾限繳日 未徵數 Have Not Exceeded the Deadline of Payment	
件數 Cases	金額 Amount	件數 Cases	金額 Amount	件數 Cases	金額 Amount	件數 Cases	金額 Amount
867	8,942	115,725	2,866,850	1,096	65,705	494	12,452
918	12,931	102,418	2,074,364	994	41,979	318	5,219
691	8,148	88,040	1,812,398	695	25,858	271	9,926
295	4,124	77,902	1,672,737	672	63,134	157	2,656
282	10,341	67,258	1,751,706	721	47,788	275	234,801
204	9,666	15,612	515,498	606	10,151	73	1,054
—	—	103	631,466	29	36,911	52	232,460
2	2	5,104	114,264	12	28	8	45
73	587	31,670	191,824	59	542	140	1,227
—	—	11	535	—	—	—	—
—	—	16	291	14	149	—	—
1	0	3,057	8,254	—	—	1	1
2	86	11,685	289,574	1	7	1	15

表 15 查(核)定開徵數及未徵數情形 (續3完)

單位 { 件數：件
金額：新臺幣千元

二.以前年度

年度及稅目別 Fiscal Year & Item of Tax	未徵數餘額							
	行政救濟 未徵數 Administrative Remedies		分期繳納 未徵數 Pay by Stages		特殊原因 未徵數 Special Reason		欠	
							小計	
	件數 Cases	金額 Amount	件數 Cases	金額 Amount	件數 Cases	金額 Amount	件數 Cases	金額 Amount
99 年度 FY2010	188	92,849	—	—	4,676	14,076	109,271	2,681,767
100 年度 FY2011	87	48,158	—	—	5,127	17,124	95,892	1,961,883
101 年度 FY2012	66	107,657	—	—	4,702	20,447	82,306	1,648,510
102 年度 FY2013	206	64,554	—	—	4,512	24,114	72,264	1,517,626
103 年度 FY2014	197	37,379	—	—	3,713	20,956	62,352	1,410,783
地 價 稅 Land Value Tax	11	32,658	—	—	1,808	19,595	13,114	452,041
土 地 增 值 稅 Land Value Increment Tax	4	163	—	—	—	—	18	361,932
房 屋 稅 House Tax	176	2,413	—	—	421	78	4,487	111,700
使 用 牌 照 稅 Vehicle License Tax	4	21	—	—	1,440	1,059	30,027	188,976
契 稅 Deed Tax	—	—	—	—	—	—	11	535
印 花 稅 Stamp Tax	1	142	—	—	1	0	—	—
娛 樂 稅 Amusement Tax	—	—	—	—	29	5	3,027	8,248
罰 鍰 Fine	1	1,982	—	—	14	219	11,668	287,351

Table 15. The Management of Opening Collection for Assessed (Verified) and of Tax Not Collected (Cont.3 End)

2. Previous Year

Unit: { Case
N.T.\$1,000

Balance of Tax Not Collected							
Pending Tax Arrears							
稅 數		移送執行未結		執行憑證數		其 他	
送達未逾滯納期 Service of Notice Has Not Exceeded Delinquency Period		Transferred to Law Court Not Yet Closed		Executive Evidence		Others	
件數 Cases	金額 Amount	件數 Cases	金額 Amount	件數 Cases	金額 Amount	件數 Cases	金額 Amount
146	1,392	31,026	1,889,076	77,567	769,787	532	21,512
115	881	20,254	1,219,373	75,114	723,418	409	18,210
65	361	14,602	1,001,966	67,306	635,422	333	10,761
30	364	14,025	952,511	58,119	563,693	Ⓔ181	Ⓔ1,711
66	584	13,012	912,598	49,093	496,408	181	1,193
38	402	5,342	382,240	7,637	68,347	97	1,051
—	—	11	347,664	7	14,268	—	—
3	21	2,127	100,040	2,333	11,588	24	52
20	123	3,829	29,606	26,146	159,160	32	88
—	—	1	233	10	302	—	—
—	—	—	—	—	—	—	—
2	4	312	1,340	2,712	6,904	1	0
3	34	1,390	51,474	10,248	235,840	27	2

表 16 各項稅捐現行稅率表

稅別	課 徵 標 的 及 稅 率			
地 價 稅	地價稅累進起點地價，以本市土地 7 公畝之平均地價為準。但不包括工業用地、礦業用地、農業用地及免稅土地在內。			
	土地類別	級別	累 進 地 價 級 距	稅 率
	私 有 一 般 土 地	1	未超過累進起點地價部分	10 ‰
		2	超過累進起點地價未達 5 倍者，其超過部分	15 ‰
		3	超過累進起點地價 5 倍至 10 倍者，其超過部分	25 ‰
		4	超過累進起點地價 10 倍至 15 倍者，其超過部分	35 ‰
		5	超過累進起點地價 15 倍至 20 倍者，其超過部分	45 ‰
		6	超過累進起點地價 20 倍以上者，其超過部分	55 ‰
	公 有 土 地			10 ‰
	工 業 或 礦 業 用 地			10 ‰
公 共 設 施 保 留 地			6 ‰	
自 用 住 宅 、 國 民 住 宅 及 勞 工 宿 舍 用 地			2 ‰	

表 16 各項稅捐現行稅率表（續 1）

稅別	稅級別	計 算 公 式
土 地 增 值 稅	第一級	應徵稅額＝土地漲價總數額〔超過原規定地價或前次移轉時申報現值（按臺灣地區消費者物價總指數調整後）未達百分之一百者〕×稅率（20%）。
	第二級	<p>應徵稅額＝土地漲價總數額【超過原規定地價或前次移轉時申報現值（按臺灣地區消費者物價總指數調整後）在百分之一百以上未達百分之二百者】×【稅率（30%）－〔（30%－20%）×減徵率〕】－累進差額（按臺灣地區消費者物價總指數調整後之原規定地價或前次移轉現值×A）。</p> <p>註：持有土地年限未超過 20 年者，無減徵，A 為 0.10。 持有土地年限超過 20 年以上者，減徵率為 20%，A 為 0.08。 持有土地年限超過 30 年以上者，減徵率為 30%，A 為 0.07。 持有土地年限超過 40 年以上者，減徵率為 40%，A 為 0.06。</p>
	第三級	<p>應徵稅額＝土地漲價總數額【超過原規定地價或前次移轉時申報現值（按臺灣地區消費者物價總指數調整後）在百分之二百以上者】×【稅率（40%）－〔（40%－20%）×減徵率〕】－累進差額（按臺灣地區消費者物價總指數調整後之原規定地價或前次移轉現值×B）。</p> <p>註：持有土地年限未超過 20 年者，無減徵，B 為 0.30。 持有土地年限超過 20 年以上者，減徵率為 20%，B 為 0.24。 持有土地年限超過 30 年以上者，減徵率為 30%，B 為 0.21。 持有土地年限超過 40 年以上者，減徵率為 40%，B 為 0.18。</p>
		自用住宅用地稅率一律 10%

表 16 各項稅捐現行稅率表 (續 2)

稅別	課 徵 標 的	稅 率
房 屋 稅	一、住家用房屋：	
	(一)供自住或公益出租人出租使用，按其房屋現值課徵。	1.2 %
	(二)持有本市非自住之其他住家用房屋在 2 戶以下者，按其房屋現值課徵。	2.4 %
	(三)持有本市非自住之其他住家用房屋在 3 戶以上者，按其房屋現值課徵。	3.6 %
	(四)公有房屋供住家使用，除法規另有規定外，一律按其房屋現值課徵。	1.5 %
	二、非住家用房屋：	
	(一)供營業、私人醫院、診所或自由職業事務所使用，按其房屋現值課徵。	3 %
	(二)供人民團體及其他性質可認定為非供營業用，按其房屋現值課徵。	2 %
	三、房屋同時作住家及非住家用者，應以實際使用面積分別按住家用或非住家用稅率，課徵房屋稅，但非住家用者，課稅面積最低不得少於全部面積六分之一。	
	四、房屋之使用執照所載用途別為停車場或防空避難室，未經核准變更使用，而改變為其他用途者：	
(一)住家用房屋按其房屋現值課徵。	3.6 %	
(二)非住家用房屋：		
1.非住家非營業用按其房屋現值課徵。	2.5 %	
2.營業用、私人醫院、診所或自由職業事務所使用按其房屋現值課徵。	5 %	
五、房屋空置不為使用，應按其現值依據使用執照所載用途或都市計畫分區使用範圍認定，分別以非自住之其他住家用房屋或非住家用房屋稅率課徵。		

表 16 各項稅捐現行稅率表 (續 3)

稅別	稅額 (元) 總排量 (立方公分)	車輛 種類	小客車		大客車	貨車	機器腳踏車
			自用	營業	全年	全年	全年
			全年	全年			
使 用 牌 照 稅	150 以下		—	—	—	—	0
	151~ 250		—	—	—	—	800
	251~ 500		1,620	900	—	900	1,620
	501~ 600		2,160	1,260	1,080	1,080	2,160
	601~ 1,200		4,320	2,160	1,800	1,800	4,320
	1,201~ 1,800		7,120	3,060	2,700	2,700	7,120
	1,801~ 2,400		11,230	6,480	3,600	3,600	(1801c.c.以上)11,230
	2,401~ 3,000		15,210	9,900	4,500	4,500	
	3,001~ 3,600	}	28,220	16,380	5,400	5,400	
	3,601~ 4,200				6,300	6,300	
	4,201~ 4,800	}	46,170	24,300	7,200	7,200	
	4,801~ 5,400				8,100	8,100	
	5,401~ 6,000	}	69,690	33,660	9,000	9,000	
	6,001~ 6,600				9,900	9,900	
	6,601~ 7,200	}	117,000	44,460	10,800	10,800	
	7,201~ 7,800				11,700	11,700	
7,801~ 8,400	}	151,200	56,700	12,600	12,600		
8,401~ 9,000				13,500	13,500		
9,001~ 9,600				14,400	14,400		
9,601~ 10,200				15,300	15,300		
10,201 以上				16,200	16,200		

臨時牌照	
車別	每日稅額
小客車	41
大客車	23
貨車	22
曳引車	28
機器腳踏車	5

試車牌照	
車別	每日稅額
小客車	414
機器腳踏車	30

附註：1. 曳引車之稅額按貨車稅額加徵 30%。

2. 小客貨兩用車之稅額按自用小客車之稅額課徵。

3. 自用車全年 1 期，營業車全年分上、下 2 期課徵。

表 16 各項稅捐現行稅率表 (續 4)

稅別	車輛種類	稅額 (元)		用途	
		馬達最大馬力		自用	營業
		英制馬力(HP)	公制馬力(PS)		
使 用 牌	完全以電能為動力之電動小客車 (每車乘人座位 9 人以下者)	38 以下	38.6 以下	1,620	900
		38.1~ 56	38.7~ 56.8	2,160	1,260
		56.1~ 83	56.9~ 84.2	4,320	2,160
		83.1~182	84.3~184.7	7,120	3,060
		182.1~262	184.8~265.9	11,230	6,480
		262.1~322	266.0~326.8	15,210	9,900
		322.1~414	326.9~420.2	28,220	16,380
		414.1~469	420.3~476.0	46,170	24,300
		469.1~509	476.1~516.6	69,690	33,660
		509.1 以上	516.7 以上	117,000	44,460
照 稅	完全以電能為動力之電動機器腳踏車	12 以下	12.2 以下		0
		12.1-20	12.3-20.3		800
		20.1-45	20.4-45.7		1,620

附註：臺北市政府於 104 年 3 月 3 日公告，本市完全以電能為動力之電動汽車，自 101 年 1 月 6 日起至 107 年 1 月 5 日止免徵使用牌照稅，期滿後自 107 年 1 月 6 日起恢復課稅。

表 16 各項稅捐現行稅率表 (續 5)

稅別	課 徵 標 的	稅 率
娛 樂 稅	一、舞廳、舞場	25 %
	二、電影	
	1. 外國語片 { (1)市區繁榮地帶	2.5 %
	(2)市區偏僻地帶	1.5 %
	(3)郊區	1 %
	2. 本國語片 { (1)市區繁榮地帶	1 %
	(2)市區偏僻地帶	1 %
	(3)郊區	1 %
	三、高爾夫球練習場	2.5 %
	四、職業性歌唱、舞蹈、馬戲、魔術、技藝表演及夜總會之各種表演。	5 %
五、各種競技比賽及其他提供娛樂設施供人娛樂者。	2.5 %	
六、說書、戲劇、音樂演奏及非職業性歌唱、舞蹈等表演。	1.25 %	
契 稅	一、買賣契按契價	6 %
	二、典權契按契價	4 %
	三、交換契按契價	2 %
	四、贈與契按契價	6 %
	五、分割契按契價	2 %
	六、占有契按契價	6 %

表 17 各項稅捐劃解分配率

103 年度

單位：百分比

稅目	繳庫別	
	國	庫
地價稅	—	100
土地增值稅	—	100
房屋稅	—	100
使用牌照稅	—	100
契稅	—	100
印花稅	—	100
娛樂稅	—	100

表 18 本處各項稅捐稽徵工作流程圖

(一)地 價 稅



表 18 本處各項稅捐稽徵工作流程圖 (續 1)
(二)土地增值稅



表 18 本處各項稅捐稽徵工作流程圖 (續 2)

(三)房 屋 稅

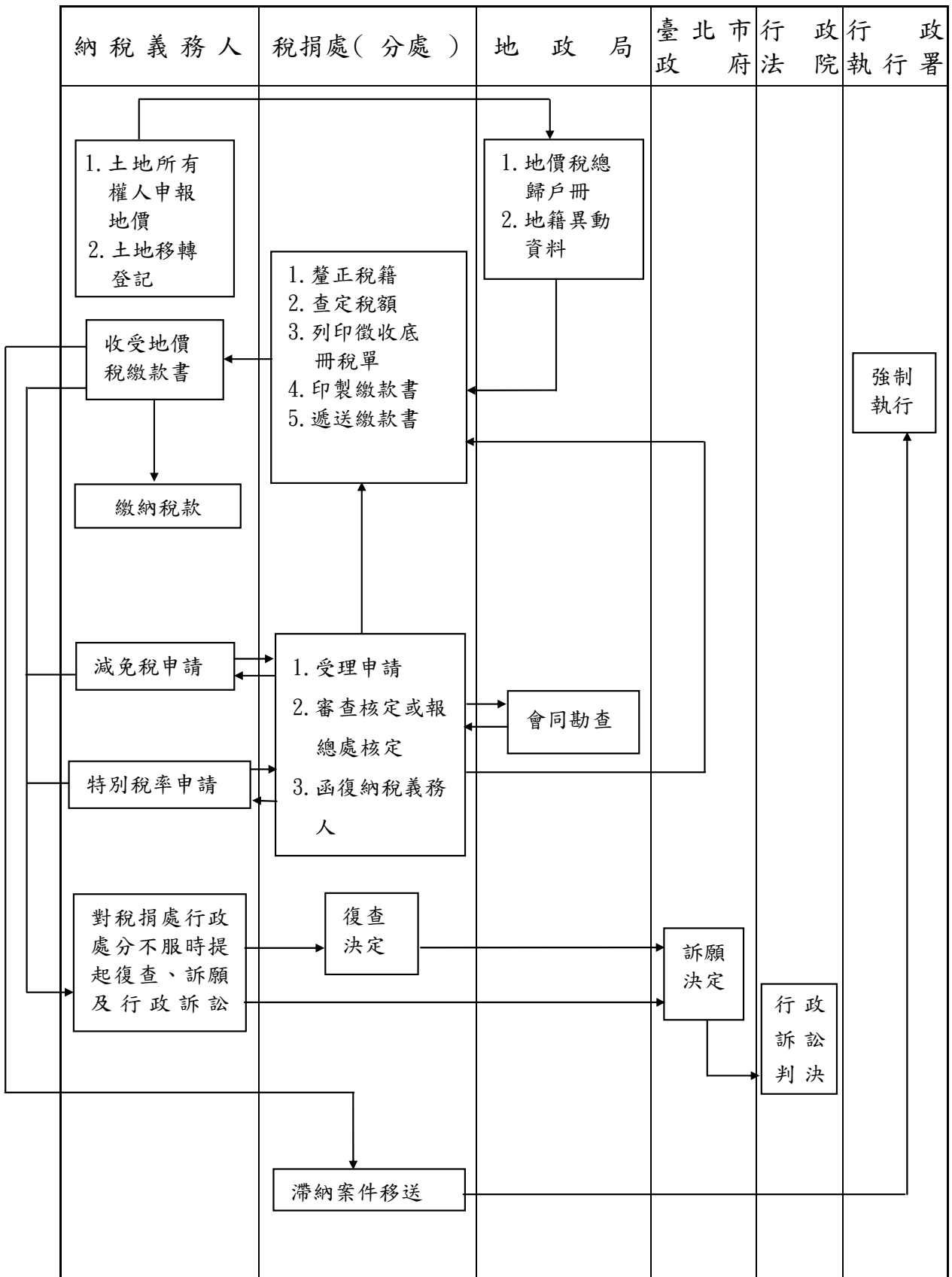

表 18 本處各項稅捐稽徵工作流程圖（續 3）

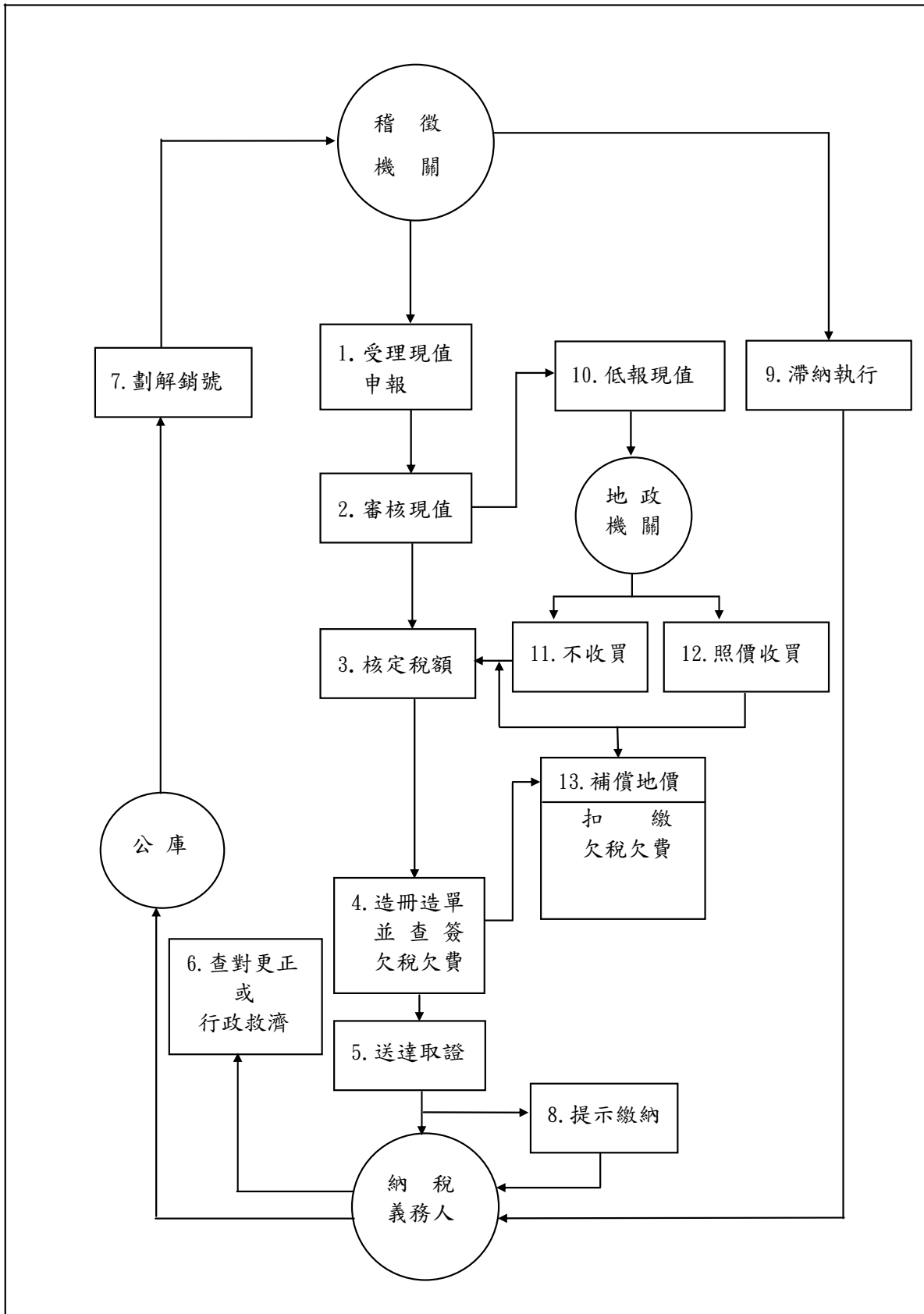
(四)使用牌照稅



表 18 本處各項稅捐稽徵工作流程圖 (續 4)
(五)契 稅

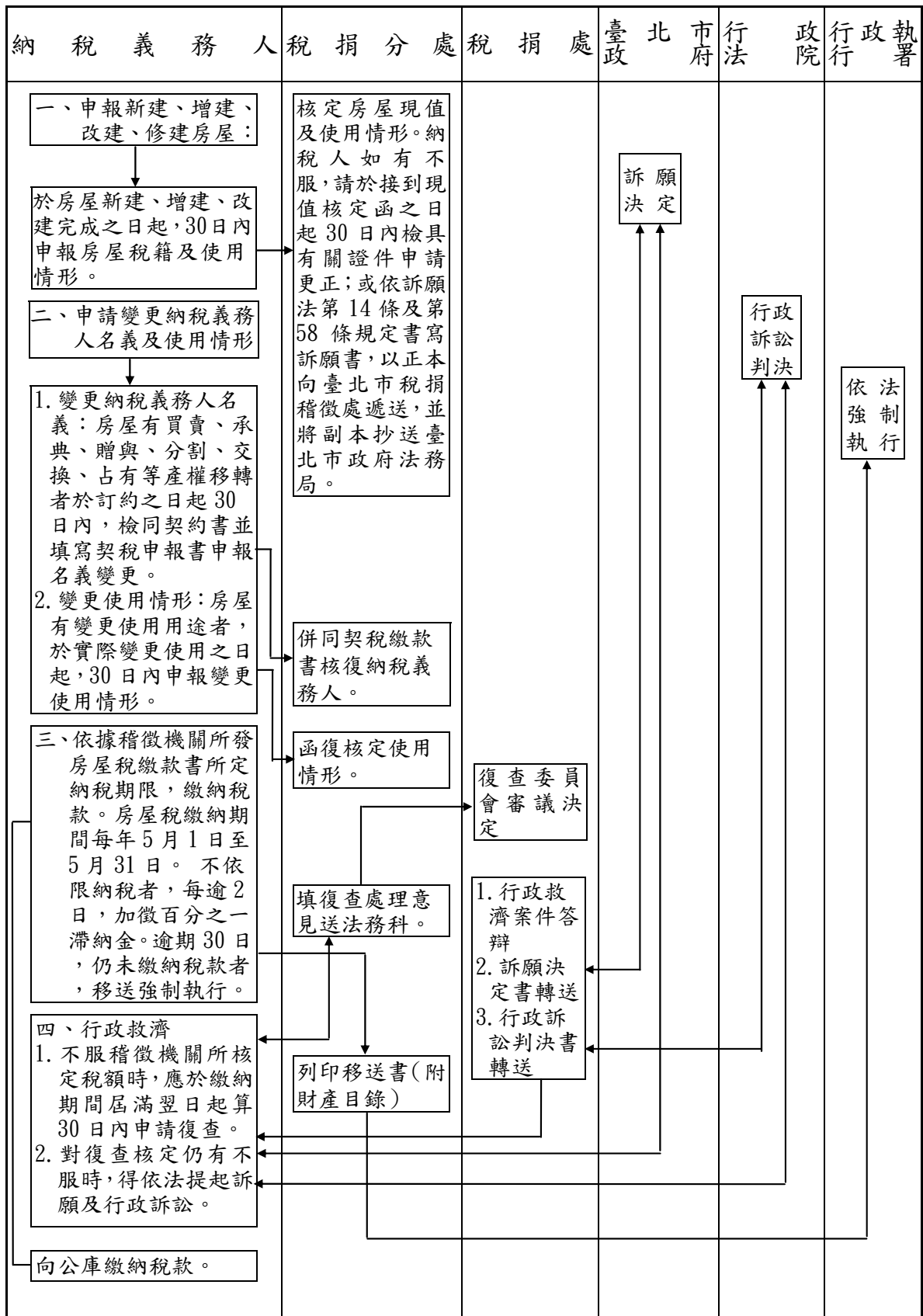

表 18 本處各項稅捐稽徵工作流程圖 (續 5)
(六)印 花 稅

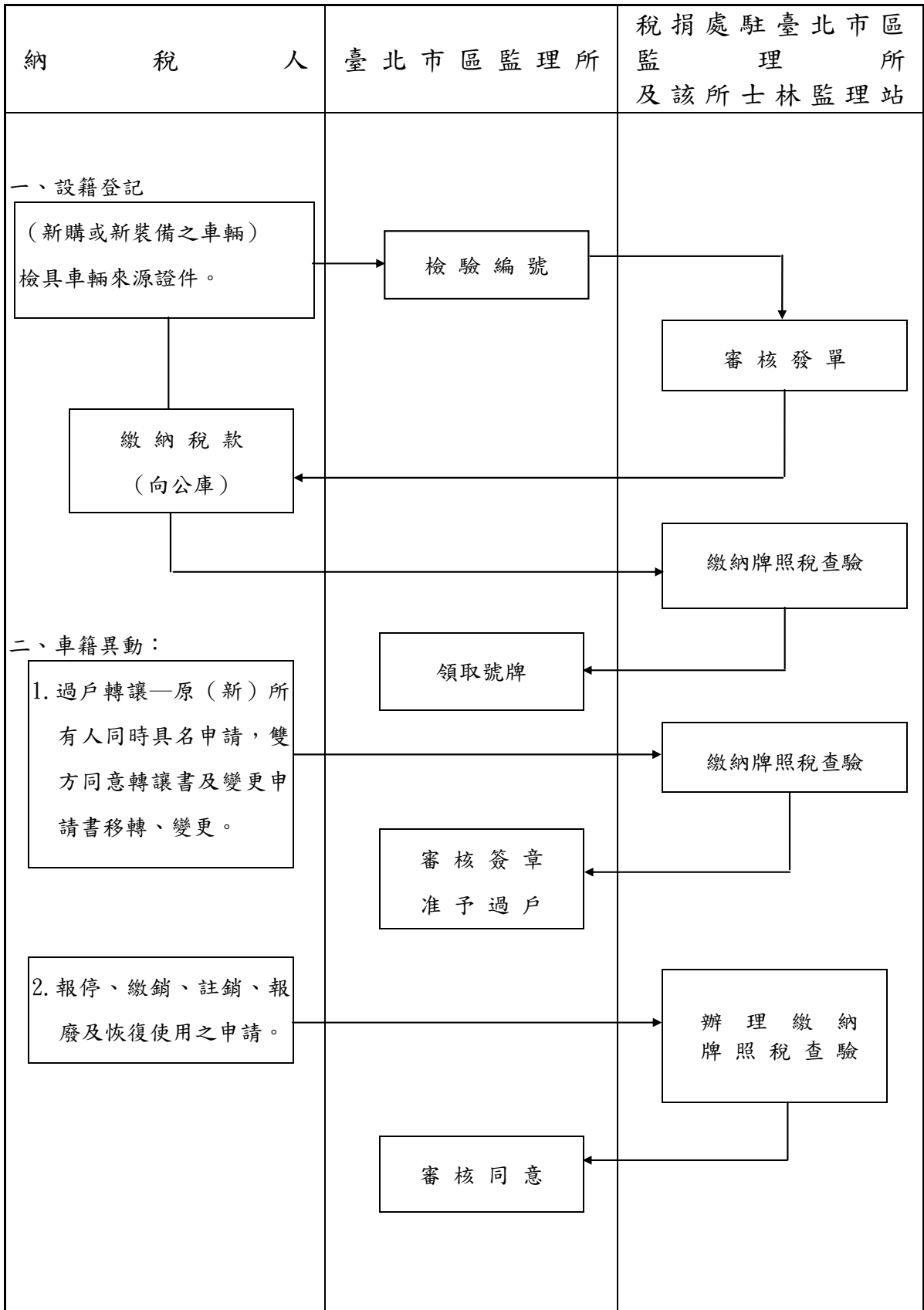

表 18 本處各項稅捐稽徵工作流程圖 (續 7 完)
(八) 支票退稅

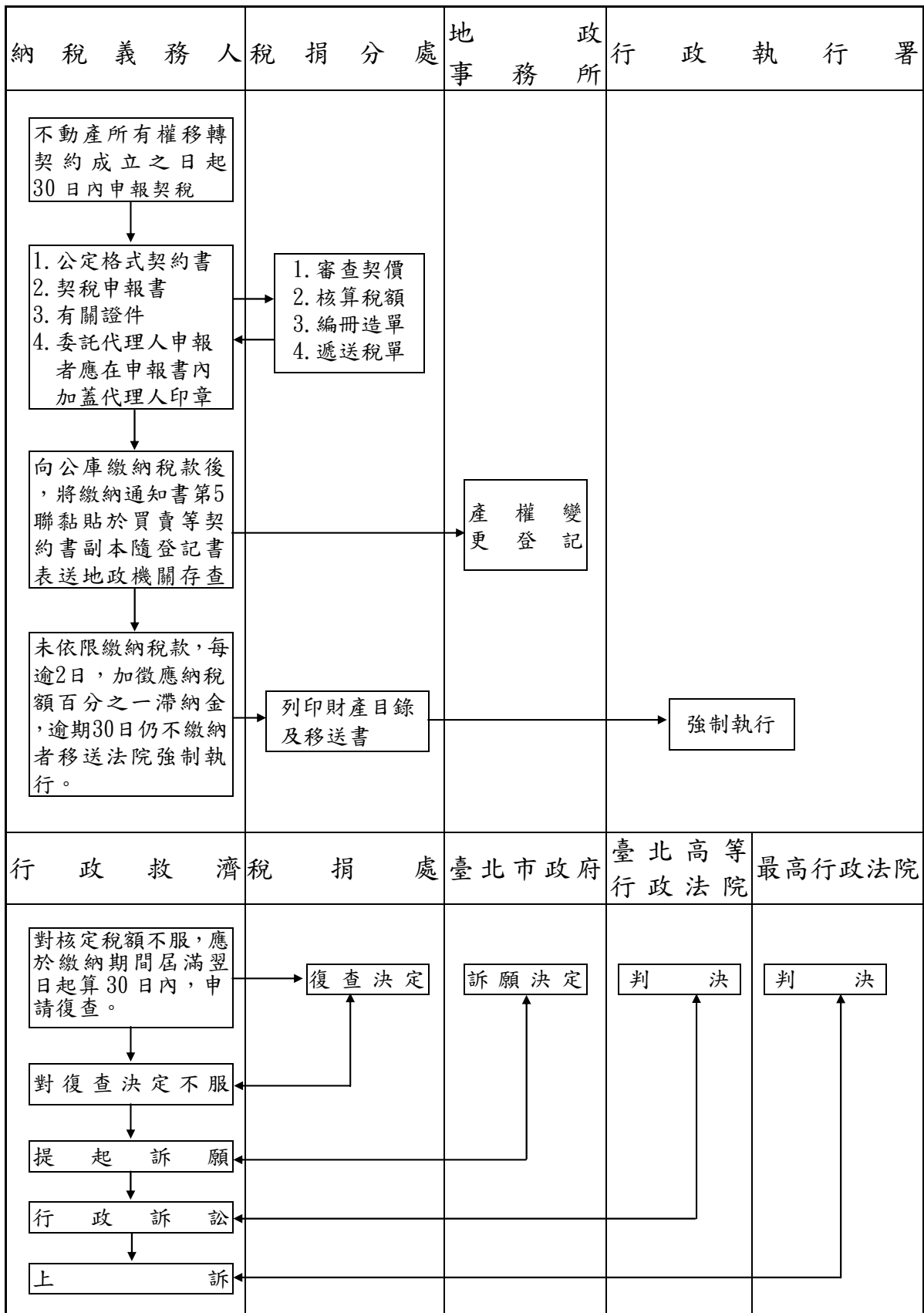

肆、行政組織

IV . Administrative Organization

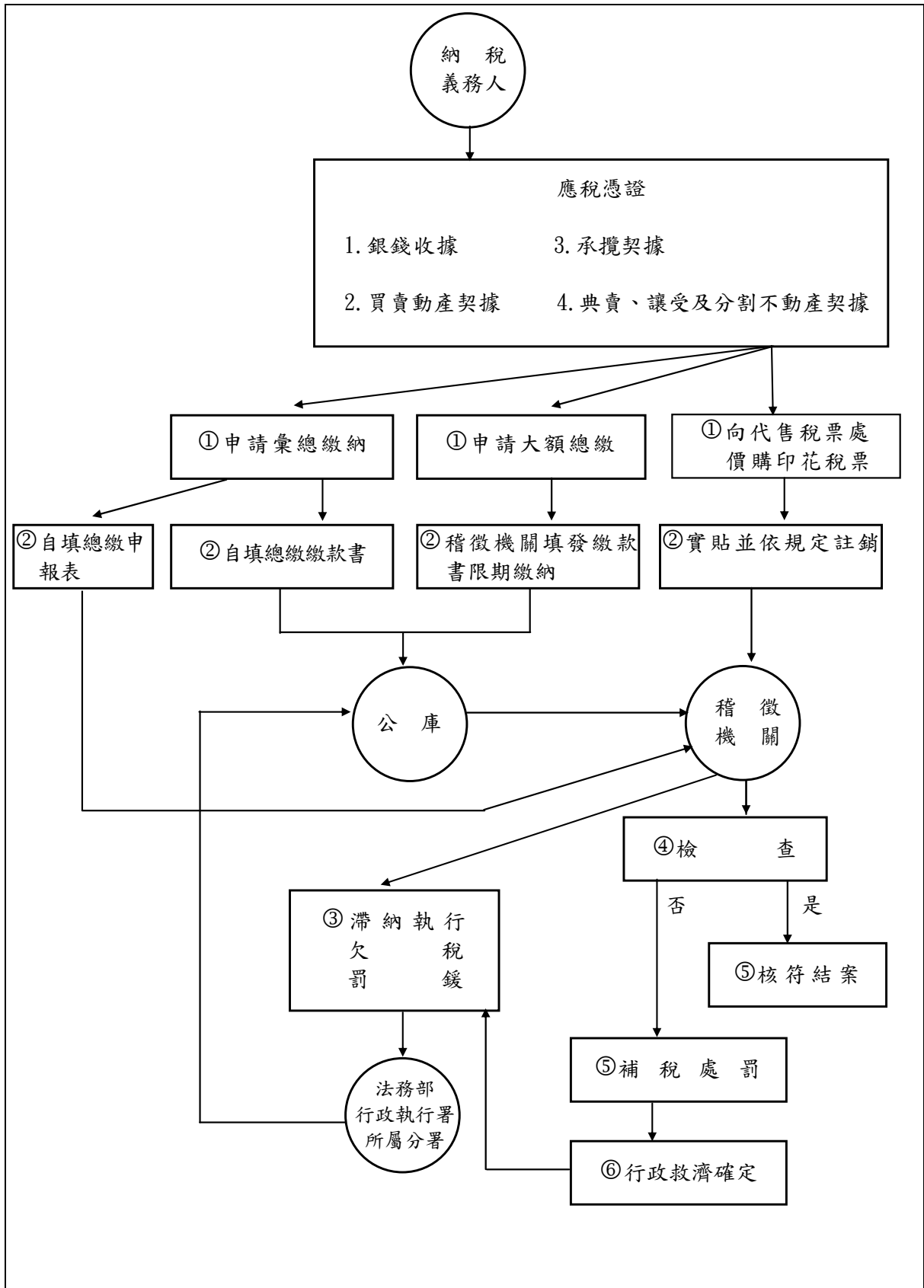
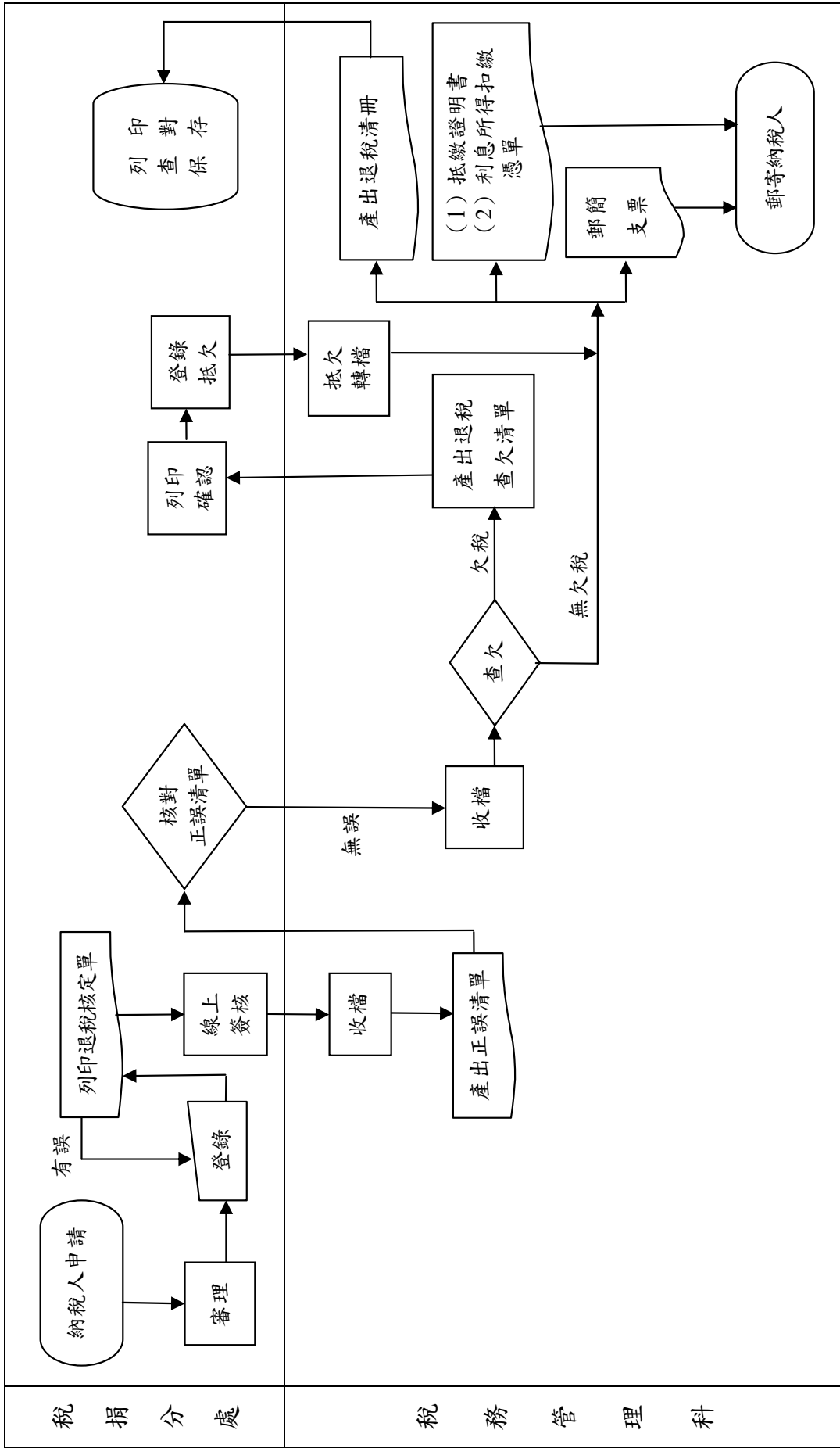
一、沿革

民國 34 年全省實施統一稽徵制度，臺北市設第一、第二稅務稽徵所管轄本市稅捐稽徵業務，民國 36 年 1 月合併成立臺北市稅捐稽徵處，下設 6 課及城中、中山、延平、萬華、古亭、松山等分處，掌理國、省、地方稅捐稽徵事宜，在系統上隸屬於臺北市政府而受臺灣省政府財政廳指揮監督。

民國 56 年 7 月臺北市改制為直轄市，財政部同時成立臺北市國稅局（102 年更名為財政部臺北國稅局）負責國稅之徵收，本處負責直轄市稅捐稽徵，並同時增設建成分處。民國 57 年 7 月，將市郊景美、木柵、南港、內湖及陽明山管理局之士林、北投等 6 鄉鎮正式劃入為臺北市管轄，除士林、北投另成立為陽明山管理局稅捐稽徵處外，景美、木柵 2 區成立景美分處，南港、內湖 2 區成立南港分處，隸屬於本處。民國 60 年 7 月，因大安區發展迅速，為加強便民服務，由古亭分處撥出成立大安分處。民國 63 年 1 月，原陽明山管理局稅捐稽徵處改隸本處，改設為士林分處。民國 75 年 1 月建成分處併入延平分處，士林分處劃出成立北投分處。民國 77 年 6 月增設內湖及大同 2 個分處。

民國 80 年 7 月，配合臺北市行政區調整為 12 區，本處按行政區域及業務情況設置 13 個分處，分別為中正（城中、古亭合併）、中北、中南（中山分出）、北投、萬華、信義（松山分出）、大安、松山、南港、文山（景美更名）、士林、內湖、大同（延平併入）等分處，就近為市民提供最便捷的納稅服務。

民國 88 年營業稅改制為國稅，仍由本處代徵，10 月為落實組織精簡，提升組織效能，實施組織重整並彈性調整各分處內部架構，業務量較大之大安、中南、中北、松山 4 個分處改設 5 個股，業務量較小之北投、內湖、南港、文山 4 個分處改設 3 個股，其餘大同、中正、信義、萬華、士林等 5 分處仍設 4 個股，並將娛樂稅、印花稅稽徵業務改由分處辦理。

民國 92 年 1 月營業稅移撥由財政部臺北市國稅局稽徵。本處負責房屋稅、地價稅、土地增值稅、契稅、使用牌照稅、娛樂稅、印花稅等地方稅及工程受益費之稽徵。同時重新訂定組織架構，將總處調整為 5 科 5 室，分處仍維持不變，除大安分處設置 4 個股外，其餘分處設置 3 個股。為因應業務需要增設第 2 位副處長職位，於 94 年 1 月正式派任。

民國 95 年 1 月為擴增服務據點，使用牌照稅業務比照其他稅目，將稽徵作業之執行改由分處辦理，人員配合移撥分處。松山分處因牌照稅業務量及員額配置較多，專設 1 股辦理該項業務，改置為 4 個股，至民國 100 年 9 月為配合使用牌照稅稽徵業務回歸機會稅科管理，復調整為 3 個股。

臺北市稅捐稽徵處暨所屬各分處稽徵區域圖

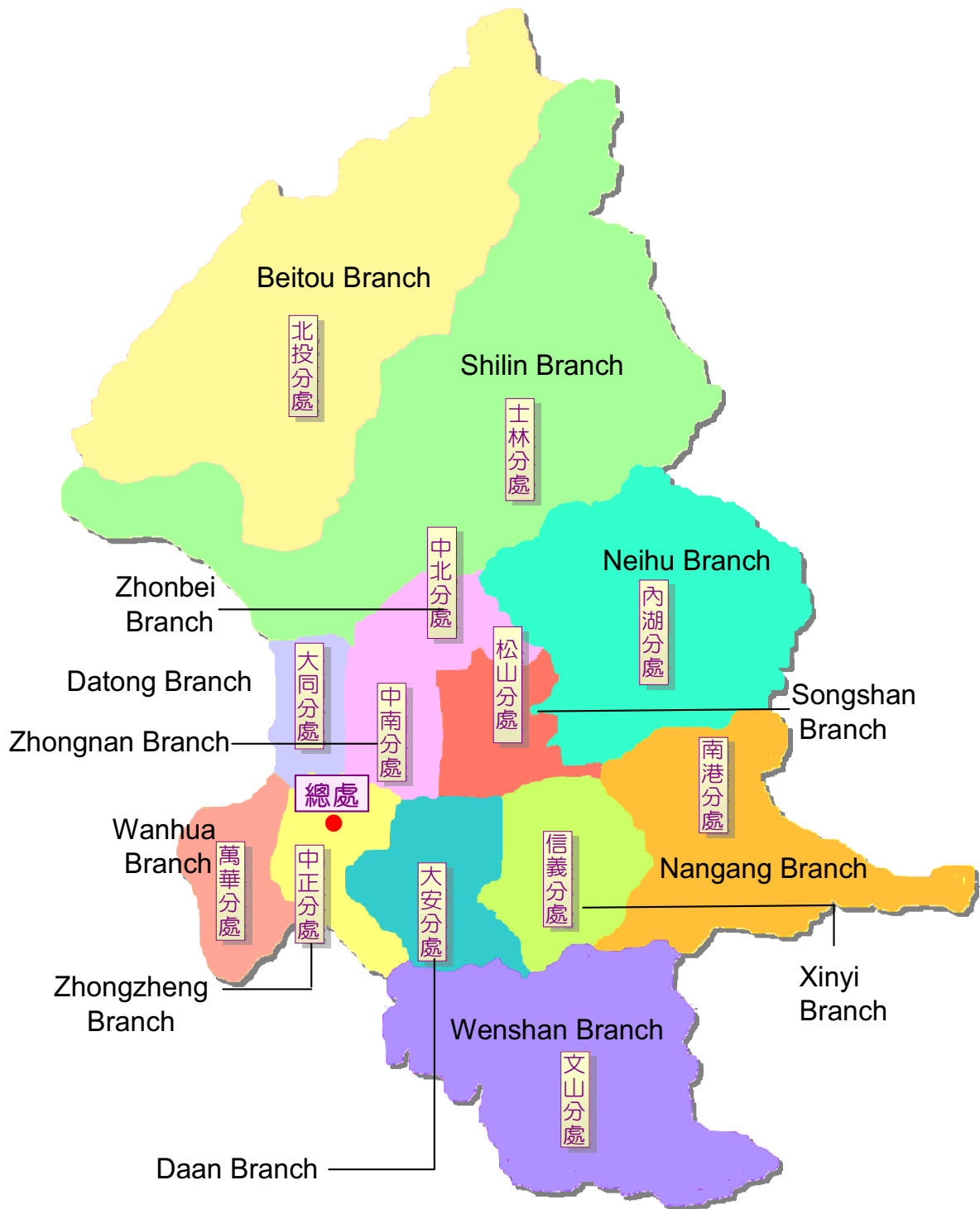

二、組織

本處組織：

依據臺北市政府 93 年 7 月 30 日府法三字第 09312725300 號令，「臺北市稅捐稽徵處組織規程」核定本處隸屬於臺北市政府財政局，置處長 1 人，綜理處務，並置副處長 2 人襄理處務，下設 5 科 5 室及 13 個分處掌理各項地方稅捐稽徵業務。

臺北市稅捐稽徵處組織圖

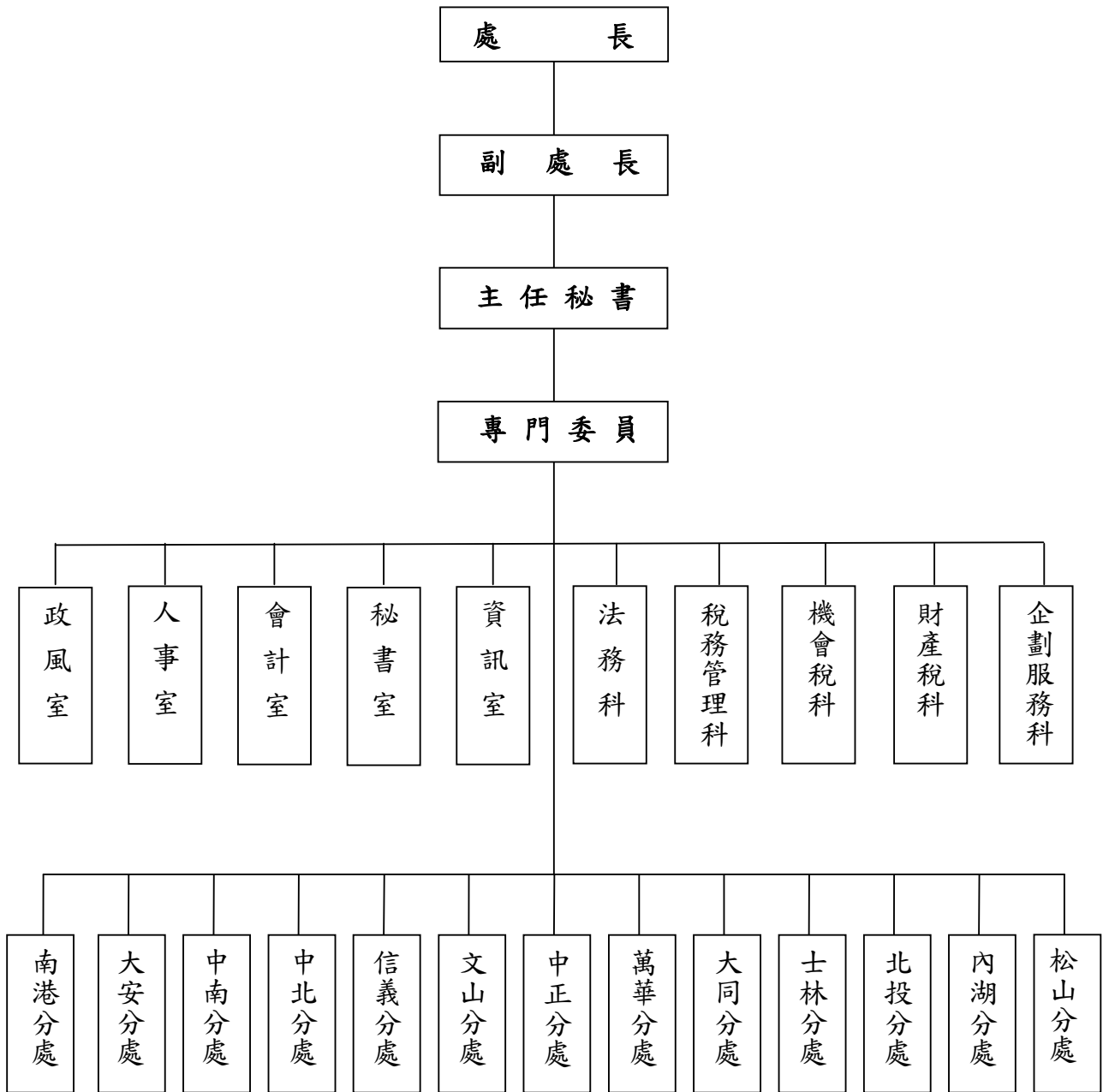

三、人事

本處奉准編制員額 846 人，民國 103 年 12 月底現有職員 750 人。現有人員按學歷別分析，研究所畢業者 72 人占 9.6%，大專畢業者 637 人占 85%，高中(職)畢業者 40 人占 5.3%，國中畢業者 1 人占 0.1%；按考試及格別來看，其中高等考試及格者 172 人占 22.9%，普通考試及格者 91 人占 12.1%，特種考試及格者 332 人占 44.3%，升等考試及格者 115 人占 15.4%，初等考試及格者 31 人占 4.1%，其他考試及格者 8 人占 1.1%，依其他法令進用者 1 人占 0.1%；按年齡別分，20 歲至 29 歲 88 人占 11.7%，30 歲至 39 歲 188 人占 25.1%，40 歲至 49 歲 219 人占 29.2%，50 歲至 59 歲 218 人占 29.1%，60 歲以上 37 人占 4.9%，平均年齡為 43.54 歲。



表 19 本處人事概況
 (一)法定員額與現有員額
 103年12月底

單位：人

職 稱	Position	法定員額 Budget Staff		現有員額 Actual Staff	備 註	
		職 等	員 額			
總 計	Total		846	750	本表法定員額係奉 臺北市政府 93 年 7 月 30 日府法三字第 09312725300 號令核 定之員額。	
處 長	Director	第 十 一 職 等	1	1		
副 處 長	Deputy Director	第 十 職 等	2	2		
主 任 秘 書	Chief Secretary	第 九 職 等	1	1		
專 門 委 員	Senior Specialist	第 九 職 等	2	1		
科 長	Section Chief	第 八 職 等	5	5		
分 處 主 任	Manager, Branch	第 八 至 九 職 等	13	13		
主 任	Chief	第 八 職 等	2	2		
秘 書	Secretary	第 七 至 八 職 等	3	3		
督 導	Inspector	第 七 至 八 職 等	3	1		
審 核 員	Revenue Assessor	第 七 至 八 職 等	19	19		
專 員	Specialist	第 七 至 八 職 等	1	1		
股 長	Sub-section Chief	第 七 職 等	62	61		
分 析 師	Systems Analyst	第 七 職 等	2	2		
設 計 師	Systems Designer	第 五 或 六 至 七 職 等	14	13		
管 理 師	Systems Coordinator	第 五 或 六 至 七 職 等	4	4		
助 理 設 計 師	Assistant Systems Designer	第 三 至 五 職 等	6	4		
助 理 管 理 師	Assistant Systems Coordinator	第 三 至 五 職 等	1	1		
稅 務 員	Revenue Officer	第 五 或 六 至 七 職 等	344	328		
助 理 稅 務 員	Revenue Assistant	第 三 至 五 職 等	167	151		
科 員	Section Assistant	第 五 或 六 至 七 職 等	6	5		
辦 事 員	Senior Clerk	第 三 至 五 職 等	19	20		
書 記	Clerk	第 一 至 三 職 等	124	72		(內 3 人俟雇員出 缺後改置)

續下頁

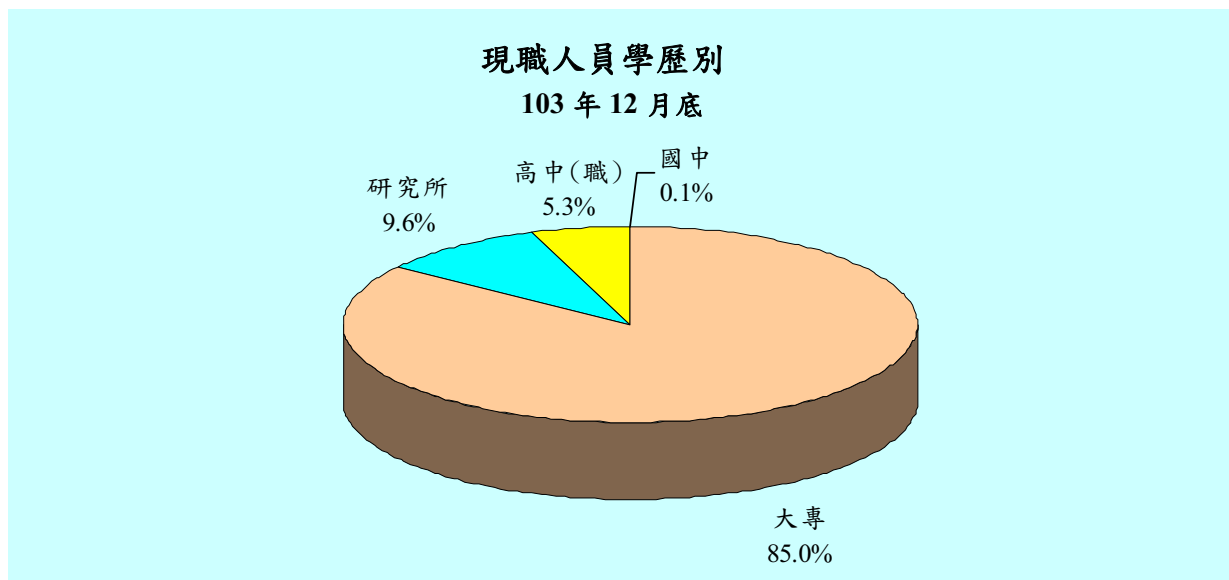
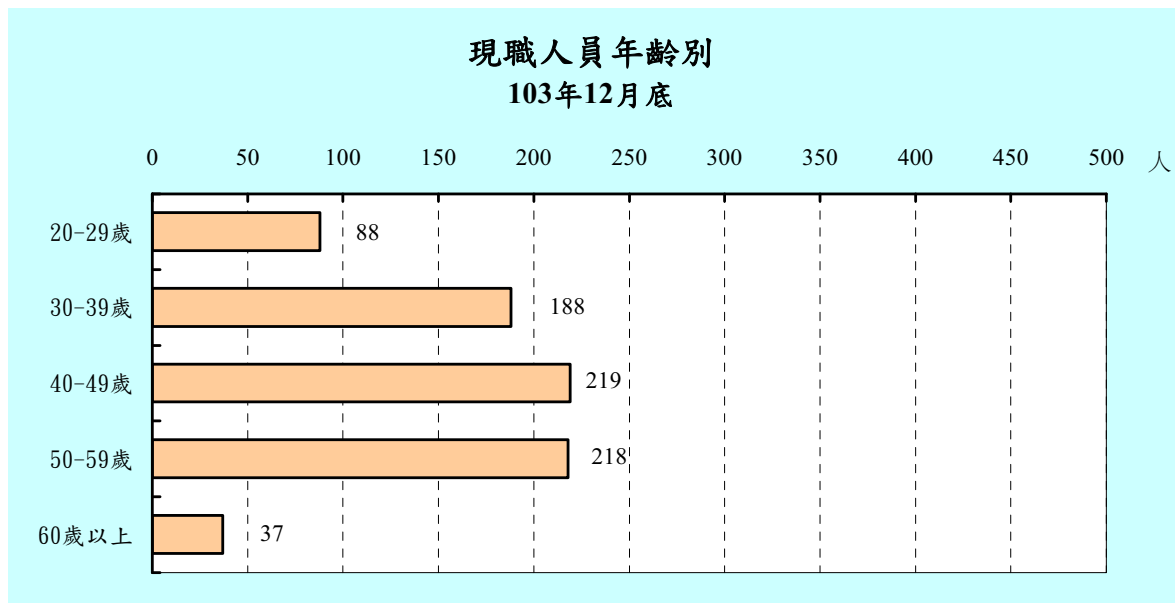
表 19 本處人事概況(續 1)

(一)法定員額與現有員額

103 年 12 月底

單位：人

職 稱 Position	法定員額 Budget Staff		現有員額 Actual Staff	備 註	
	職 等	員 額			
會計室 Accounting office	會計主任 Chief Accounting Officer	第 八 職 等	1	1	
	專員 Specialist	第 七 至 八 職 等	1	1	
	股長 Sub- section Chief	第 七 職 等	4	4	
	科員 Section Assistant	第 五 或 六 至 七 職 等	11	11	
	辦事員 Senior Clerk	第 三 至 五 職 等	1	1	
	書記 Clerk	第 一 至 三 職 等	2	—	
	人 事 室 Personnel Office	主任 Chief Personnel Officer	第 八 職 等	1	1
專員 Specialist		第 七 至 八 職 等	1	1	
股長 Sub- section Chief		第 七 職 等	3	2	
科員 Section Assistant		第 五 或 六 至 七 職 等	8	7	
助理員 Assistant		第 四 至 五 職 等	2	1	(內 1 人得列 薦任)
書記 Clerk		第 一 至 三 職 等	1	1	
政 風 室 Government Ethics Office		主任 Chief Government Ethics Officer	第 八 職 等	1	1
	股長 Sub- section Chief	第 七 職 等	2	2	
	科員 Section Assistant	第 五 或 六 至 七 職 等	4	4	
	辦事員 Senior Clerk	第 三 至 五 職 等	1	1	
	書記 Clerk	第 一 至 三 職 等	1	1	

附註：根據本處人事室資料編製。

表 19 本處人事概況(續 2)

(二) 年齡與職等、性別

103 年 12 月底

單位：人

年 齡 age	官 等 Official Classes					性 別 Sex		
	共 計 Total	10-14 職等 Selected Appointment	6-9 職等 Recommended Appointment	1-5 職等 Delegated Appointment	雇 員 Assistant Clerk	共 計 Total	男 Male	女 Female
總 計 Grand Total	750	3	395	349	3	750	147	603
20 歲 - 29 歲	88	—	35	53	—	88	11	77
30 歲 - 39 歲	188	—	98	90	—	188	50	138
40 歲 - 49 歲	219	—	118	101	—	219	32	187
50 歲 - 59 歲	218	1	126	89	2	218	44	174
60 歲 以 上	37	2	18	16	1	37	10	27

(三) 學歷及考試

103 年 12 月底

單位：人

學 歷 及 考 試 別 Educational & Examination	共 計 Total	10-14 職等 Selected Appointment	6-9 職等 Recommended Appointment	1-5 職等 Delegated Appointment	雇 員 Assistant Clerk
(1) 學 歷 Education	750	3	395	349	3
研 究 所 Graduate School	72	—	61	11	—
大 專 Junior College	637	3	329	303	2
高 中 (職) Senior High School	40	—	5	34	1
國 (初) 中 及 以 下 Junior High School and Under	1	—	—	1	—
(2) 考 試 Examination	750	3	395	349	3
高 等 考 試 Senior Civil Service Exam.	172	1	157	14	—
普 通 考 試 Junior Civil Service Exam.	91	—	35	56	—
特 種 考 試 Special Civil Service Exam.	332	1	139	192	—
升 等 考 試 Rank Promotion Service Exam.	115	—	62	53	—
初 等 考 試 Elementary Civil Service Exam.	31	—	—	31	—
其 他 考 試 Other Civil Service Exam.	8	1	2	2	3
依 其 他 法 令 進 用 By Other Means	1	—	—	1	—

表 19 本處人事概況(續 3 完)

(四)年 資

103 年 12 月底

單位：人

年 資 Seniority	共 計 Total	10—14 職等 Selected Appointment	6—9 職等 Recommended Appointment	1—5 職等 Delegated Appointment	雇 員 Assistant Clerk
總 計 Grand Total	750	3	395	349	3
5 年 以 下	334	—	155	179	—
6 年— 9 年	70	—	25	45	—
10 年—14 年	77	—	41	36	—
15 年—19 年	137	—	76	59	2
20 年—24 年	64	—	42	22	—
25 年—29 年	37	—	31	6	—
30 年 以 上	31	3	25	2	1

(五)工 作 類 別

103 年 12 月底

單位：人

工 作 類 別 Job	共 計 Total	10—14 職等 Selected Appointment	6—9 職等 Recommended Appointment	1—5 職等 Delegated Appointment	雇 員 Assistant Clerk
總 計 Grand Total	750	3	395	349	3
行 政	68	—	10	58	—
財 政	610	3	341	266	—
人 事	13	—	9	4	—
會 計	18	—	14	4	—
雇 員	3	—	—	—	3
資 訊 處 理	29	—	15	14	—
政 風	9	—	6	3	—
安 全 保 防	—	—	—	—	—

表 20 本處歲出預決算數

單位：新臺幣元

年度及科目別	預 算		決 算		決算數 占預算數 之比率 % (2/1)×100
	金 額 (1)	%	金 額 (2)	%	
94 年 度	922,830,712	100.0	908,367,765	100.0	98.4
95 年 度	929,515,635	100.0	918,257,368	100.0	98.8
96 年 度	917,289,764	100.0	895,615,954	100.0	97.6
97 年 度	923,887,755	100.0	895,044,198	100.0	96.9
98 年 度	925,665,198	100.0	898,324,537	100.0	97.0
99 年 度	910,138,102	100.0	898,108,142	100.0	98.7
100 年 度	924,158,185	100.0	915,283,662	100.0	99.0
101 年 度	926,239,026	100.0	898,931,066	100.0	97.1
102 年 度	937,691,092	100.0	916,073,419	100.0	97.7
103 年 度	928,468,874	100.0	918,028,505	100.0	98.9
一般行政	171,388,482	18.5	169,289,734	18.4	98.8
行政管理	171,388,482	18.5	169,289,734	18.4	98.8
稅捐稽徵業務	747,670,034	80.5	740,637,714	80.7	99.1
財產稅稽徵	362,987,838	39.1	362,373,673	39.5	99.8
機會稅稽徵	65,991,329	7.1	64,711,856	7.0	98.1
稅務管理	215,625,797	23.2	213,500,004	23.3	99.0
違章及行政救濟	16,078,112	1.7	15,723,315	1.7	97.8
電子處理資料	86,986,958	9.4	84,328,866	9.2	96.9
建築及設備	9,410,358	1.0	8,101,057	0.9	86.1
土地購置	100,000	0.0	10,500	0.0	10.5
營建工程	5,332,956	0.6	4,926,821	0.5	92.4
交通及運輸設備	545,000	0.1	539,743	0.1	99.0
其他設備	3,432,402	0.4	2,623,993	0.3	76.4

資料來源：依據審計部臺北市審計處審核決算審定書編製。

附 註：1. 本表未包括統籌科目。

2. 103年度決算數尚未經審計部臺北市審計處審定。

中華民國 103 年度
臺北市稅捐統計年報

出版機關：臺北市稅捐稽徵處

發行人：黃素津

編輯：臺北市稅捐稽徵處會計室

地址：臺北市中正區北平東路 7 之 2 號

電話：(02)23949211 分機 341

網址：www.tpctax.gov.taipei

創刊日期：中華民國 42 年 2 月

出版日期：中華民國 104 年 3 月

出刊頻率：年刊

本刊登載於本處網站



依法納稅是義務
合法節稅是權利
主動退稅是責任