

中華民國104年度  
**臺北市稅捐統計年報**

YEARBOOK OF MUNICIPAL TAX  
STATISTICS OF TAIPEI CITY  
2015



**臺北市稅捐稽徵處**  
TAIPEI CITY **R**EVENUE **S**ERVICE  
105年3月編製

## 編 製 說 明

- 一、本刊之編製，旨在提供本處稽徵業務執行與成果資料，以為公務計畫、執行、考核及財務管理上之參考。
- 二、本刊資料內容包括稅收概況、稅收統計、稅源及其他、行政組織等 4 大項。
- 三、本刊所稱「年度」係指政府會計年度，採曆年制(當年 1 月 1 日至同年 12 月 31 日)。
- 四、本刊數字因尾數四捨五入，故部分總數與細項之間，或有未能吻合情事，計算時仍以原始數據計算。
- 五、本刊所有符號「—」表示無數值，「--」表示無意義數值，「...」表示數值不明或尚未產生資料，「0」表示有數值而不及半單位，數字前加(-)者表示退稅或減免數，(+)者表示增加數，「Ⓘ」表示修正數。
- 六、本刊以前各期數字，若與本期有出入者，以本期所列數字為準。

# 目 次

## 壹、稅收概況

一、104 年度稅收概況 .....	2
二、近 10 年稅收 .....	3
三、地價稅 .....	4
四、土地增值稅 .....	5
五、房屋稅 .....	6
六、使用牌照稅 .....	7
七、契稅 .....	8
八、印花稅 .....	9
九、娛樂稅 .....	10

## 貳、稅收統計

表 1 各項稅捐徵績比較 .....	12
表 2 歷年各項稅捐預算數、查定數與實徵數	
(一)總計 .....	14
(二)稅課收入	
1. 合計 .....	16
2. 地價稅 .....	18
3. 土地增值稅 .....	20
4. 房屋稅 .....	22
5. 使用牌照稅 .....	24
6. 契稅 .....	26
7. 印花稅 .....	28
8. 娛樂稅 .....	30

# CONTENTS

## I. Analysis of Revenues from Taxes

A. Tax Revenues in 2015 .....	2
B. Tax Revenues in Nearly 10 Years .....	3
C. Land Value Tax .....	4
D. Land Value Increment Tax .....	5
E. House Tax .....	6
F. Vehicle License Tax .....	7
G. Deed Tax .....	8
H. Stamp Tax .....	9
I. Amusement Tax .....	10

## II. Tax Revenue Statistics

Table 1. Net Tax Revenues Compare .....	12
Table 2. Budget Amount, Audited Amount and Actual Collection in Recent Years	
( I ) Grand Total .....	14
( II ) Revenues from Taxes	
1. Total .....	16
2. Land Value Tax .....	18
3. Land Value Increment Tax .....	20
4. House Tax .....	22
5. Vehicle License Tax .....	24
6. Deed Tax .....	26
7. Stamp Tax .....	28
8. Amusement Tax .....	30

## 9. 九年國民義務教育附徵教育經費

(1)小計	32
(2)房屋稅	34
(3)娛樂稅	36
(三)工程受益費	38
(四)罰鍰收入	40
(五)規費收入	42
表 3 各項稅捐納庫數	
(一)歷年別	44
(二)稅目別	46
表 4 歷年各項稅捐實徵淨額及指數	48
表 5 本處各項稅捐稽徵成本	52

## 參、稅源及其他

表 6 地價稅稅源	54
表 7 土地增值稅稅源	56
表 8 房屋稅稅源	58
表 9 使用牌照稅稅源	62
表 10 契稅稅源	64
表 11 印花稅稅源	66
表 12 娛樂稅稅源	68
表 13 違章漏稅案件處理及財務罰鍰執行情形	72
表 14 各項稅捐滯納案件移送執行情形	76
表 15 查(核)定開徵數及未徵數情形	78

9. Education Surtax	
( 1 ) Subtotal	32
( 2 ) House Tax	34
( 3 ) Amusement Tax	36
(III) Construction Benefit Fee	38
(IV) Punitive Fine Revenue	40
(V) Fees Revenue	42
Table 3. Taxation Forwarded to Treasury	
( I ) Fiscal Year	44
( II ) Item of Tax	46
Table 4. Net Amount Remitted and Index in Recent Years	48
Table 5. Cost of Tax Levying	52

### **III. Tax Sources and Others**

Table 6. Sources of Land Value Tax	54
Table 7. Sources of Land Value Increment Tax	56
Table 8. Sources of House Tax	58
Table 9. Sources of Vehicle License Tax	62
Table 10. Sources of Deed Tax	64
Table 11. Sources of Stamp Tax	66
Table 12. Sources of Amusement Tax	68
Table 13. The Management of Cases of Tax Evasion Against Law and Execution Status of Fine	72
Table 14. The Status of Delayed Case Transferred to Execution	76
Table 15. The Management of Opening Collection for Assessed(Verified) and of Tax Not Collected	78

表 16 各項稅捐現行稅率表	86
表 17 各項稅捐劃解分配率	93
表 18 本處各項稅捐稽徵工作流程圖	
(一)地價稅	94
(二)土地增值稅	95
(三)房屋稅	96
(四)使用牌照稅	97
(五)契稅	98
(六)印花稅	99
(七)娛樂稅	100
(八)支票退稅	101

## 肆、行政組織

一、沿革 (附圖)	105
二、組織 (附圖)	107
三、人事 (附圖)	109
表 19 本處人事概況	
(一)法定員額與現有員額	110
(二)年齡與職等、性別	112
(三)學歷及考試	112
(四)年資	113
(五)工作類別	113
表 20 本處歲出預決算數	114

Table 16. Current Tax Rates for Taxation .....	86
Table 17. The Distribution Rates of Tax .....	93
Table 18. Work Flow Chart	
( I ) Land Value Tax .....	94
( II ) Land Value Increment Tax .....	95
( III ) House Tax .....	96
( IV ) Vehicle License Tax .....	97
( V ) Deed Tax .....	98
( VI ) Stamp Tax .....	99
( VII ) Amusement Tax .....	100
( VIII ) Check Refund .....	101

#### **IV. Administrative Organization**

A. The History .....	105
B. Organization .....	107
C. Personnel .....	109
Table 19. Personnel Statistic	
( I ) Personnel Management & Present Personnel .....	110
( II ) By Age & Official Class & Sex .....	112
( III ) By Educational Attainment & Recruitment Way .....	112
( IV ) By Length of Service .....	113
( V ) Work Type .....	113
Table 20. Budget and Closed Account of Expenditures .....	114



# 壹、稅收概況

## I . Analysis of Revenues from Taxes

## 一、104 年度稅收概況

104 年度本市地方稅稅收實徵淨額 768.23 億元，較預算數 650.75 億元，超徵 117.48 億元，年度預算達成率 118.1%，各項稅收與預算數比較，其中以土地增值稅超徵最多，主要係因 104 年度調漲土地公告現值及 105 年 1 月 1 日起實施房地合一課徵所得稅制度影響，有多筆大面積土地移轉，致實徵淨額達 257.68 億元，超徵 81.68 億元；其次，房屋稅因 103 年 7 月 1 日起調高新建房屋之房屋構造標準單價，及調升非自住之住家用房屋稅率，實徵淨額達 141.95 億元，超徵 15.95 億元；此外，契稅、使用牌照稅、印花稅、地價稅及娛樂稅亦均為超徵，其超徵金額分別為 8.13 億元、6 億元、2.69 億元、2.4 億元及 0.63 億元。

### 104 年度地方稅稅課收入

單位：新臺幣億元

項目	預算數 (1)	實徵淨額 (2)	超(短)徵		預算達成率 (5)=(2)/(1)*100
			金額 (3)=(2)-(1)	百分比 (4)=(3)/(1)	
稅課收入	650.75	768.23	117.48	18.1%	118.1%
地價稅	218.00	220.40	2.40	1.1%	101.1%
土地增值稅	176.00	257.68	81.68	46.4%	146.4%
房屋稅	126.00	141.95	15.95	12.7%	112.7%
使用牌照稅	68.00	74.00	6.00	8.8%	108.8%
契稅	18.00	26.13	8.13	45.2%	145.2%
印花稅	42.60	45.29	2.69	6.3%	106.3%
娛樂稅	2.15	2.78	0.63	29.3%	129.3%
教育經費	—	-0.00	--	--	--

### 104 年度各稅比重

實徵淨額總計 768.23 億元

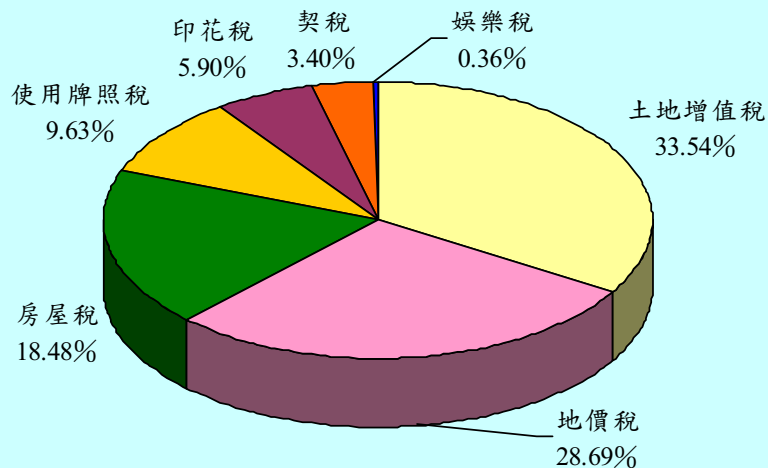

## 二、近 10 年稅收

### 近 10 年稅課收入

單位：新臺幣億元

年度別	預算數	實徵淨額	超(短)徵		實徵淨額與上年度增減比較	
			金額	百分比	金額	百分比
95	518.28	593.34	75.06	14.5%	--	--
96	530.93	616.96	86.03	16.2%	23.62	4.0%
97	540.34	565.71	25.37	4.7%	-51.25	-8.3%
98	535.20	573.45	38.25	7.1%	7.74	1.4%
99	527.10	608.45	81.35	15.4%	35.00	6.1%
100	562.68	619.99	57.31	10.2%	11.54	1.9%
101	610.50	621.89	11.39	1.9%	1.90	0.3%
102	604.30	663.11	58.81	9.7%	41.22	6.6%
103	630.75	672.91	42.16	6.7%	9.80	1.5%
104	650.75	768.23	117.48	18.1%	95.32	14.2%

### 近 10 年稅課收入預算數與實徵淨額

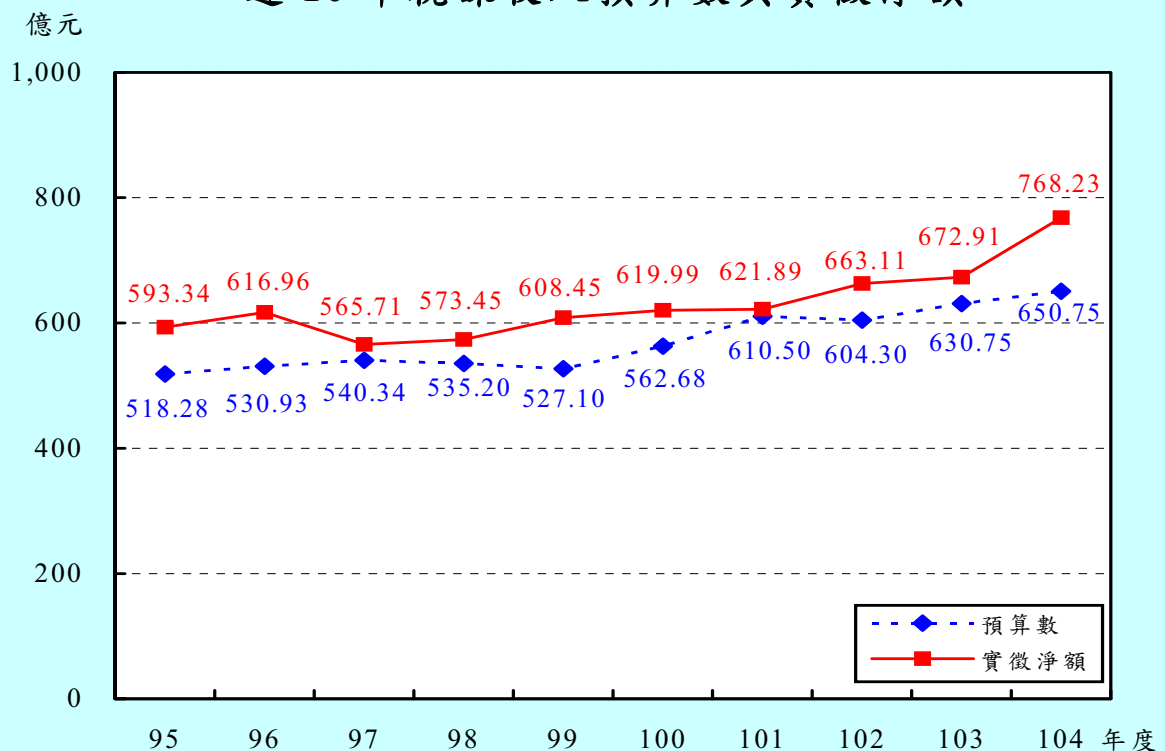

### 三、地價稅

104 年度實徵淨額 220.4 億元，與預算數 218 億元比較，增加 2.4 億元，超徵 1.1%；較上年度實徵淨額 224.48 億元減少 4.08 億元，負成長 1.8%。

104 年度因執行地價稅清查作業成果顯著及地價稅開徵起率較以前年度為高，致稅收超徵；惟因土地開發後產權細分，自用住宅用地戶增加，一般土地戶適用累進稅率級距降低，致稅收較上年度略為減少。

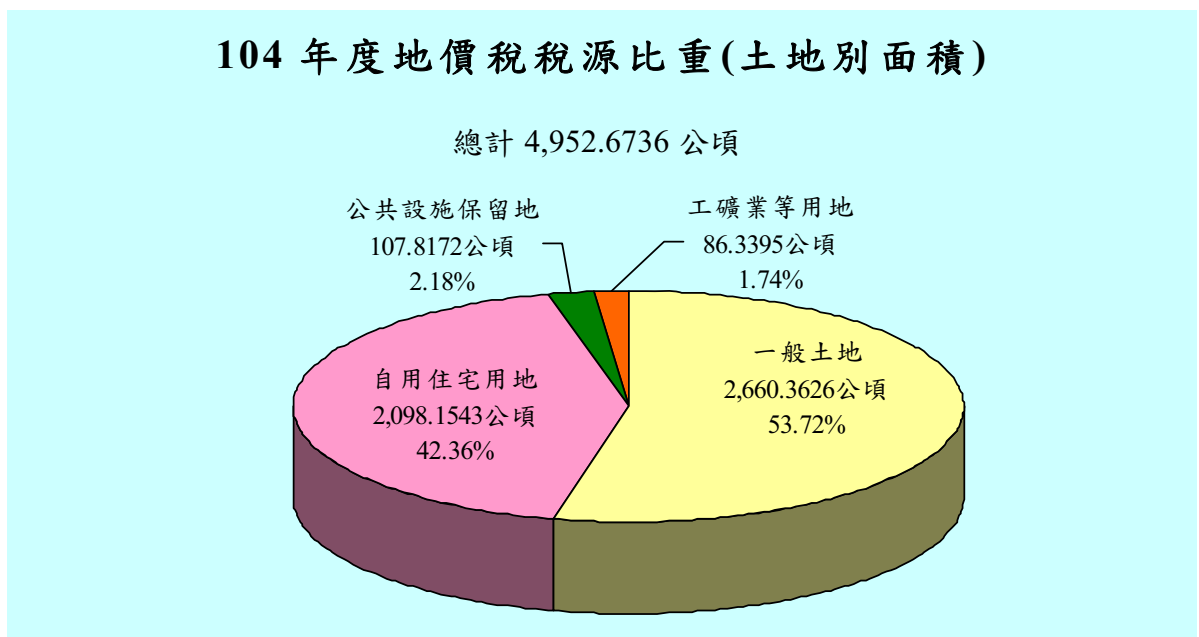
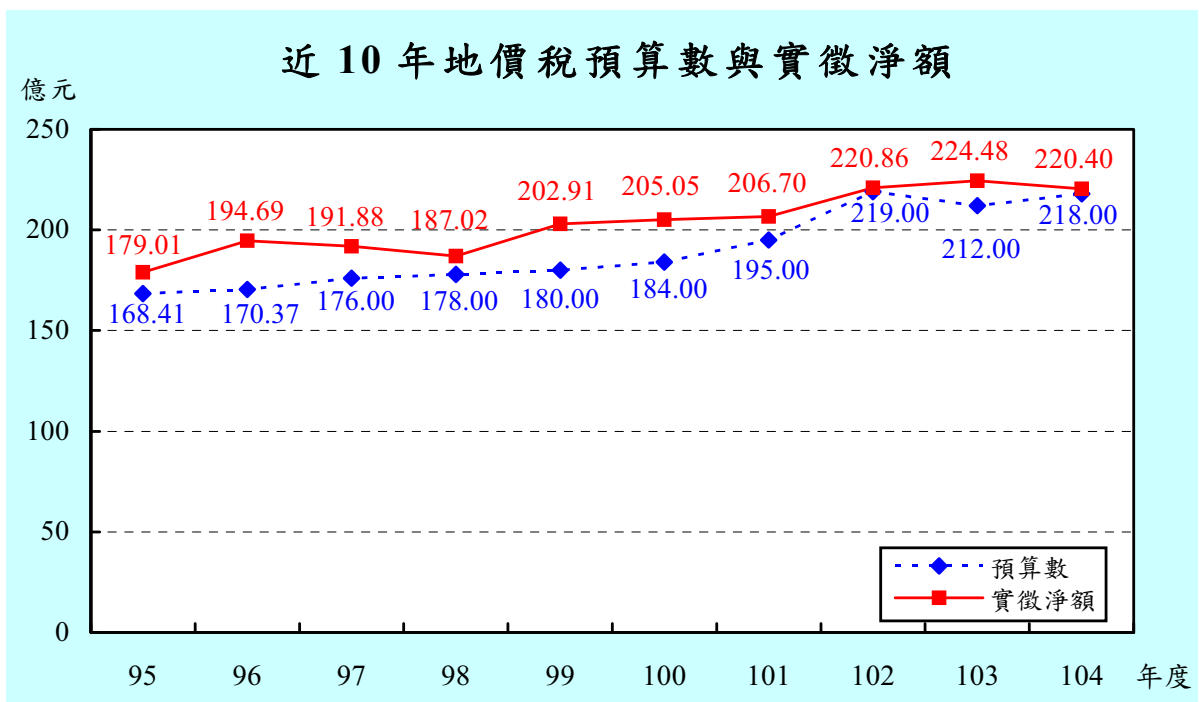

## 四、土地增值稅

104 年度實徵淨額 257.68 億元，與預算數 176 億元比較，增加 81.68 億元，超徵 46.4%；較上年度實徵淨額 190.67 億元增加 67.01 億元，成長 35.1%。

104 年度因公告土地現值平均調漲 10.63%，且受 105 年 1 月 1 日起實施房地合一課徵所得稅制度影響及有多筆大面積土地移轉，致稅收超徵且較上年度增加。

### 近 10 年土地增值稅預算數與實徵淨額

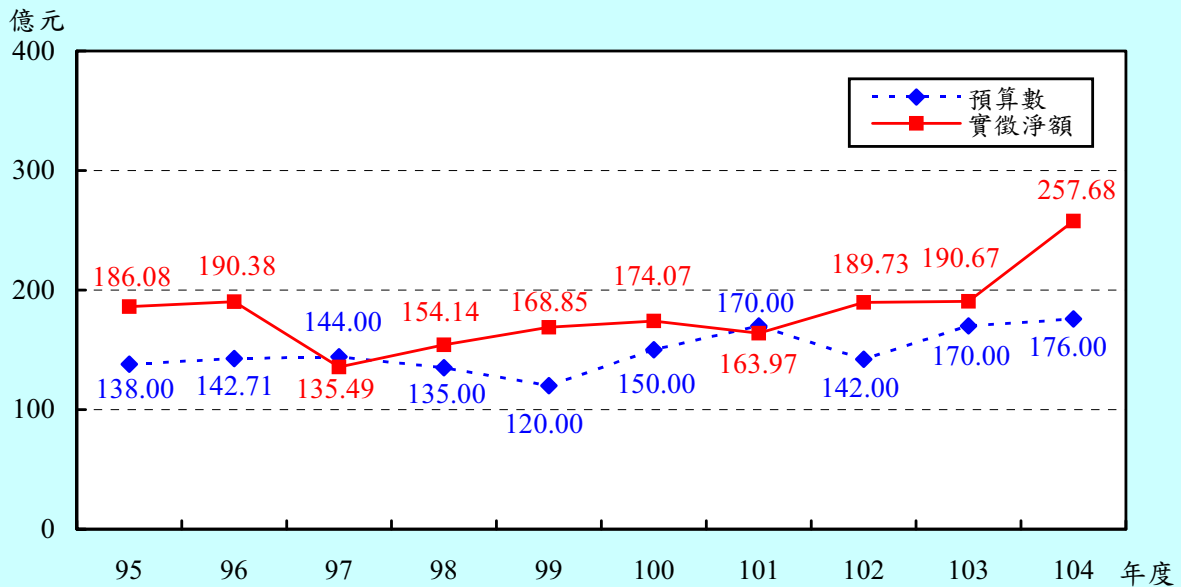

### 近 10 年移轉土地增值情形

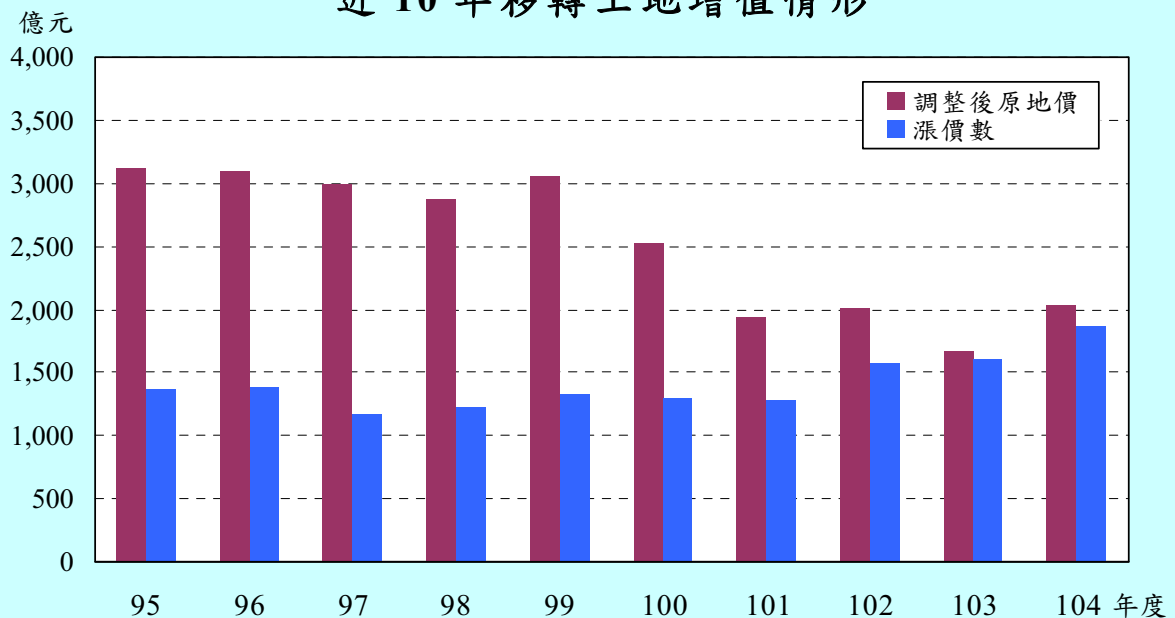

## 五、房屋稅

104 年度實徵淨額 141.95 億元，與預算數 126 億元比較，增加 15.95 億元，超徵 12.7%；較上年度實徵淨額 122.17 億元增加 19.78 億元，成長 16.2%。

104 年度因延續實施高級住宅加價課徵房屋稅政策，並自 103 年 7 月 1 日起，修正高級住宅認定標準由逐「棟」認定改採按「戶」認列、調高新建房屋構造標準單價、調整部分路段率，及提高非自住之其他供住家用、供私人醫院、診所、自由職業事務所使用之房屋稅率，又加強房屋稅稅籍及使用情形清查、積極清理欠稅、提高繳款書送達率，致稅收超徵且較上年度增加。

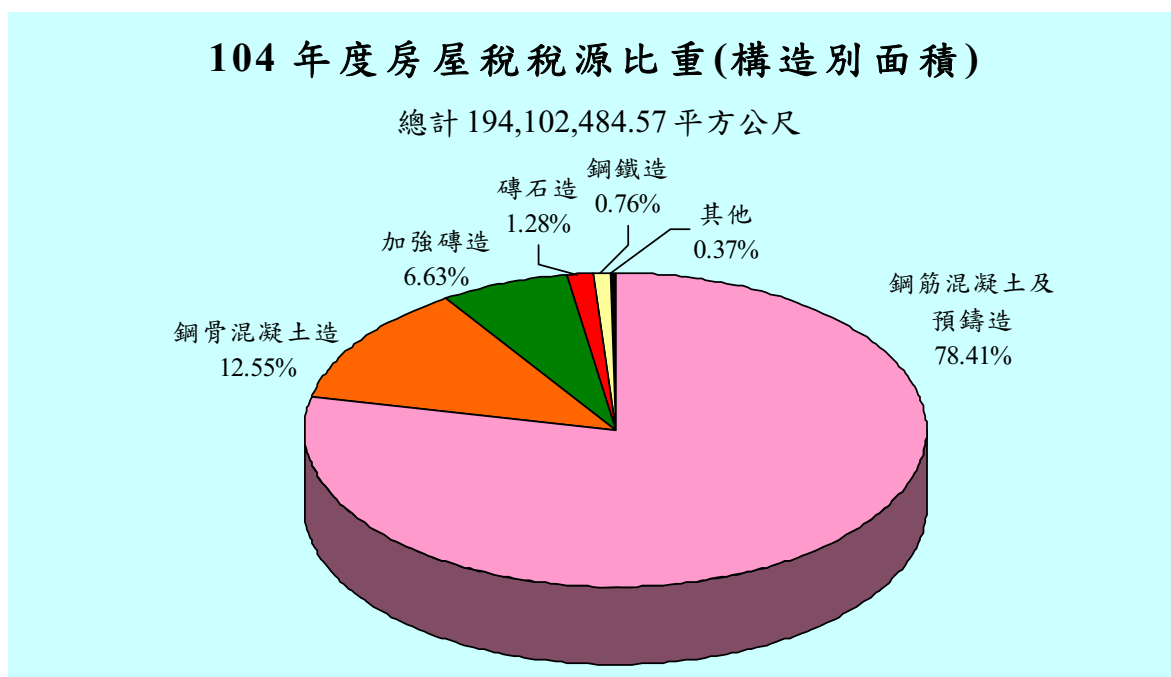
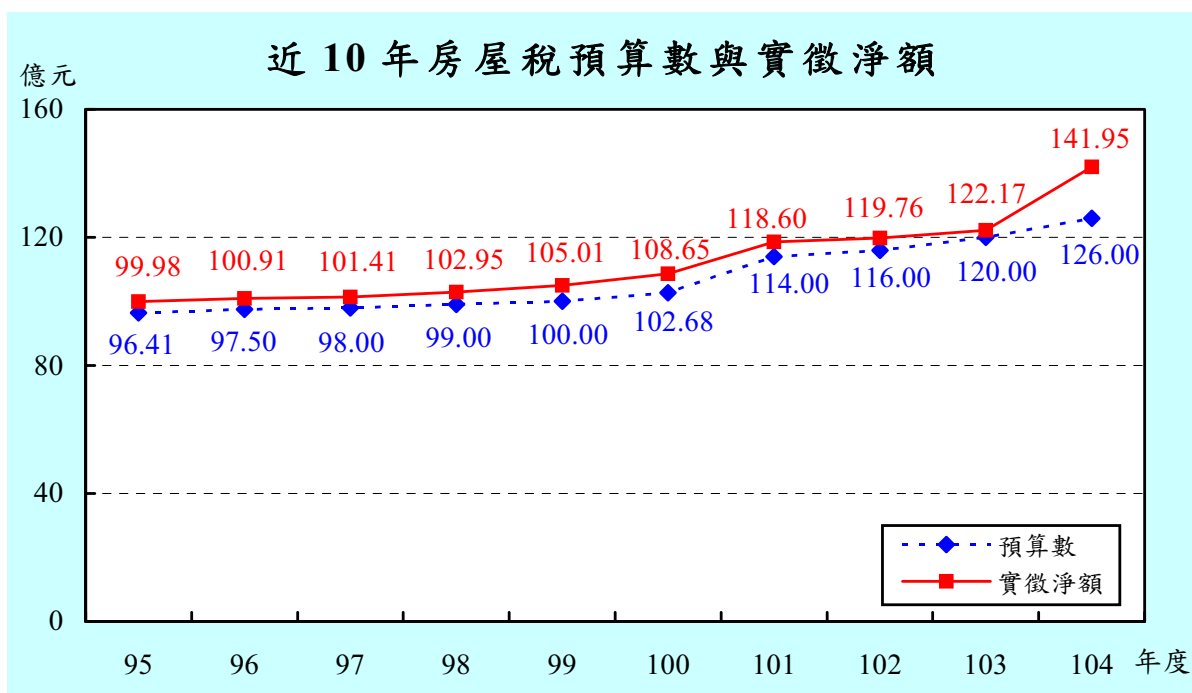

## 六、使用牌照稅

104 年度實徵淨額 74 億元，與預算數 68 億元比較，增加 6 億元，超徵 8.8%；較上年度實徵淨額 71.14 億元增加 2.86 億元，成長 4%。

104 年度因車輛數增加、積極辦理免稅案件清查及欠稅清理，另使用牌照稅法第 7 條第 1 項第 8 款身心障礙者免稅規定，自 104 年起增加親等限制及免稅限額之規範，致稅收超徵且較上年度增加。

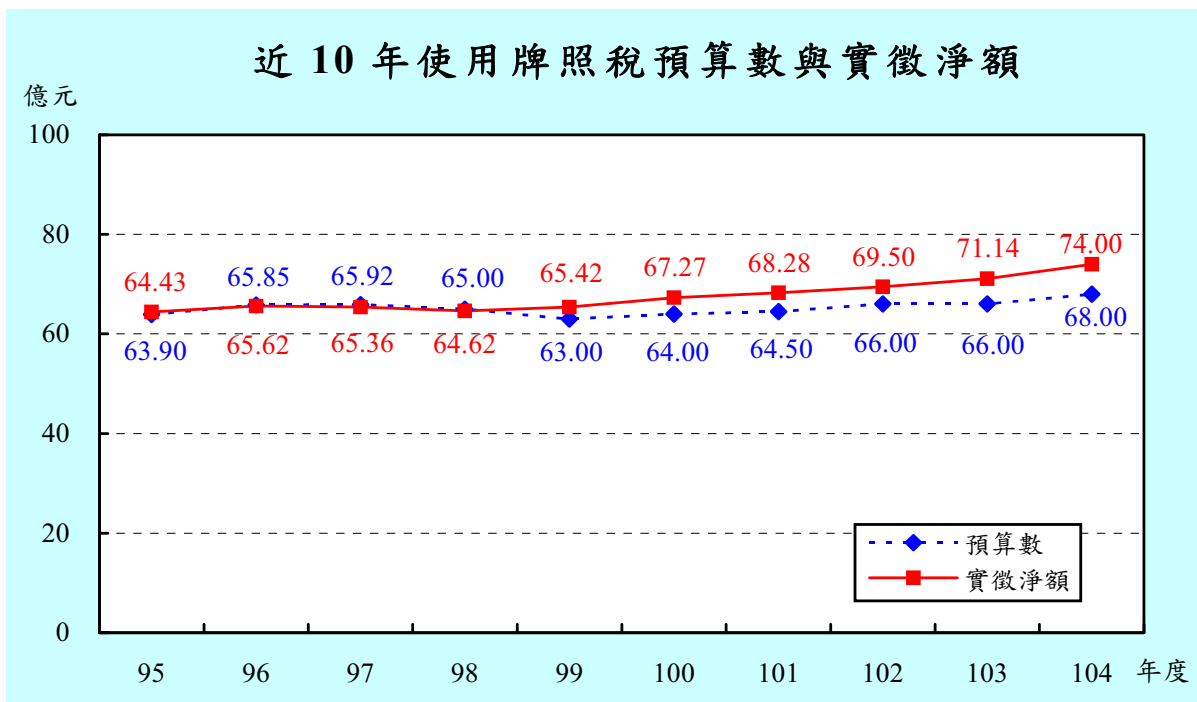

### 104 年度使用牌照稅稅源比重(車輛別件數)

總計 917,529 件

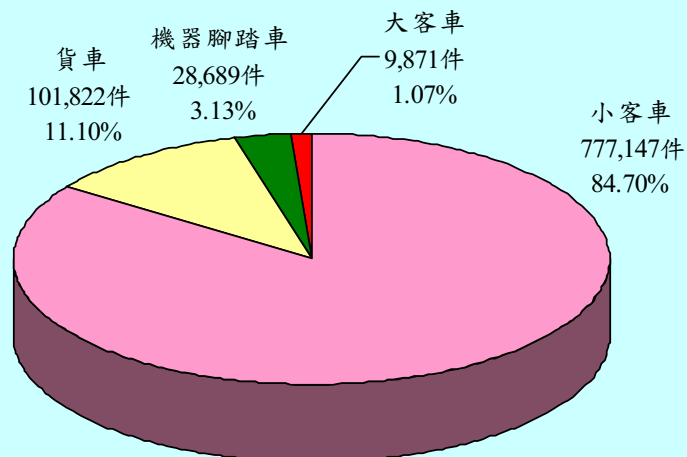

## 七、契稅

104 年度實徵淨額 26.13 億元，與預算數 18 億元比較，增加 8.13 億元，超徵 45.2%；較上年度實徵淨額 16.51 億元增加 9.62 億元，成長 58.3%。

104 年度因移轉房屋大多屬新建房屋，適用調高後新建房屋構造標準單價，其房屋現值較高，故契價較高，致稅收超徵且較上年度增加。

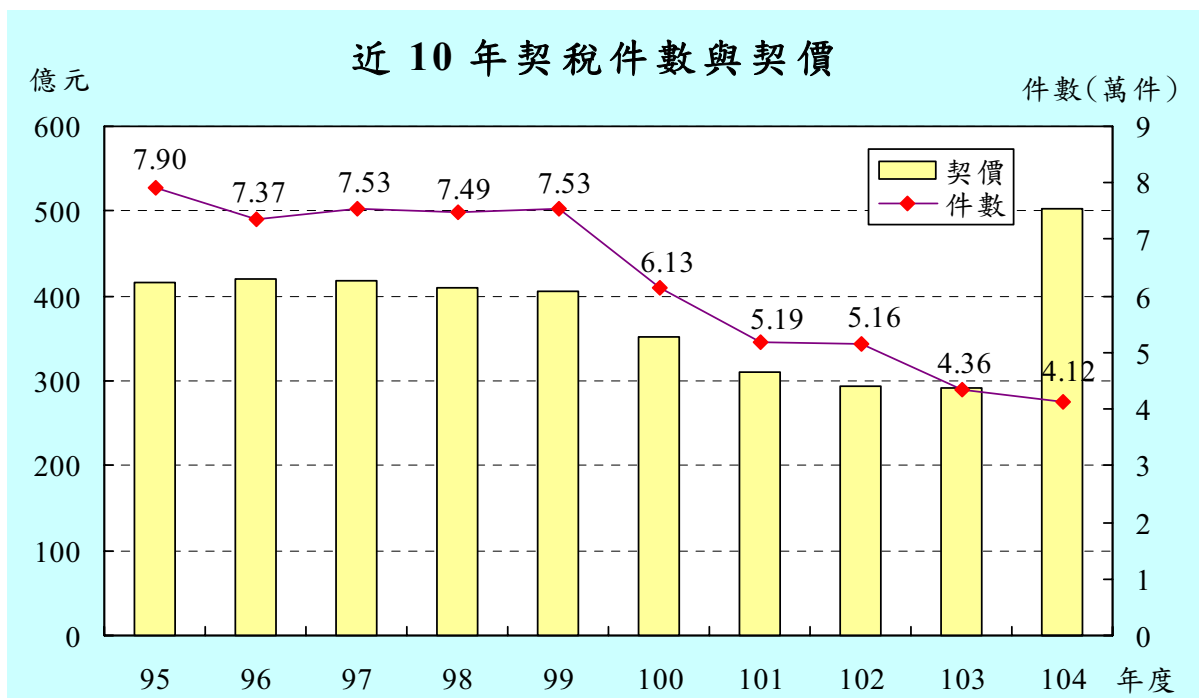
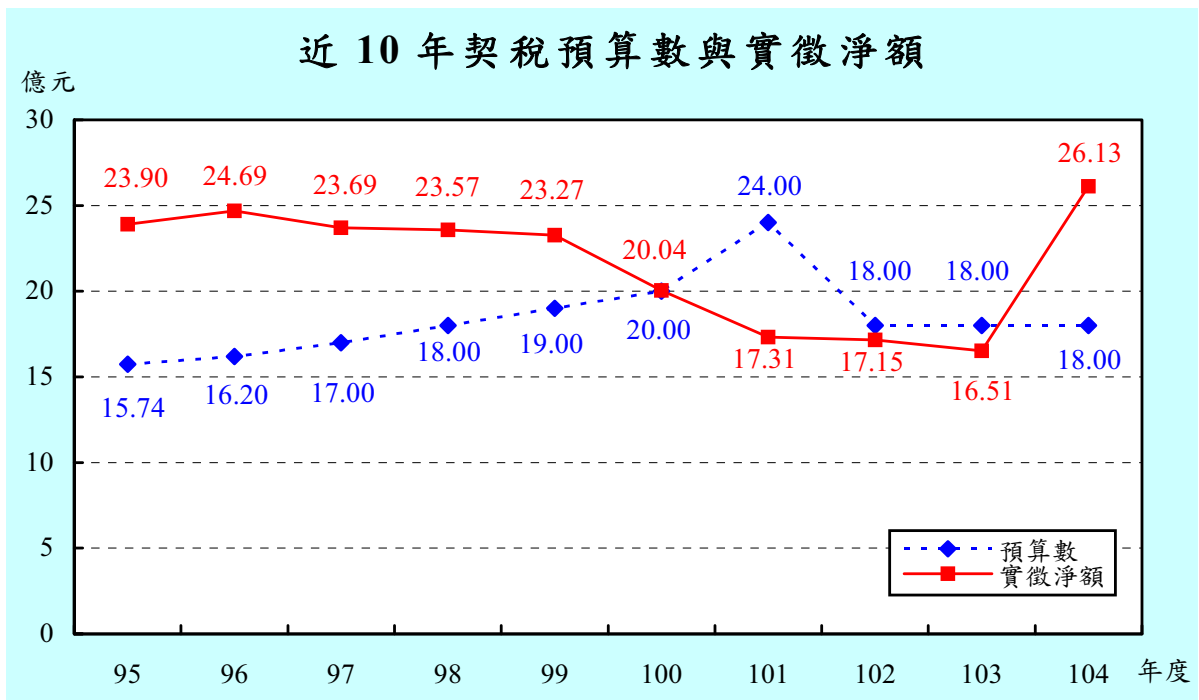

## 八、印花稅

104 年度實徵淨額 45.29 億元，與預算數 42.6 億元比較，增加 2.69 億元，超徵 6.3%；較上年度實徵淨額 45.59 億元減少 0.3 億元，負成長 0.7%。

104 年度因執行印花稅應稅憑證檢查作業及積極輔導納稅義務人依法繳納印花稅，致稅收超徵，惟因不動產交易量縮，致稅收較上年度略為減少。

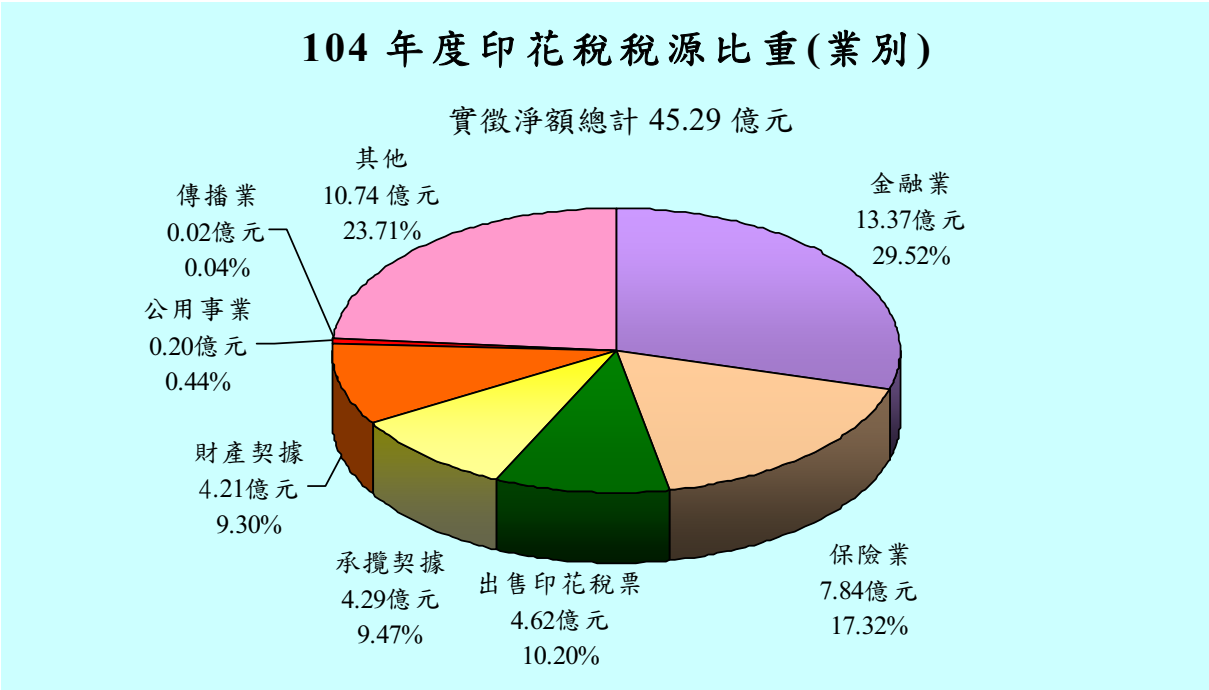
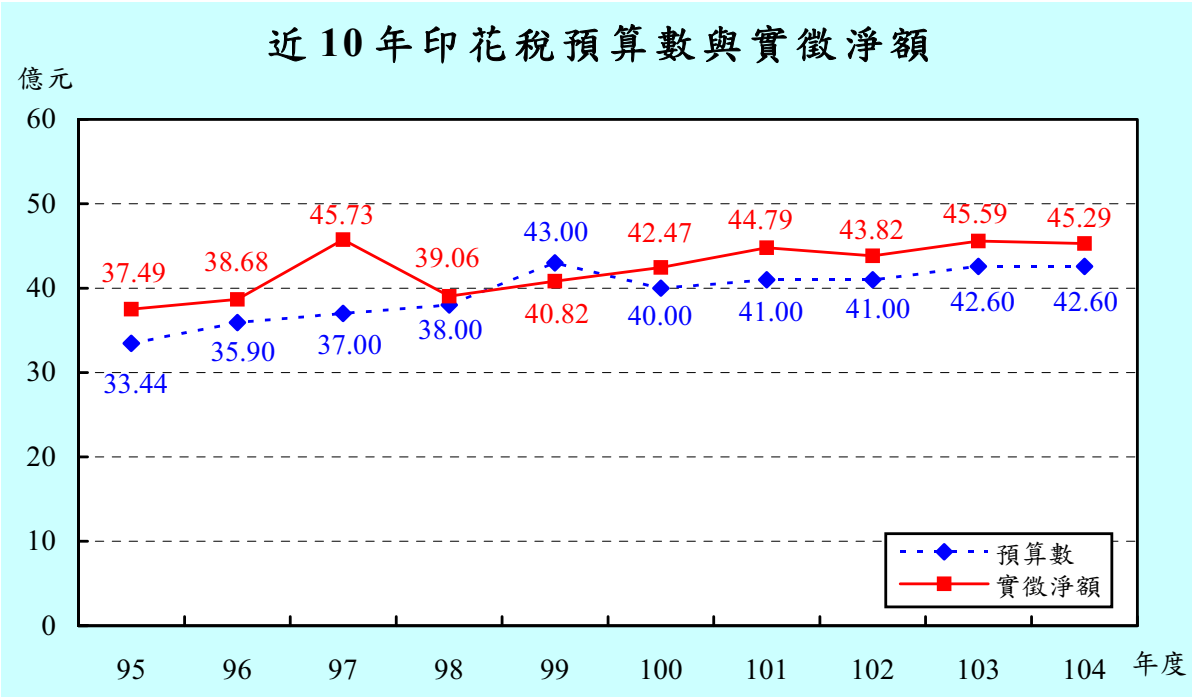

## 九、娛樂稅

104 年度實徵淨額 2.78 億元，與預算數 2.15 億元比較，增加 0.63 億元，超徵 29.3%；較上年度實徵淨額 2.35 億元增加 0.43 億元，成長 18.4%。

104 年度因舉辦臨時性娛樂表演活動較預期增多，致稅收超徵且較上年度增加。

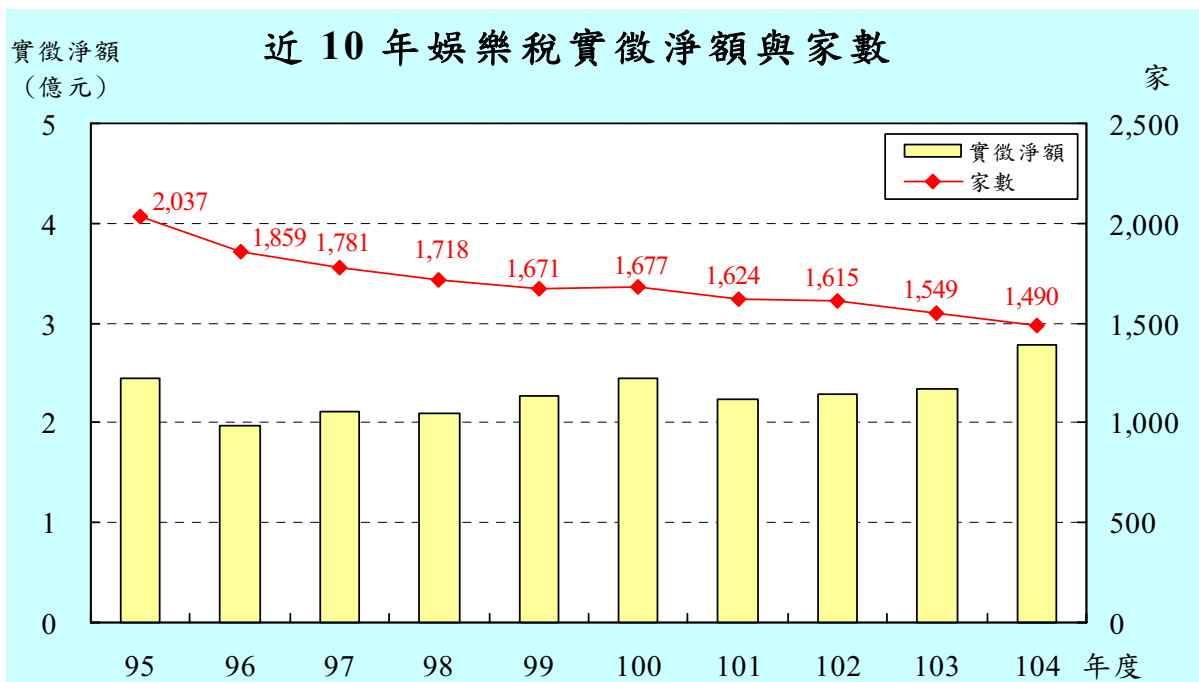
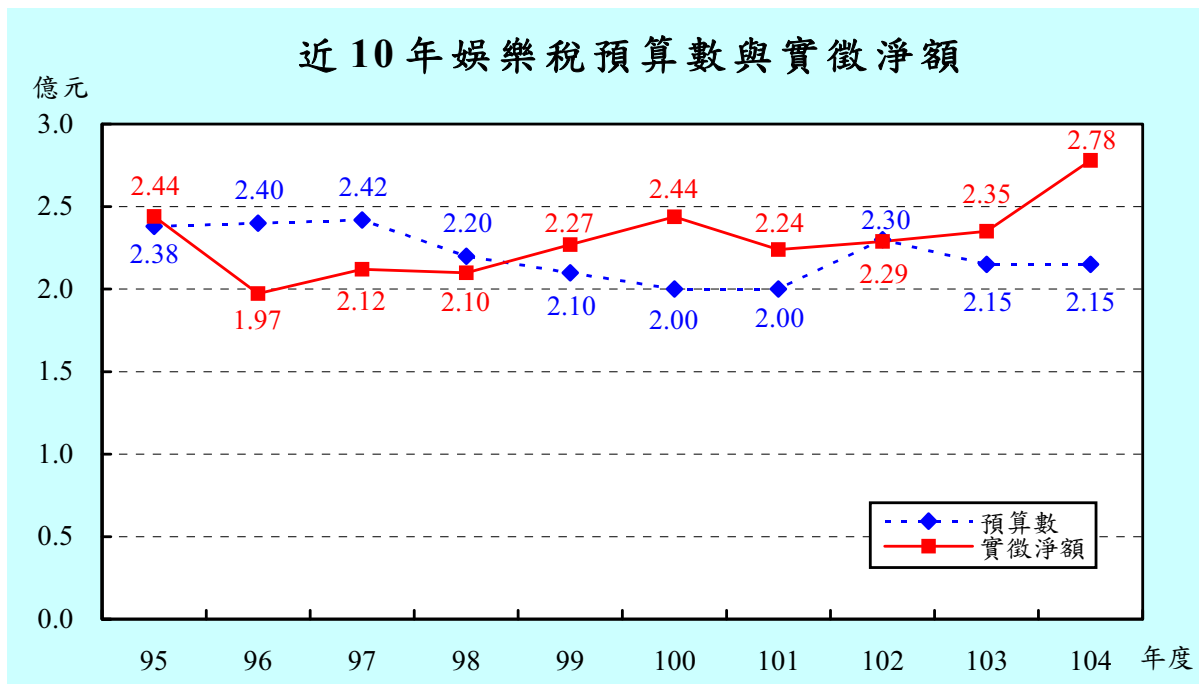

## 貳、稅收統計

## II . Tax Revenue Statistics

表 1 各項稅捐徵績比較

單位：新臺幣千元

稅目別 Item of Tax	104 年 度		FY 2015			
	預算數 Budget Amount	查定數① Audited Amount	實徵數② Actual Collection	退還以前 年度歲入款 Tax Income Returned	實徵淨額 Net Actual Collection	實徵數 占預算數 % Actual Collection/ Budget Amount
<b>總 計</b> <b>Grand Total</b>	<b>65,189,000</b>	<b>80,029,272</b>	<b>77,243,428</b>	<b>325,010</b>	<b>76,918,418</b>	<b>118.5</b>
稅 課 收 入 Revenues from Taxes	65,075,000	79,673,034	77,142,165	318,801	76,823,364	118.5
地 價 稅 Land Value Tax	21,800,000	23,120,367	22,089,792	49,642	22,040,150	101.3
土 地 增 值 稅 Land Value Increment Tax	17,600,000	26,935,058	26,011,486	243,621	25,767,865	147.8
房 屋 稅 House Tax	12,600,000	14,438,404	14,203,137	8,028	14,195,110	112.7
使 用 牌 照 稅 Vehicle License Tax	6,800,000	7,689,617	7,403,407	3,706	7,399,701	108.9
契 稅 Deed Tax	1,800,000	2,635,477	2,619,758	6,636	2,613,121	145.5
印 花 稅 Stamp Tax	4,260,000	4,564,574	4,536,481	7,141	4,529,341	106.5
娛 樂 稅 Amusement Tax	215,000	289,195	278,103	25	278,078	129.4
教 育 經 費 Education Surtax	—	343	—	2	- 2	--
工 程 受 益 費 Construction Benefit Fee	—	—	—	—	—	--
罰 鍰 收 入 Punitive Fine Revenue	114,000	356,238	101,263	6,209	95,054	88.8
規 費 收 入 Fees Revenue	—	—	—	—	—	--
契 稅 監 證 費 Fees	—	—	—	—	—	--

資料來源：依據徵課會計報告編製。

附 註：①查定數包括以前年度結轉數。

②實徵數未含實物抵繳稅款(以遞延收入入帳)。

Table 1. Net Tax Revenues Compare

Unit : N.T.\$1,000

實徵淨額 占預算數 % Net Actual Collection/ Budget Amount	104 年度與 103 年度比較 Compare FY2015 with FY2014			103 年度與 102 年度比較 Compare FY2014 with FY2013		
	103 年度 實徵淨額 Net Actual Collection FY 2014	增 減 數 Amount	增 減 %	102 年度 實徵淨額 Net Actual Collection FY2013	增 減 數 Amount	增 減 %
<b>118.0</b>	<b>67,393,010</b>	<b>9,525,407</b>	<b>14.1</b>	<b>66,440,531</b>	<b>952,479</b>	<b>1.4</b>
118.1	67,291,124	9,532,240	14.2	66,310,719	980,405	1.5
101.1	22,447,955	-407,805	-1.8	22,086,331	361,624	1.6
146.4	19,067,007	6,700,858	35.1	18,972,794	94,213	0.5
112.7	12,217,134	1,977,975	16.2	11,976,047	241,087	2.0
108.8	7,113,878	285,823	4.0	6,950,094	163,784	2.4
145.2	1,650,636	962,485	58.3	1,714,951	- 64,315	-3.8
106.3	4,559,596	- 30,255	-0.7	4,381,501	178,095	4.1
129.3	234,875	43,203	18.4	228,927	5,947	2.6
--	43	- 45	--	74	- 31	-41.8
--	--	--	--	--	--	--
83.4	101,886	- 6,832	-6.7	129,812	- 27,926	- 21.5
--	--	--	--	--	--	--
--	--	--	--	--	--	--

表 2 歷年各項稅捐預算數、查定數與實徵數

## (一)總計①

單位：新臺幣元

年度(月)別 Fiscal Year (Month)	預算數 Budget Amount (A)	查定數 Audited Amount		
		合計 Total	本年度 Current FY	以前年度② Previous FY
95 年度 FY 2006	52,011,000,000	66,672,822,287	59,184,231,898	7,488,590,389
96 年度 FY 2007	53,276,009,000	68,462,333,538	62,102,868,839	6,359,464,699
97 年度 FY 2008	54,238,000,000	63,451,419,838	57,508,965,836	5,942,454,002
98 年度 FY 2009	53,721,000,000	62,756,930,153	57,011,890,023	5,745,040,130
99 年度 FY 2010	52,865,000,000	65,873,934,825	61,521,291,170	4,352,643,655
100 年度 FY 2011	56,422,260,000	65,754,247,039	61,847,950,043	3,906,296,996
101 年度 FY 2012	61,185,000,000	65,905,662,486	62,733,494,186	3,172,168,300
102 年度 FY 2013	60,561,000,000	69,598,903,684	66,719,824,179	2,879,079,505
103 年度 FY 2014	63,179,000,000	70,613,134,428	67,876,534,672	2,736,599,756
104 年度 FY 2015	65,189,000,000	80,029,271,522	77,287,400,028	2,741,871,494
1 月 Jan.	2,702,247,000	6,244,427,206	3,388,870,273	2,855,556,933
2 月 Feb.	1,618,538,000	2,298,557,901	2,306,327,571	- 7,769,670
3 月 Mar.	3,053,898,000	2,078,498,825	2,093,699,381	- 15,200,556
4 月 Apr.	5,361,871,000	8,072,655,222	8,071,434,319	1,220,903
5 月 May	11,796,896,000	15,997,911,032	15,997,153,157	757,875
6 月 June	6,991,866,000	1,738,120,884	1,737,670,853	450,031
7 月 July	2,774,438,000	3,229,415,176	3,221,300,447	8,114,729
8 月 Aug.	1,743,980,000	2,331,900,072	2,330,783,901	1,116,171
9 月 Sep.	2,027,529,000	2,338,624,793	2,333,815,636	4,809,157
10 月 Oct.	2,064,333,000	3,074,744,472	3,061,836,068	12,908,404
11 月 Nov.	14,352,838,000	25,059,571,114	25,186,126,304	- 126,555,190
12 月 Dec.	10,700,566,000	7,564,844,825	7,558,382,118	6,462,707

附註：①總計=稅課收入+工程受益費+罰鍰收入+規費收入(監證費)。

②包括以前年度結轉數。

③99年度起實徵數未含實物抵繳稅款(以遞延收入入帳)。

Table 2. Budget Amount, Audited Amount and Actual Collection  
in Recent Years

( I ) Grand Total ①

Unit : N.T.\$1

實 徵 數 Actual Collection ③			退還以前年度 歲入款 Tax Income Returned (4)	實徵淨額 Net Actual Collection (1-4=5)	實徵淨額 占預算數 % Net Actual Collection /Budget Amount (5/A)×100
合 計 Total (2+3=1)	本 年 度 Current FY (2)	以 前 年 度 Previous FY (3)			
59,935,082,828	57,140,304,656	2,794,778,172	375,940,451	59,559,142,377	114.5
62,211,212,658	60,107,595,743	2,103,616,915	330,261,624	61,880,951,034	116.2
57,349,343,608	55,240,378,164	2,108,965,444	595,865,819	56,753,477,789	104.6
57,906,303,509	55,585,418,083	2,320,885,426	408,280,057	57,498,023,452	107.0
61,412,898,686	59,915,978,897	1,496,919,789	507,663,766	60,905,234,920	115.2
62,364,742,945	60,525,743,015	1,838,999,930	205,300,912	62,159,442,033	110.2
62,751,393,789	61,392,970,041	1,358,423,748	444,487,791	62,306,905,998	101.8
66,673,882,137	65,467,820,238	1,206,061,899	233,351,037	66,440,531,100	109.7
67,721,827,234	66,736,988,776	984,838,458	328,817,075	67,393,010,159	106.7
77,243,428,036	76,180,207,363	1,063,220,673	325,010,445	76,918,417,591	118.0
3,219,307,968	2,909,984,884	309,323,084	101,848,671	3,117,459,297	115.4
1,717,171,179	1,656,296,481	60,874,698	33,528,067	1,683,643,112	104.0
3,013,293,286	2,873,125,787	140,167,499	30,469,360	2,982,823,926	97.7
5,395,743,543	5,292,955,550	102,787,993	23,302,518	5,372,441,025	100.2
11,830,853,317	11,780,145,526	50,707,791	22,346,722	11,808,506,595	100.1
7,913,959,641	7,879,594,429	34,365,212	31,100,620	7,882,859,021	112.7
3,435,732,067	3,400,813,966	34,918,101	24,348,474	3,411,383,593	123.0
2,350,545,808	2,314,819,751	35,726,057	15,268,601	2,335,277,207	133.9
2,487,929,249	2,468,609,711	19,319,538	7,218,677	2,480,710,572	122.4
2,730,286,286	2,640,391,457	89,894,829	11,900,461	2,718,385,825	131.7
14,571,792,796	14,551,769,665	20,023,131	15,735,065	14,556,057,731	101.4
18,576,812,896	18,411,700,156	165,112,740	7,943,209	18,568,869,687	173.5

表 2 歷年各項稅捐預算數、查定數與實徵數 (續1)

## (二)稅課收入

## 1. 合計

單位：新臺幣元

年度(月)別 Fiscal Year (Month)	預算數 Budget Amount (A)	查定數 Audited Amount		
		合計 Total	本年度 Current FY	以前年度 <sup>①</sup> Previous FY
95 年度 FY 2006	51,828,000,000	66,235,324,703	59,111,525,544	7,123,799,159
96 年度 FY 2007	53,093,009,000	68,020,104,766	61,976,402,641	6,043,702,125
97 年度 FY 2008	54,034,000,000	62,976,080,816	57,346,759,662	5,629,321,154
98 年度 FY 2009	53,520,000,000	62,262,066,305	56,854,450,564	5,407,615,741
99 年度 FY 2010	52,710,000,000	65,326,212,670	61,317,097,584	4,009,115,086
100 年度 FY 2011	56,268,260,000	65,190,790,529	61,714,468,538	3,476,321,991
101 年度 FY 2012	61,050,000,000	65,409,563,052	62,634,837,985	2,774,725,067
102 年度 FY 2013	60,430,000,000	69,105,259,084	66,618,323,432	2,486,935,652
103 年度 FY 2014	63,075,000,000	70,184,841,864	67,802,361,337	2,382,480,527
104 年度 FY 2015	65,075,000,000	79,673,033,591	77,226,086,170	2,446,947,421
1 月 Jan.	2,692,955,000	5,917,350,614	3,388,702,136	2,528,648,478
2 月 Feb.	1,613,270,000	2,294,983,155	2,305,959,912	- 10,976,757
3 月 Mar.	3,044,759,000	2,073,603,669	2,090,988,772	- 17,385,103
4 月 Apr.	5,354,803,000	8,062,942,148	8,063,200,430	- 258,282
5 月 May	11,785,786,000	15,990,817,112	15,992,993,181	- 2,176,069
6 月 June	6,982,050,000	1,727,439,906	1,731,337,876	- 3,897,970
7 月 July	2,765,555,000	3,221,924,050	3,216,856,172	5,067,878
8 月 Aug.	1,734,127,000	2,328,214,016	2,327,851,035	362,981
9 月 Sep.	2,022,362,000	2,330,717,153	2,326,835,737	3,881,416
10 月 Oct.	2,057,664,000	3,067,213,507	3,056,803,037	10,410,470
11 月 Nov.	14,342,854,000	25,106,528,681	25,178,492,443	- 71,963,762
12 月 Dec.	10,678,815,000	7,551,299,580	7,546,065,439	5,234,141

附註：①包括以前年度結轉數。

②99年度起實徵數未含實物抵繳稅款(以遞延收入入帳)。

Table 2. Budget Amount, Audited Amount and Actual Collection  
in Recent Years (Cont. 1)

( II ) Revenues from Taxes

1. Total

Unit : N.T.\$1

實 徵 數 Actual Collection ②			退還以前年度 歲入款 Tax Income Returned (4)	實 徵 淨 額 Net Actual Collection (1-4=5)	實徵淨額 占預算數 % Net Actual Collection /Budge Amount (5/A)×100
合 計 Total (2+3=1)	本 年 度 Current FY (2)	以 前 年 度 Previous FY (3)			
59,704,949,774	57,086,468,516	2,618,481,258	371,162,603	59,333,787,171	114.5
62,019,116,746	60,048,819,696	1,970,297,050	323,317,992	61,695,798,754	116.2
57,157,456,189	55,176,188,981	1,981,267,208	586,921,874	56,570,534,315	104.7
57,706,501,696	55,526,927,616	2,179,574,080	361,017,806	57,345,483,890	107.1
61,246,934,737	59,853,800,575	1,393,134,162	402,019,755	60,844,914,982	115.4
62,176,573,002	60,466,079,308	1,710,493,694	177,305,299	61,999,267,703	110.2
62,620,652,883	61,349,810,533	1,270,842,350	431,514,478	62,189,138,405	101.9
66,530,700,040	65,412,535,691	1,118,164,349	219,980,597	66,310,719,443	109.7
67,616,183,545	66,695,912,290	920,271,255	325,059,274	67,291,124,271	106.7
77,142,165,141	76,138,178,495	1,003,986,646	318,801,340	76,823,363,801	118.1
3,212,289,062	2,909,865,012	302,424,050	100,732,848	3,111,556,214	115.5
1,711,754,651	1,655,966,648	55,788,003	32,689,130	1,679,065,521	104.1
3,006,817,282	2,871,361,220	135,456,062	30,069,368	2,976,747,914	97.8
5,386,442,632	5,287,936,133	98,506,499	23,077,621	5,363,365,011	100.2
11,820,650,463	11,775,107,209	45,543,254	21,832,755	11,798,817,708	100.1
7,903,031,093	7,875,159,464	27,871,629	30,660,540	7,872,370,553	112.8
3,426,818,930	3,397,583,826	29,235,104	23,767,574	3,403,051,356	123.1
2,344,394,136	2,312,244,299	32,149,837	14,253,699	2,330,140,437	134.4
2,479,311,674	2,464,349,081	14,962,593	7,090,428	2,472,221,246	122.2
2,722,492,944	2,637,531,014	84,961,930	11,612,787	2,710,880,157	131.7
14,563,359,880	14,547,369,109	15,990,771	15,458,478	14,547,901,402	101.4
18,564,802,394	18,403,705,480	161,096,914	7,556,112	18,557,246,282	173.8

表 2 歷年各項稅捐預算數、查定數與實徵數 (續2)

## (二)稅課收入

## 2. 地價稅

單位：新臺幣元

年度(月)別 Fiscal Year (Month)	預算數 Budget Amount (A)	查定數 Audited Amount		
		合計 Total	本年度 Current FY	以前年度 Previous FY
95 年度 FY 2006	16,841,000,000	20,877,369,503	17,631,744,847	3,245,624,656
96 年度 FY 2007	17,037,000,000	22,406,238,656	19,665,335,019	2,740,903,637
97 年度 FY 2008	17,600,000,000	21,622,348,590	18,962,431,757	2,659,916,833
98 年度 FY 2009	17,800,000,000	20,775,773,127	18,637,378,171	2,138,394,956
99 年度 FY 2010	18,000,000,000	22,108,091,007	20,315,591,574	1,792,499,433
100 年度 FY 2011	18,400,000,000	21,729,735,988	20,213,024,931	1,516,711,057
101 年度 FY 2012	19,500,000,000	21,916,615,715	20,793,949,827	1,122,665,888
102 年度 FY 2013	21,900,000,000	23,134,506,730	22,091,728,224	1,042,778,506
103 年度 FY 2014	21,200,000,000	23,465,985,406	22,555,658,532	910,326,874
104 年度 FY 2015	21,800,000,000	23,120,367,032	22,199,044,067	921,322,965
1 月 Jan.	67,313,000	951,751,220	13,108,030	938,643,190
2 月 Feb.	39,782,000	21,666,613	20,962,339	704,274
3 月 Mar.	195,766,000	18,837,490	20,483,965	- 1,646,475
4 月 Apr.	108,433,000	31,173,092	30,654,095	518,997
5 月 May	622,122,000	2,500,581	3,319,751	- 819,170
6 月 June	38,244,000	9,310,913	12,764,932	- 3,454,019
7 月 July	19,869,000	11,936,809	10,985,694	951,115
8 月 Aug.	27,420,000	17,207,239	17,191,257	15,982
9 月 Sep.	16,087,000	11,762,818	11,950,157	- 187,339
10 月 Oct.	458,771,000	212,206,188	212,265,254	- 59,066
11 月 Nov.	11,695,743,000	21,836,746,516	21,842,976,370	- 6,229,854
12 月 Dec.	8,510,450,000	-4,732,447	2,382,223	- 7,114,670

Table 2. Budget Amount, Audited Amount and Actual Collection  
in Recent Years (Cont. 2)

## ( II ) Revenues from Taxes

## 2. Land Value Tax

Unit : N.T.\$1

實徵數 Actual Collection			退還以前年度 歲入款 Tax Income Returned (4)	實徵淨額 Net Actual Collection (1-4=5)	實徵淨額 占預算數 % Net Actual Collection /Budge Amount (5/A)×100
合計 Total (2+3=1)	本年度 Current FY (2)	以前年度 Previous FY (3)			
17,966,408,173	16,742,406,708	1,224,001,465	65,594,730	17,900,813,443	106.3
19,562,228,351	18,649,206,309	913,022,042	93,531,178	19,468,697,173	114.3
19,336,852,287	18,205,651,270	1,131,201,017	148,458,460	19,188,393,827	109.0
18,836,109,030	18,029,123,615	806,985,415	133,715,429	18,702,393,601	105.1
20,332,765,697	19,623,815,795	708,949,902	41,724,158	20,291,041,539	112.7
20,534,137,009	19,743,790,367	790,346,642	28,928,504	20,505,208,505	111.4
20,748,021,644	20,243,111,064	504,910,580	77,497,739	20,670,523,905	106.0
22,143,481,947	21,644,233,803	499,248,144	57,150,883	22,086,331,064	100.9
22,520,360,611	22,125,335,251	395,025,360	72,405,760	22,447,954,851	105.9
22,089,792,483	21,715,846,880	373,945,603	49,642,280	22,040,150,203	101.1
89,079,454	12,142,702	76,936,752	6,379,096	82,700,358	122.9
38,247,780	6,063,123	32,184,657	7,150,389	31,097,391	78.2
84,804,576	11,536,841	73,267,735	3,636,956	81,167,620	41.5
116,057,343	34,462,677	81,594,666	8,710,250	107,347,093	99.0
35,135,082	6,892,586	28,242,496	4,624,657	30,510,425	4.9
21,983,094	7,327,498	14,655,596	6,141,582	15,841,512	41.4
20,648,104	6,380,829	14,267,275	989,768	19,658,336	98.9
21,025,887	11,283,771	9,742,116	1,105,805	19,920,082	72.6
33,973,474	26,868,476	7,104,998	77,035	33,896,439	210.7
233,990,529	218,713,111	15,277,418	367,134	233,623,395	50.9
10,867,518,866	10,861,551,999	5,966,867	9,488,033	10,858,030,833	92.8
10,527,328,294	10,512,623,267	14,705,027	971,575	10,526,356,719	123.7

表 2 歷年各項稅捐預算數、查定數與實徵數 (續3)

## (二)稅課收入

## 3. 土地增值稅

單位：新臺幣元

年度(月)別 Fiscal Year (Month)	預算數 Budget Amount (A)	查定數 Audited Amount		
		合計 Total	本年度 Current FY	以前年度 Previous FY
95 年度 FY 2006	13,800,000,000	20,479,966,834	18,573,005,660	1,906,961,174
96 年度 FY 2007	14,271,009,000	20,581,406,339	19,082,471,654	1,498,934,685
97 年度 FY 2008	14,400,000,000	15,838,196,306	14,501,930,736	1,336,265,570
98 年度 FY 2009	13,500,000,000	16,754,143,332	14,953,917,653	1,800,225,679
99 年度 FY 2010	12,000,000,000	18,231,273,864	17,212,755,478	1,018,518,386
100 年度 FY 2011	15,000,000,000	18,530,330,855	17,550,051,311	980,279,544
101 年度 FY 2012	17,000,000,000	17,566,789,041	16,633,841,191	932,947,850
102 年度 FY 2013	14,200,000,000	20,013,739,423	19,214,772,442	798,966,981
103 年度 FY 2014	17,000,000,000	20,373,582,528	19,505,216,701	868,365,827
104 年度 FY 2015	17,600,000,000	26,935,057,700	25,913,549,898	1,021,507,802
1 月 Jan.	1,649,120,000	3,394,571,150	2,350,955,070	1,043,616,080
2 月 Feb.	1,191,520,000	1,869,904,554	1,878,968,671	- 9,064,117
3 月 Mar.	1,675,520,000	855,896,348	871,310,326	- 15,413,978
4 月 Apr.	1,268,960,000	1,288,872,149	1,288,857,401	14,748
5 月 May	1,540,000,000	1,464,037,212	1,464,785,441	- 748,229
6 月 June	1,420,320,000	1,319,645,996	1,317,863,972	1,782,024
7 月 July	1,731,840,000	2,256,700,214	2,253,084,109	3,616,105
8 月 Aug.	1,277,760,000	1,706,116,586	1,706,116,586	-
9 月 Sep.	1,182,720,000	1,367,666,566	1,363,715,334	3,951,232
10 月 Oct.	1,193,280,000	2,161,442,072	2,150,842,275	10,599,797
11 月 Nov.	1,642,080,000	2,416,947,435	2,446,855,402	- 29,907,967
12 月 Dec.	1,826,880,000	6,833,257,418	6,820,195,311	13,062,107

Table 2. Budget Amount, Audited Amount and Actual Collection  
in Recent Years (Cont. 3)

## (II) Revenues from Taxes

## 3. Land Value Increment Tax

Unit : N.T.\$1

實徵數 Actual Collection			退還以前年度 歲入款 Tax Income Returned (4)	實徵淨額 Net Actual Collection (1-4=5)	實徵淨額 占預算數 % Net Actual Collection /Budge Amount (5/A)×100
合計 Total (2+3=1)	本年度 Current FY (2)	以前年度 Previous FY (3)			
18,880,808,661	17,906,518,152	974,290,509	272,719,849	18,608,088,812	134.8
19,209,882,958	18,552,463,723	657,419,235	172,100,151	19,037,782,807	133.4
13,943,736,263	13,477,042,093	466,694,170	394,326,670	13,549,409,593	94.1
15,609,940,194	14,555,621,276	1,054,318,918	196,024,352	15,413,915,842	114.2
17,088,982,865	16,718,462,793	370,520,072	204,092,581	16,884,890,284	140.7
17,528,534,334	16,992,903,207	535,631,127	121,268,101	17,407,266,233	116.0
16,674,777,843	16,137,848,941	536,928,902	277,563,791	16,397,214,052	96.5
19,103,840,213	18,728,768,054	375,072,159	131,046,359	18,972,793,854	133.6
19,303,115,028	19,066,215,194	236,899,834	236,107,832	19,067,007,196	112.2
26,011,486,168	25,568,874,128	442,612,040	243,621,242	25,767,864,926	146.4
2,116,193,237	1,959,296,665	156,896,572	79,955,076	2,036,238,161	123.5
1,296,464,185	1,286,906,343	9,557,842	24,450,324	1,272,013,861	106.8
1,664,073,591	1,615,866,468	48,207,123	25,486,495	1,638,587,096	97.8
1,213,607,768	1,207,145,887	6,461,881	14,058,976	1,199,548,792	94.5
1,340,151,600	1,334,019,019	6,132,581	16,403,706	1,323,747,894	86.0
1,438,866,075	1,433,101,453	5,764,622	23,738,430	1,415,127,645	99.6
2,244,072,747	2,239,625,287	4,447,460	21,834,809	2,222,237,938	128.3
1,601,200,879	1,586,224,409	14,976,470	8,749,986	1,592,450,893	124.6
1,373,003,655	1,370,301,965	2,701,690	6,295,221	1,366,708,434	115.6
1,955,192,779	1,914,754,648	40,438,131	10,919,965	1,944,272,814	162.9
2,531,478,447	2,526,877,706	4,600,741	5,771,813	2,525,706,634	153.8
7,237,181,205	7,094,754,278	142,426,927	5,956,441	7,231,224,764	395.8

表 2 歷年各項稅捐預算數、查定數與實徵數 (續4)

## (二)稅課收入

## 4. 房屋稅

單位：新臺幣元

年度(月)別 Fiscal Year (Month)	預算數 Budget Amount (A)	查定數 Audited Amount		
		合計 Total	本年度 Current FY	以前年度 Previous FY
95 年度 FY 2006	9,641,000,000	11,066,349,485	9,998,789,101	1,067,560,384
96 年度 FY 2007	9,750,000,000	11,110,055,367	10,093,474,972	1,016,580,395
97 年度 FY 2008	9,800,000,000	11,078,405,809	10,126,254,227	952,151,582
98 年度 FY 2009	9,900,000,000	11,165,748,863	10,287,985,782	877,763,081
99 年度 FY 2010	10,000,000,000	11,216,744,220	10,584,535,806	632,208,414
100 年度 FY 2011	10,268,260,000	11,195,589,644	10,724,497,031	471,092,613
101 年度 FY 2012	11,400,000,000	12,145,931,799	11,853,364,805	292,566,994
102 年度 FY 2013	11,600,000,000	12,242,328,975	11,981,068,357	261,260,618
103 年度 FY 2014	12,000,000,000	12,425,932,774	12,183,993,065	241,939,709
104 年度 FY 2015	12,600,000,000	14,438,403,941	14,239,602,056	198,801,885
1 月 Jan.	23,692,000	225,709,245	24,953,472	200,755,773
2 月 Feb.	61,858,000	22,520,706	22,177,926	342,780
3 月 Mar.	54,763,000	62,749,181	62,754,127	- 4,946
4 月 Apr.	395,072,000	216,305,272	216,359,402	- 54,130
5 月 May	6,688,837,000	13,628,323,152	13,628,386,833	- 63,681
6 月 June	5,174,143,000	148,402,291	149,976,020	- 1,573,729
7 月 July	63,879,000	9,757,439	9,470,096	287,343
8 月 Aug.	47,356,000	30,800,264	30,715,724	84,540
9 月 Sep.	40,701,000	23,002,054	23,015,899	- 13,845
10 月 Oct.	16,566,000	12,296,026	12,294,098	1,928
11 月 Nov.	16,567,000	-263,983	779,117	- 1,043,100
12 月 Dec.	16,566,000	58,802,294	58,719,342	82,952

Table 2. Budget Amount, Audited Amount and Actual Collection  
in Recent Years (Cont. 4)

( II ) Revenues from Taxes

4. House Tax

Unit : N.T.\$1

實徵數 Actual Collection			退還以前年度 歲入款 Tax Income Returned (4)	實徵淨額 Net Actual Collection (1-4=5)	實徵淨額 占預算數 % Net Actual Collection /Budge Amount (5/A)×100
合計 Total (2+3=1)	本年度 Current FY (2)	以前年度 Previous FY (3)			
10,008,945,199	9,801,976,281	206,968,918	11,239,378	9,997,705,821	103.7
10,107,330,035	9,936,615,687	170,714,348	16,058,978	10,091,271,057	103.5
10,147,929,725	9,971,769,272	176,160,453	7,309,474	10,140,620,251	103.5
10,307,459,162	10,167,653,129	139,806,033	11,972,825	10,295,486,337	104.0
10,627,295,631	10,486,926,494	140,369,137	126,758,102	10,500,537,529	105.0
10,873,867,433	10,640,949,149	232,918,284	8,744,070	10,865,123,363	105.8
11,869,544,305	11,765,750,542	103,793,763	9,609,521	11,859,934,784	104.0
11,997,380,436	11,884,758,971	112,621,465	21,333,121	11,976,047,315	103.2
12,221,541,822	12,093,853,815	127,688,007	4,407,746	12,217,134,076	101.8
14,203,137,405	14,137,990,927	65,146,478	8,028,056	14,195,109,349	112.7
35,281,627	20,744,675	14,536,952	735,008	34,546,619	145.8
21,190,597	15,923,406	5,267,191	46,373	21,144,224	34.2
33,918,231	29,916,219	4,002,012	587,673	33,330,558	60.9
258,801,205	256,468,715	2,332,490	98,822	258,702,383	65.5
7,308,835,153	7,306,192,561	2,642,592	59,770	7,308,775,383	109.3
6,046,887,476	6,044,576,650	2,310,826	583,722	6,046,303,754	116.9
158,961,839	156,030,885	2,930,954	396,613	158,565,226	248.2
65,526,014	63,153,087	2,372,927	4,076,581	61,449,433	129.8
97,699,966	95,931,394	1,768,572	686,455	97,013,511	238.4
101,676,312	76,521,964	25,154,348	196,162	101,480,150	612.6
9,429,638	8,289,858	1,139,780	76,487	9,353,151	56.5
64,929,347	64,241,513	687,834	484,390	64,444,957	389.0

表 2 歷年各項稅捐預算數、查定數與實徵數 (續5)

## (二)稅課收入

## 5. 使用牌照稅

單位：新臺幣元

年度(月)別 Fiscal Year (Month)	預算數 Budget Amount (A)	查定數 Audited Amount		
		合計 Total	本年度 Current FY	以前年度 Previous FY
95 年度 FY 2006	6,390,000,000	7,279,956,795	6,501,992,897	777,963,898
96 年度 FY 2007	6,585,000,000	7,236,551,078	6,569,504,486	667,046,592
97 年度 FY 2008	6,592,000,000	7,146,127,212	6,566,865,409	579,261,803
98 年度 FY 2009	6,500,000,000	7,003,421,917	6,486,376,074	517,045,843
99 年度 FY 2010	6,300,000,000	7,057,513,192	6,557,727,685	499,785,507
100 年度 FY 2011	6,400,000,000	7,172,227,550	6,720,258,884	451,968,666
101 年度 FY 2012	6,450,000,000	7,210,013,827	6,833,694,476	376,319,351
102 年度 FY 2013	6,600,000,000	7,286,652,627	6,966,480,016	320,172,611
103 年度 FY 2014	6,600,000,000	7,407,801,179	7,137,466,677	270,334,502
104 年度 FY 2015	6,800,000,000	7,689,616,970	7,436,140,040	253,476,930
1 月 Jan.	124,986,000	416,854,539	127,846,943	289,007,596
2 月 Feb.	78,151,000	79,204,051	77,999,872	1,204,179
3 月 Mar.	372,274,000	411,121,015	411,191,580	- 70,565
4 月 Apr.	3,337,033,000	6,322,450,692	6,322,974,032	- 523,340
5 月 May	2,190,376,000	33,674,592	34,311,401	- 636,809
6 月 June	77,384,000	4,148,122	4,581,648	- 433,526
7 月 July	113,291,000	33,869,488	33,656,492	212,996
8 月 Aug.	73,614,000	16,989,364	16,757,659	231,705
9 月 Sep.	43,708,000	17,210,527	17,269,023	- 58,496
10 月 Oct.	120,921,000	376,107,965	376,265,903	- 157,938
11 月 Nov.	242,846,000	-22,024,548	12,467,099	- 34,491,647
12 月 Dec.	25,416,000	11,163	818,388	- 807,225

Table 2. Budget Amount, Audited Amount and Actual Collection  
in Recent Years (Cont. 5)

## ( II ) Revenues from Taxes

## 5. Vehicle License Tax

Unit : N.T.\$1

實徵數 Actual Collection			退還以前年度 歲入款 Tax Income Returned	實徵淨額 Net Actual Collection	實徵淨額 占預算數 % Net Actual Collection /Budge Amount (5/A)×100
合計 Total (2+3=1)	本年度 Current FY (2)	以前年度 Previous FY (3)			
6,456,855,906	6,282,770,037	174,085,869	14,106,973	6,442,748,933	100.8
6,570,266,092	6,387,577,512	182,688,580	8,119,825	6,562,146,267	99.7
6,557,721,371	6,391,932,046	165,789,325	21,283,375	6,536,437,996	99.2
6,471,544,379	6,327,495,599	144,048,780	9,534,915	6,462,009,464	99.4
6,555,896,936	6,423,796,664	132,100,272	13,827,036	6,542,069,900	103.8
6,734,678,663	6,623,516,937	111,161,726	7,912,188	6,726,766,475	105.1
6,833,177,948	6,746,233,733	86,944,215	5,451,652	6,827,726,296	105.9
6,955,441,436	6,877,052,975	78,388,461	5,347,283	6,950,094,153	105.3
7,118,817,681	7,040,294,793	78,522,888	4,939,003	7,113,878,678	107.8
7,403,407,388	7,323,486,127	79,921,261	3,706,191	7,399,701,197	108.8
120,326,060	106,406,607	13,919,453	2,019,099	118,306,961	94.7
103,584,185	93,718,022	9,866,163	502,542	103,081,643	131.9
415,234,250	405,680,626	9,553,624	144,355	415,089,895	111.5
3,591,425,159	3,583,511,178	7,913,981	123,113	3,591,302,046	107.6
2,362,972,233	2,355,359,219	7,613,014	81,665	2,362,890,568	107.9
87,477,504	82,252,608	5,224,896	107,007	87,370,497	112.9
105,296,878	97,734,948	7,561,930	188,396	105,108,482	92.8
90,182,741	85,169,072	5,013,669	287,458	89,895,283	122.1
63,390,075	60,376,994	3,013,081	10,494	63,379,581	145.0
119,865,370	115,898,521	3,966,849	83,877	119,781,493	99.1
319,003,321	315,969,871	3,033,450	28,734	318,974,587	131.3
24,649,612	21,408,461	3,241,151	129,451	24,520,161	96.5

表 2 歷年各項稅捐預算數、查定數與實徵數 (續6)

## (二)稅課收入

## 6. 契稅

單位：新臺幣元

年度(月)別 Fiscal Year (Month)	預算數 Budget Amount (A)	查定數 Audited Amount		
		合計 Total	本年度 Current FY	以前年度 Previous FY
95 年度 FY 2006	1,574,000,000	2,437,482,207	2,404,929,193	32,553,014
96 年度 FY 2007	1,620,000,000	2,505,084,139	2,471,335,039	33,749,100
97 年度 FY 2008	1,700,000,000	2,400,691,064	2,376,222,441	24,468,623
98 年度 FY 2009	1,800,000,000	2,387,423,390	2,370,494,063	16,929,327
99 年度 FY 2010	1,900,000,000	2,354,950,169	2,335,370,733	19,579,436
100 年度 FY 2011	2,000,000,000	2,024,703,077	2,004,885,156	19,817,921
101 年度 FY 2012	2,400,000,000	1,801,127,687	1,789,084,593	12,043,094
102 年度 FY 2013	1,800,000,000	1,734,852,208	1,715,325,749	19,526,459
103 年度 FY 2014	1,800,000,000	1,681,135,183	1,666,281,819	14,853,364
104 年度 FY 2015	1,800,000,000	2,635,476,618	2,615,259,099	20,217,519
1 月 Jan.	163,317,000	227,396,172	203,268,618	24,127,554
2 月 Feb.	115,132,000	210,333,776	213,928,773	- 3,594,997
3 月 Mar.	155,364,000	108,641,725	108,653,181	- 11,456
4 月 Apr.	144,365,000	106,641,403	106,650,763	- 9,360
5 月 May	142,300,000	221,212,914	221,210,013	2,901
6 月 June	131,087,000	120,016,532	120,179,327	- 162,795
7 月 July	166,492,000	184,290,192	184,290,192	—
8 月 Aug.	151,665,000	391,303,363	391,303,363	—
9 月 Sep.	122,274,000	176,389,542	176,389,542	—
10 月 Oct.	158,552,000	168,747,624	168,747,624	—
11 月 Nov.	170,603,000	246,852,533	246,986,123	- 133,590
12 月 Dec.	178,849,000	473,650,842	473,651,580	- 738

Table 2. Budget Amount, Audited Amount and Actual Collection  
in Recent Years (Cont. 6)

( II ) Revenues from Taxes

6.Deed Tax

Unit : N.T.\$1

實徵數 Actual Collection			退還以前年度 歲入款 Tax Income Returned	實徵淨額 Net Actual Collection	實徵淨額 占預算數 % Net Actual Collection /Budge Amount (5/A)×100
合計 Total (2+3=1)	本年度 Current FY (2)	以前年度 Previous FY (3)			
2,395,511,426	2,372,214,627	23,296,799	5,651,175	2,389,860,251	151.8
2,482,531,926	2,455,891,723	26,640,203	13,565,211	2,468,966,715	152.4
2,373,419,350	2,355,450,922	17,968,428	4,332,477	2,369,086,873	139.4
2,362,740,281	2,349,557,652	13,182,629	5,738,532	2,357,001,749	130.9
2,331,574,422	2,314,250,777	17,323,645	4,427,193	2,327,147,229	122.5
2,009,354,997	1,990,445,604	18,909,393	5,023,858	2,004,331,139	100.2
1,779,320,448	1,767,832,856	11,487,592	48,554,638	1,730,765,810	72.1
1,718,308,296	1,699,547,000	18,761,296	3,357,047	1,714,951,249	95.3
1,656,050,355	1,641,731,846	14,318,509	5,414,521	1,650,635,834	91.7
2,619,757,703	2,599,963,241	19,794,462	6,636,420	2,613,121,283	145.2
195,318,191	172,670,785	22,647,406	5,269,167	190,049,024	116.4
151,079,001	153,953,262	-2,874,261	354,502	150,724,499	130.9
189,251,959	189,183,704	68,255	171,831	189,080,128	121.7
105,892,510	105,842,626	49,884	70,689	105,821,821	73.3
140,251,249	140,211,199	40,050	157,784	140,093,465	98.4
172,840,912	172,977,046	-136,134	85,914	172,754,998	131.8
185,261,410	185,261,410	—	357,515	184,903,895	111.1
395,285,146	395,285,146	—	9,277	395,275,869	260.6
183,203,448	183,203,448	—	21,211	183,182,237	149.8
173,032,884	173,032,884	—	45,119	172,987,765	109.1
214,822,351	214,822,351	—	93,411	214,728,940	125.9
513,518,642	513,519,380	- 738	—	513,518,642	287.1

表 2 歷年各項稅捐預算數、查定數與實徵數 (續7)

## (二)稅課收入

## 7. 印花稅

單位：新臺幣元

年度(月)別 Fiscal Year (Month)	預算數 Budget Amount (A)	查定數 Audited Amount		
		合計 Total	本年度 Current FY	以前年度 Previous FY
95 年度 FY 2006	3,344,000,000	3,766,379,307	3,755,601,122	10,778,185
96 年度 FY 2007	3,590,000,000	3,888,454,981	3,873,555,888	14,899,093
97 年度 FY 2008	3,700,000,000	4,609,282,181	4,588,774,708	20,507,473
98 年度 FY 2009	3,800,000,000	3,925,051,668	3,906,121,491	18,930,177
99 年度 FY 2010	4,300,000,000	4,104,312,940	4,082,135,308	22,177,632
100 年度 FY 2011	4,000,000,000	4,276,000,815	4,256,320,858	19,679,957
101 年度 FY 2012	4,100,000,000	4,528,289,507	4,503,633,420	24,656,087
102 年度 FY 2013	4,100,000,000	4,450,816,446	4,420,195,497	30,620,949
103 年度 FY 2014	4,260,000,000	4,582,705,985	4,517,168,088	65,537,897
104 年度 FY 2015	4,260,000,000	4,564,573,534	4,544,318,777	20,254,757
1 月 Jan.	647,323,000	667,381,336	647,411,414	19,969,922
2 月 Feb.	103,814,000	74,227,247	74,866,396	- 639,149
3 月 Mar.	576,121,000	595,794,006	596,035,853	- 241,847
4 月 Apr.	82,605,000	75,047,481	75,236,196	- 188,715
5 月 May	586,719,000	614,892,967	614,866,807	26,160
6 月 June	123,377,000	102,573,024	102,626,740	- 53,716
7 月 July	648,216,000	702,444,654	702,444,651	3
8 月 Aug.	136,910,000	146,333,171	146,302,021	31,150
9 月 Sep.	595,478,000	696,914,685	696,724,821	189,864
10 月 Oct.	93,573,000	107,789,806	107,761,743	28,063
11 月 Nov.	561,654,000	611,767,613	610,649,610	1,118,003
12 月 Dec.	104,210,000	169,407,544	169,392,525	15,019

Table 2. Budget Amount, Audited Amount and Actual Collection  
in Recent Years (Cont. 7)

## ( II ) Revenues from Taxes

## 7. Stamp Tax

Unit : N.T.\$1

實徵數 Actual Collection			退還以前年度 歲入款 Tax Income Returned	實徵淨額 Net Actual Collection	實徵淨額 占預算數 % Net Actual Collection /Budge Amount (5/A)×100
合計 Total (2+3=1)	本年度 Current FY (2)	以前年度 Previous FY (3)			
3,751,018,926	3,741,648,032	9,370,894	1,713,858	3,749,305,068	112.1
3,868,754,971	3,854,892,522	13,862,449	437,622	3,868,317,349	107.8
4,575,045,907	4,555,749,565	19,296,342	1,704,717	4,573,341,190	123.6
3,908,255,404	3,890,354,445	17,900,959	2,724,686	3,905,530,718	102.8
4,082,809,119	4,061,562,012	21,247,107	492,895	4,082,316,224	94.9
4,251,545,414	4,232,189,023	19,356,391	4,783,867	4,246,761,547	106.2
4,490,891,015	4,466,449,592	24,441,423	12,319,234	4,478,571,781	109.2
4,383,222,779	4,352,816,494	30,406,285	1,721,851	4,381,500,928	106.9
4,561,138,863	4,495,847,841	65,291,022	1,542,838	4,559,596,025	107.0
4,536,481,104	4,516,226,347	20,254,757	7,140,578	4,529,340,526	106.3
636,180,948	619,076,524	17,104,424	6,373,073	629,807,875	97.3
84,406,097	82,840,491	1,565,606	184,861	84,221,236	81.1
598,040,905	598,034,908	5,997	42,058	597,998,847	103.8
78,832,301	78,789,417	42,884	5,205	78,827,096	95.4
611,915,150	611,888,342	26,808	503,801	611,411,349	104.2
105,830,665	105,845,324	- 14,659	3,885	105,826,780	85.8
689,541,936	689,541,933	3	—	689,541,936	106.4
151,712,031	151,711,843	188	14,754	151,697,277	110.8
691,451,198	691,090,691	360,507	12	691,451,186	116.1
110,691,679	110,662,294	29,385	—	110,691,679	118.3
601,602,302	600,483,707	1,118,595	—	601,602,302	107.1
176,275,892	176,260,873	15,019	12,929	176,262,963	169.1

表 2 歷年各項稅捐預算數、查定數與實徵數 (續8)

## (二)稅課收入

## 8. 娛樂稅

單位：新臺幣元

年度(月)別 Fiscal Year (Month)	預算數 Budget Amount (A)	查定數 Audited Amount		
		合計 Total	本年度 Current FY	以前年度 Previous FY
95 年度 FY 2006	238,000,000	305,881,025	245,462,724	60,418,301
96 年度 FY 2007	240,000,000	275,783,980	220,725,583	55,058,397
97 年度 FY 2008	242,000,000	268,489,788	224,280,384	44,209,404
98 年度 FY 2009	220,000,000	242,229,432	212,177,330	30,052,102
99 年度 FY 2010	210,000,000	248,327,528	228,981,000	19,346,528
100 年度 FY 2011	200,000,000	259,975,890	245,430,367	14,545,523
101 年度 FY 2012	200,000,000	239,594,695	227,269,673	12,325,022
102 年度 FY 2013	230,000,000	241,617,104	228,753,147	12,863,957
103 年度 FY 2014	215,000,000	247,274,144	236,576,455	10,697,689
104 年度 FY 2015	215,000,000	289,194,798	278,172,233	11,022,565
1 月 Jan.	17,204,000	33,343,954	21,158,589	12,185,365
2 月 Feb.	23,013,000	17,126,208	17,055,935	70,273
3 月 Mar.	14,951,000	20,563,904	20,559,740	4,164
4 月 Apr.	18,335,000	22,452,059	22,468,541	- 16,482
5 月 May	15,432,000	26,175,694	26,112,935	62,759
6 月 June	17,495,000	23,343,028	23,345,237	- 2,209
7 月 July	21,968,000	22,925,254	22,924,938	316
8 月 Aug.	19,402,000	19,464,029	19,464,425	- 396
9 月 Sep.	21,394,000	37,770,961	37,770,961	—
10 月 Oct.	16,001,000	28,623,826	28,626,140	- 2,314
11 月 Nov.	13,361,000	16,503,115	17,778,722	- 1,275,607
12 月 Dec.	16,444,000	20,902,766	20,906,070	- 3,304

Table 2. Budget Amount, Audited Amount and Actual Collection  
in Recent Years (Cont. 8)

( II ) Revenues from Taxes

8. Amusement Tax

Unit : N.T.\$1

實 徵 數 Actual Collection			退還以前年度 歲入款 Tax Income Returned (4)	實 徵 淨 額 Net Actual Collection (1-4=5)	實徵淨額 占預算數 % Net Actual Collection /Budget Amount (5/A)×100
合 計 Total (2+3=1)	本 年 度 Current FY (2)	以 前 年 度 Previous FY (3)			
244,097,516	238,934,679	5,162,837	97,763	243,999,753	102.5
216,736,034	212,172,220	4,563,814	19,492,764	197,243,270	82.2
221,995,693	218,593,813	3,401,880	9,506,701	212,488,992	87.8
210,098,246	207,121,900	2,976,346	75,284	210,022,962	95.5
226,941,170	224,986,040	1,955,130	68,614	226,872,556	108.0
244,111,111	242,285,021	1,826,090	303,664	243,807,447	121.9
224,615,319	222,583,805	2,031,514	477,451	224,137,868	112.1
228,951,423	225,358,394	3,593,029	24,053	228,927,370	99.5
235,077,518	232,633,550	2,443,968	202,710	234,874,808	109.2
278,102,890	275,790,845	2,312,045	24,607	278,078,283	129.3
19,909,545	19,527,054	382,491	2,329	19,907,216	115.7
16,782,806	16,562,001	220,805	139	16,782,667	72.9
21,493,770	21,142,454	351,316	—	21,493,770	143.8
21,826,346	21,715,633	110,713	10,566	21,815,780	119.0
21,389,996	20,544,283	845,713	1,372	21,388,624	138.6
29,145,367	29,078,885	66,482	—	29,145,367	166.6
23,036,016	23,008,534	27,482	—	23,036,016	104.9
19,461,438	19,416,971	44,467	9,838	19,451,600	100.3
36,589,858	36,576,113	13,745	—	36,589,858	171.0
28,043,391	27,947,592	95,799	—	28,043,391	175.3
19,504,955	19,373,617	131,338	—	19,504,955	146.0
20,919,402	20,897,708	21,694	363	20,919,039	127.2

表 2 歷年各項稅捐預算數、查定數與實徵數 (續9)

## (二)稅課收入

## 9. 九年國民義務教育附徵教育經費

單位：新臺幣元

(1)小計

年度(月)別 Fiscal Year (Month)	預算數 Budget Amount (A)	查定數 Audited Amount		
		合計 Total	本年度 Current FY	以前年度 Previous FY
95 年度 FY 2006	—	21,939,547	—	21,939,547
96 年度 FY 2007	—	16,530,226	—	16,530,226
97 年度 FY 2008	—	12,539,866	—	12,539,866
98 年度 FY 2009	—	8,274,576	—	8,274,576
99 年度 FY 2010	—	4,999,750	—	4,999,750
100 年度 FY 2011	—	2,226,710	—	2,226,710
101 年度 FY 2012	—	1,200,781	—	1,200,781
102 年度 FY 2013	—	745,571	—	745,571
103 年度 FY 2014	—	424,665	—	424,665
104 年度 FY 2015	—	342,998	—	342,998
1 月 Jan.	—	342,998	—	342,998
2 月 Feb.	—	—	—	—
3 月 Mar.	—	—	—	—
4 月 Apr.	—	—	—	—
5 月 May	—	—	—	—
6 月 June	—	—	—	—
7 月 July	—	—	—	—
8 月 Aug.	—	—	—	—
9 月 Sep.	—	—	—	—
10 月 Oct.	—	—	—	—
11 月 Nov.	—	—	—	—
12 月 Dec.	—	—	—	—

Table 2. Budget Amount, Audited Amount and Actual Collection  
in Recent Years (Cont. 9)

(II) Revenues from Taxes

9. Education Surtax

(1)Subtotal

Unit : N.T.\$1

實徵數 Actual Collection			退還以前年度 歲入款 Tax Income Returned (4)	實徵淨額 Net Actual Collection (1-4=5)	實徵淨額 占預算數 % Net Actual Collection /Budge Amount (5/A)×100
合計 Total (2+3=1)	本年度 Current FY (2)	以前年度 Previous FY (3)			
1,303,967	—	1,303,967	38,877	1,265,090	--
1,386,379	—	1,386,379	12,263	1,374,116	--
755,593	—	755,593	—	755,593	--
355,000	—	355,000	1,231,783	- 876,783	--
668,897	—	668,897	10,629,176	- 9,960,279	--
344,041	—	344,041	341,047	2,994	--
304,361	—	304,361	40,452	263,909	--
73,510	—	73,510	—	73,510	--
81,667	—	81,667	38,864	42,803	--
—	—	—	1,966	- 1,966	--
—	—	—	—	—	--
—	—	—	—	—	--
—	—	—	—	—	--
—	—	—	—	—	--
—	—	—	—	—	--
—	—	—	—	—	--
—	—	—	—	—	--
—	—	—	473	-473	--
—	—	—	—	—	--
—	—	—	—	—	--
—	—	—	530	-530	--
—	—	—	—	—	--
—	—	—	963	-963	--

表 2 歷年各項稅捐預算數、查定數與實徵數 (續10)

## (二)稅課收入

## 9. 九年國民義務教育附徵教育經費

單位：新臺幣元

(2)房屋稅

年度(月)別 Fiscal Year (Month)	預算數 Budget Amount (A)	查定數 Audited Amount		
		合計 Total	本年度 Current FY	以前年度 Previous FY
95 年度 FY 2006	—	18,474,872	—	18,474,872
96 年度 FY 2007	—	13,738,671	—	13,738,671
97 年度 FY 2008	—	10,259,504	—	10,259,504
98 年度 FY 2009	—	7,692,721	—	7,692,721
99 年度 FY 2010	—	4,894,676	—	4,894,676
100 年度 FY 2011	—	2,213,603	—	2,213,603
101 年度 FY 2012	—	1,200,781	—	1,200,781
102 年度 FY 2013	—	745,571	—	745,571
103 年度 FY 2014	—	424,665	—	424,665
104 年度 FY 2015	—	342,998	—	342,998
1 月 Jan.	—	342,998	—	342,998
2 月 Feb.	—	—	—	—
3 月 Mar.	—	—	—	—
4 月 Apr.	—	—	—	—
5 月 May	—	—	—	—
6 月 June	—	—	—	—
7 月 July	—	—	—	—
8 月 Aug.	—	—	—	—
9 月 Sep.	—	—	—	—
10 月 Oct.	—	—	—	—
11 月 Nov.	—	—	—	—
12 月 Dec.	—	—	—	—

Table 2. Budget Amount, Audited Amount and Actual Collection  
in Recent Years (Cont. 10)

( II ) Revenues from Taxes

9. Education Surtax

(2) House Tax

Unit : N.T.\$1

實徵數 Actual Collection			退還以前年度 歲入款 Tax Income Returned	實徵淨額 Net Actual Collection	實徵淨額 占預算數 % Net Actual Collection /Budge Amount (5/A)×100
合計 Total (2+3=1)	本年度 Current FY (2)	以前年度 Previous FY (3)			
1,251,965	—	1,251,965	38,877	1,213,088	--
1,307,026	—	1,307,026	11,356	1,295,670	--
735,622	—	735,622	—	735,622	--
343,930	—	343,930	1,231,783	-887,853	--
664,650	—	664,650	10,629,176	- 9,964,526	--
344,041	—	344,041	341,047	2,994	--
304,361	—	304,361	40,452	263,909	--
73,510	—	73,510	—	73,510	--
81,667	—	81,667	38,864	42,803	--
—	—	—	1,966	- 1,966	--
—	—	—	—	—	--
—	—	—	—	—	--
—	—	—	—	—	--
—	—	—	—	—	--
—	—	—	—	—	--
—	—	—	—	—	--
—	—	—	—	—	--
—	—	—	—	—	--
—	—	—	473	-473	--
—	—	—	—	—	--
—	—	—	—	—	--
—	—	—	530	-530	--
—	—	—	—	—	--
—	—	—	963	-963	--

表 2 歷年各項稅捐預算數、查定數與實徵數 (續11)

## (二)稅課收入

## 9. 九年國民義務教育附徵教育經費

單位：新臺幣元

(3)娛樂稅

年度(月)別 Fiscal Year (Month)	預算數 Budget Amount (A)	查定數 Audited Amount		
		合計 Total	本年度 Current FY	以前年度 Previous FY
95 年度 FY 2006	—	3,464,675	—	3,464,675
96 年度 FY 2007	—	2,791,555	—	2,791,555
97 年度 FY 2008	—	2,280,362	—	2,280,362
98 年度 FY 2009	—	581,855	—	581,855
99 年度 FY 2010	—	105,074	—	105,074
100 年度 FY 2011	—	13,107	—	13,107
101 年度 FY 2012	—	—	—	—
102 年度 FY 2013	—	—	—	—
103 年度 FY 2014	—	—	—	—
104 年度 FY 2015	—	—	—	—
1 月 Jan.	—	—	—	—
2 月 Feb.	—	—	—	—
3 月 Mar.	—	—	—	—
4 月 Apr.	—	—	—	—
5 月 May	—	—	—	—
6 月 June	—	—	—	—
7 月 July	—	—	—	—
8 月 Aug.	—	—	—	—
9 月 Sep.	—	—	—	—
10 月 Oct.	—	—	—	—
11 月 Nov.	—	—	—	—
12 月 Dec.	—	—	—	—



表 2 歷年各項稅捐預算數、查定數與實徵數 (續12)

## (三)工程受益費

單位：新臺幣元

年度(月)別 Fiscal Year (Month)	預算數 Budget Amount (A)	查定數 Audited Amount		
		合計 Total	本年度 Current FY	以前年度 Previous FY
95 年度 FY 2006	—	45,351	—	45,351
96 年度 FY 2007	—	116,439	—	116,439
97 年度 FY 2008	—	—	—	—
98 年度 FY 2009	—	—	—	—
99 年度 FY 2010	—	—	—	—
100 年度 FY 2011	—	42,197	—	42,197
101 年度 FY 2012	—	—	—	—
102 年度 FY 2013	—	—	—	—
103 年度 FY 2014	—	—	—	—
104 年度 FY 2015	—	—	—	—
1 月 Jan.	—	—	—	—
2 月 Feb.	—	—	—	—
3 月 Mar.	—	—	—	—
4 月 Apr.	—	—	—	—
5 月 May	—	—	—	—
6 月 June	—	—	—	—
7 月 July	—	—	—	—
8 月 Aug.	—	—	—	—
9 月 Sep.	—	—	—	—
10 月 Oct.	—	—	—	—
11 月 Nov.	—	—	—	—
12 月 Dec.	—	—	—	—



表 2 歷年各項稅捐預算數、查定數與實徵數 (續13)

## (四)罰鍰收入

單位：新臺幣元

年度(月)別 Fiscal Year (Month)	預算數 Budget Amount (A)	查定數 Audited Amount		
		合計 Total	本年度 Current FY	以前年度 Previous FY
95 年度 FY 2006	183,000,000	437,452,233	72,706,354	364,745,879
96 年度 FY 2007	183,000,000	442,108,236	126,466,198	315,642,038
97 年度 FY 2008	204,000,000	475,339,022	162,206,174	313,132,848
98 年度 FY 2009	201,000,000	494,714,768	157,439,459	337,275,309
99 年度 FY 2010	155,000,000	547,722,155	204,193,586	343,528,569
100 年度 FY 2011	154,000,000	563,414,313	133,481,505	429,932,808
101 年度 FY 2012	135,000,000	496,099,434	98,656,201	397,443,233
102 年度 FY 2013	131,000,000	493,644,600	101,500,747	392,143,853
103 年度 FY 2014	104,000,000	428,292,564	74,173,335	354,119,229
104 年度 FY 2015	114,000,000	356,237,931	61,313,858	294,924,073
1 月 Jan.	9,292,000	327,076,592	168,137	326,908,455
2 月 Feb.	5,268,000	3,574,746	367,659	3,207,087
3 月 Mar.	9,139,000	4,895,156	2,710,609	2,184,547
4 月 Apr.	7,068,000	9,713,074	8,233,889	1,479,185
5 月 May	11,110,000	7,093,920	4,159,976	2,933,944
6 月 June	9,816,000	10,680,978	6,332,977	4,348,001
7 月 July	8,883,000	7,491,126	4,444,275	3,046,851
8 月 Aug.	9,853,000	3,686,056	2,932,866	753,190
9 月 Sep.	5,167,000	7,907,640	6,979,899	927,741
10 月 Oct.	6,669,000	7,530,965	5,033,031	2,497,934
11 月 Nov.	9,984,000	-46,957,567	7,633,861	- 54,591,428
12 月 Dec.	21,751,000	13,545,245	12,316,679	1,228,566

Table 2. Budget Amount, Audited Amount and Actual Collection  
in Recent Years (Cont. 13)

(IV) Punitive Fine Revenue

Unit : N.T.\$1

實徵數 Actual Collection			退還以前年度 歲入款 Tax Income Returned (4)	實徵淨額 Net Actual Collection (1-4=5)	實徵淨額 占預算數 % Net Actual Collection /Budge Amount (5/A)×100
合計 Total (2+3=1)	本年度 Current FY (2)	以前年度 Previous FY (3)			
230,087,703	53,836,140	176,251,563	4,777,848	225,309,855	123.1
191,975,376	58,776,047	133,199,329	6,943,632	185,031,744	101.1
191,887,419	64,189,183	127,698,236	8,921,665	182,965,754	89.7
199,652,733	58,490,467	141,162,266	47,262,251	152,390,482	75.8
165,963,949	62,178,322	103,785,627	105,644,011	60,319,938	38.9
188,127,746	59,663,707	128,464,039	27,995,613	160,132,133	104.0
130,740,906	43,159,508	87,581,398	12,973,313	117,767,593	87.2
143,182,097	55,284,547	87,897,550	13,370,440	129,811,657	99.1
105,643,689	41,076,486	64,567,203	3,757,801	101,885,888	98.0
101,262,895	42,028,868	59,234,027	6,209,105	95,053,790	83.4
7,018,906	119,872	6,899,034	1,115,823	5,903,083	63.5
5,416,528	329,833	5,086,695	838,937	4,577,591	86.9
6,476,004	1,764,567	4,711,437	399,992	6,076,012	66.5
9,300,911	5,019,417	4,281,494	224,897	9,076,014	128.4
10,202,854	5,038,317	5,164,537	513,967	9,688,887	87.2
10,928,548	4,434,965	6,493,583	440,080	10,488,468	106.9
8,913,137	3,230,140	5,682,997	580,900	8,332,237	93.8
6,151,672	2,575,452	3,576,220	1,014,902	5,136,770	52.1
8,617,575	4,260,630	4,356,945	128,249	8,489,326	164.3
7,793,342	2,860,443	4,932,899	287,674	7,505,668	112.5
8,432,916	4,400,556	4,032,360	276,587	8,156,329	81.7
12,010,502	7,994,676	4,015,826	387,097	11,623,405	53.4

表 2 歷年各項稅捐預算數、查定數與實徵數 (續14完)

## (五)規費收入

單位：新臺幣元

監證費

年度(月)別 Fiscal Year (Month)	預算數 Budget Amount (A)	查定數 Audited Amount		
		合計 Total	本年度 Current FY	以前年度 Previous FY
95 年度 FY 2006	—	—	—	—
96 年度 FY 2007	—	4,097	—	4,097
97 年度 FY 2008	—	—	—	—
98 年度 FY 2009	—	149,080	—	149,080
99 年度 FY 2010	—	—	—	—
100 年度 FY 2011	—	—	—	—
101 年度 FY 2012	—	—	—	—
102 年度 FY 2013	—	—	—	—
103 年度 FY 2014	—	—	—	—
104 年度 FY 2015	—	—	—	—
1 月 Jan.	—	—	—	—
2 月 Feb.	—	—	—	—
3 月 Mar.	—	—	—	—
4 月 Apr.	—	—	—	—
5 月 May	—	—	—	—
6 月 June	—	—	—	—
7 月 July	—	—	—	—
8 月 Aug.	—	—	—	—
9 月 Sep.	—	—	—	—
10 月 Oct.	—	—	—	—
11 月 Nov.	—	—	—	—
12 月 Dec.	—	—	—	—



表 3 各項稅捐納庫數

## (一)歷年別

單位：新臺幣元

年 度 (月) 別 Fiscal Year (Month)	實 徵 數 ① Actual Collection	納 庫 數	
		合 計 Total	國 庫 Nation Treasury
95 年 度 FY 2006 ③	59,935,082,828	59,934,140,690	—
96 年 度 FY 2007 ④	62,211,212,658	62,211,212,658	—
97 年 度 FY 2008 ⑤	57,349,343,608	57,349,343,608	—
98 年 度 FY 2009	57,906,303,509	57,906,010,169	—
99 年 度 FY 2010 ⑥	61,412,898,686	61,412,898,686	—
100 年 度 FY 2011	62,364,742,945	62,364,742,945	—
101 年 度 FY 2012 ⑦	62,751,393,789	62,751,393,789	—
102 年 度 FY 2013 ⑧	66,673,882,137	66,673,882,137	—
103 年 度 FY 2014	67,721,827,234	67,721,827,234	—
104 年 度 FY 2015 ⑨	77,243,428,036	77,243,428,036	—
1 月 Jan.	3,219,307,968	2,497,153,278	—
2 月 Feb.	1,717,171,179	2,187,096,241	—
3 月 Mar.	3,013,293,286	2,744,475,483	—
4 月 Apr.	5,395,743,543	4,179,877,728	—
5 月 May	11,830,853,317	9,697,649,880	—
6 月 June	7,913,959,641	11,400,443,543	—
7 月 July	3,435,732,067	2,699,318,677	—
8 月 Aug.	2,350,545,808	2,994,430,395	—
9 月 Sep.	2,487,929,249	2,656,829,553	—
10 月 Oct.	2,730,286,286	2,468,095,882	—
11 月 Nov.	14,571,792,796	9,682,828,186	—
12 月 Dec.	18,576,812,896	24,035,229,190	—

資料來源：依據徵課會計報告編製。

附 註：①自99年度起實徵數未含實物抵繳稅款(以遞延收入入帳)。

②年度之未納庫數係歷年實物抵繳稅款累計數。

③以前年度實物抵繳23,648元於95年度變賣納庫。

④以前年度實物抵繳26,763元於96年度變賣納庫。

Table 3. Taxation Forwarded to Treasury

## ( I ) Fiscal Year

Unit : N.T.\$1

Pay to Treasury			未納庫數 Unpay to ② Treasury
中央統籌專戶 Distribution of Central Gov't	重建基金庫 Reconstruction Fund	市庫 The Municipal Treasury	
—	—	59,934,140,690	58,914,091
—	—	62,211,212,658	58,887,328
—	—	57,349,343,608	58,886,859
—	—	57,906,010,169	59,180,199
—	—	61,412,898,686	59,145,876
—	—	62,364,742,945	59,145,876
—	—	62,751,393,789	59,489,460
—	—	66,673,882,137	59,451,157
—	—	67,721,827,234	59,451,157
—	—	77,243,428,036	59,396,611
—	—	2,497,153,278	722,154,690
—	—	2,187,096,241	252,229,628
—	—	2,744,475,483	521,047,431
—	—	4,179,877,728	1,736,913,246
—	—	9,697,649,880	3,870,116,683
—	—	11,400,443,543	383,632,781
—	—	2,699,318,677	1,120,046,171
—	—	2,994,430,395	476,161,584
—	—	2,656,829,553	307,261,280
—	—	2,468,095,882	569,451,684
—	—	9,682,828,186	5,458,416,294
—	—	24,035,229,190	—

⑤ 以前年度實物抵繳469元於97年度變賣納庫。

⑥ 以前年度實物抵繳34,323元於99年度變賣納庫。

⑦ 101年度未納庫數含實物抵繳343,584元。

⑧ 以前年度實物抵繳38,303元於102年度變賣納庫。

⑨ 以前年度實物抵繳54,546元於104年度變賣納庫。

表 3 各項稅捐納庫數(續)

(二)稅目別  
104年度

單位：新臺幣元

稅目別 Item of Tax	實徵數 Actual Collection	納庫數 Pay to Treasury			
		合計 Total	國庫 The Nation Treasury	中央統籌專戶 Distribution of Central Gov't	重建基金庫 Reconstruction Fund
<b>總計</b> <b>Grand Total</b>	77,243,428,036	77,243,428,036	—	—	—
地價稅 Land Value Tax	22,089,792,483	22,089,792,483	—	—	—
土地增值稅 Land value Increment Tax	26,011,486,168	26,011,486,168	—	—	—
房屋稅 House Tax	14,203,137,405	14,203,137,405	—	—	—
使用牌照稅 Vehicle License Tax	7,403,407,388	7,403,407,388	—	—	—
契稅 Deed Tax	2,619,757,703	2,619,757,703	—	—	—
印花稅 Stamp Tax	4,536,481,104	4,536,481,104	—	—	—
娛樂稅 Amusement Tax	278,102,890	278,102,890	—	—	—
教育經費 Education Surtax	—	—	—	—	—
工程受益費 Construction Benefit Fee	—	—	—	—	—
罰鍰收入 Punitive Fine Revenue	101,262,895	101,262,895	—	—	—
規費收入 Fees Revenue	—	—	—	—	—

Table 3. Taxation Forwarded to Treasury (Cont.)

( II ) Item of Tax				
FY 2015				
Unit : N.T.\$1				
退還以前年度歲入款 Tax Income Returned				
市 庫 The Municipal Treasury	合 計 Total	國 庫 The Nation Treasury	中央統籌專戶 Distribution of Central Gov't	市 庫 The Municipal Treasury
77,243,428,036	325,010,445	—	—	325,010,445
22,089,792,483	49,642,280	—	—	49,642,280
26,011,486,168	243,621,242	—	—	243,621,242
14,203,137,405	8,028,056	—	—	8,028,056
7,403,407,388	3,706,191	—	—	3,706,191
2,619,757,703	6,636,420	—	—	6,636,420
4,536,481,104	7,140,578	—	—	7,140,578
278,102,890	24,607	—	—	24,607
—	1,966	—	—	1,966
—	—	—	—	—
101,262,895	6,209,105	—	—	6,209,105
—	—	—	—	—

表 4 歷年各項稅捐實徵淨額及指數

基 比：100年度=100

環 比：上年度=100

分 配 比：各年度總計=100

單位：新臺幣千元

稅 目 別 Item of Tax	95年度 FY2006	96年度 FY2007			97年度	
	實徵淨額 Net Actual Collection	實徵淨額 Net Actual Collection	指數 Index		分配比 Shares	實徵淨額 Net Actual Collection
			基 比 Fixed Index	環 比 Link Index		
<b>總 計</b> <b>Grand Total</b>	<b>59,559,142</b>	<b>61,880,951</b>	<b>99.6</b>	<b>103.9</b>	<b>100.0</b>	<b>56,753,478</b>
稅 課 收 入 Revenues from Taxes	59,333,787	61,695,799	99.5	104.0	99.7	56,570,534
地 價 稅 Land Value Tax	17,900,813	19,468,697	94.9	108.8	31.5	19,188,394
土地增值稅 Land Value Increment Tax	18,608,089	19,037,783	109.4	102.3	30.8	13,549,409
房 屋 稅 House Tax	9,997,706	10,091,271	92.9	100.9	16.3	10,140,620
使用牌照稅 Vehicle License Tax	6,442,749	6,562,146	97.6	101.9	10.6	6,536,438
契 稅 Deed Tax	2,389,860	2,468,967	123.2	103.3	4.0	2,369,087
印 花 稅 Stamp Tax	3,749,305	3,868,318	91.1	103.2	6.2	4,573,341
娛 樂 稅 Amusement Tax	244,000	197,243	80.9	80.8	0.3	212,489
教育經費 Education Surtax	1,265	1,374	45,800.0	108.6	0.0	756
工程受益費 Construction Benefit Fee	45	116	276.2	257.8	0.0	- 22
罰 鍰 收 入 Punitive Fine Revenue	225,310	185,032	115.5	82.1	0.3	182,966
規 費 收 入 Fees Revenue	—	4	--	--	0.0	—
契稅監證費 Fees	—	4	--	--	0.0	—

資料來源：依據徵課會計報告編製。

Table 4. Net Amount Remitted and Index in Recent Years

Fixed Index:FY2011=100

Link Index:Last Year=100

Shares:Total=100

Unit:N.T.\$1,000

FY 2008			98年度 FY2009				99年度 FY2010				
指數 Index		分配比 Shares	實徵淨額 Net Actual Collection	指數 Index		分配比 Shares	實徵淨額 Net Actual Collection	指數 Index		分配比 Shares	
基 比 Fixed Index	環 比 Link Index			基 比 Fixed Index	環 比 Link Index			基 比 Fixed Index	環 比 Link Index		
91.3	91.7	100.0	57,498,023	92.5	101.3	100.0	60,905,235	98.0	105.9	100.0	
91.2	91.7	99.7	57,345,484	92.5	101.4	99.7	60,844,915	98.1	106.1	99.9	
93.6	98.6	33.8	18,702,394	91.2	97.5	32.5	20,291,042	99.0	108.5	33.3	
77.8	71.2	23.9	15,413,916	88.5	113.8	26.8	16,884,890	97.0	109.5	27.7	
93.3	100.5	17.9	10,295,486	94.8	101.5	17.9	10,500,537	96.6	102.0	17.3	
97.2	99.6	11.5	6,462,009	96.1	98.9	11.2	6,542,070	97.3	101.2	10.7	
118.2	96.0	4.2	2,357,002	117.6	99.5	4.1	2,327,147	116.1	98.7	3.8	
107.7	118.2	8.0	3,905,531	92.0	85.4	6.8	4,082,316	96.1	104.5	6.7	
87.2	107.7	0.4	210,023	86.1	98.8	0.4	226,873	93.1	108.0	0.4	
25,200.0	55.0	0.0	- 877	--	--	- 0.0	- 9,960	--	--	- 0.0	
--	--	- 0.0	--	--	--	--	--	--	--	--	
114.3	98.9	0.3	152,390	95.2	83.3	0.3	60,320	37.7	39.6	0.1	
--	--	--	149	--	--	0.0	--	--	--	--	
--	--	--	149	--	--	0.0	--	--	--	--	





表 5 本處各項稅捐稽徵成本①②

Table 5. Cost of Tax Levying ①②

年度及稅目別 Fiscal Year & Item of Tax	實徵淨額 (千元) Net Actual Collection (N.T.\$1000) (1)	實支經費 (元) Expense (N.T.\$1) (2)	每千元成本 (元) Cost of \$1,000 (2)/(1)
95 年度 FY 2006	59,333,787	914,484,276	15.4125
96 年度 FY 2007	61,695,799	898,794,972	14.5682
97 年度 FY 2008	56,570,534	894,798,178	15.8174
98 年度 FY 2009	57,345,484	894,489,263	15.5983
99 年度 FY 2010	60,844,915	899,839,885	14.7891
100 年度 FY 2011	61,999,268	888,513,303	14.3310
101 年度 FY 2012	62,189,138	893,122,419	14.3614
102 年度 FY 2013	66,310,719	904,340,532	13.6379
103 年度 FY 2014	67,291,124	915,806,028	13.6096
104 年度 FY 2015	76,823,364	915,744,460	11.9201
地價稅 Land Value Tax	22,040,150	267,424,014	12.1335
土地增值稅 Land Value Increment Tax	25,767,865	198,764,793	7.7137
房屋稅 House Tax	14,195,108	236,107,374	16.6330
使用牌照稅 Vehicle License Tax	7,399,701	113,488,579	15.3369
契稅 Deed Tax	2,613,121	41,268,574	15.7928
印花稅 Stamp Tax	4,529,341	33,051,380	7.2972
娛樂稅 Amusement Tax	278,078	25,639,746	92.2034

資料來源：根據本處會計室資料編製。

附註：①依據財政部賦稅署擬訂之各稅稽徵成本計算方式一致性規定說明書之編算原則核計。

②房屋稅與娛樂稅實徵淨額含九年國民義務教育附徵教育經費。

## 參、稅源及其他

### III . Tax Sources and Others

表 6 地價稅稅源

單位 { 面積：公頃  
金額：新臺幣千元

年別及稅地種類別		戶數	筆數
Year & Classification		No. of House	Plots
99	年 2010	843,247	1,814,594
100	年 2011	852,009	1,843,386
101	年 2012	860,251	1,868,226
102	年 2013	867,911	1,917,506
103	年 2014	875,372	1,941,736
104	年 2015	881,734	1,960,793
公	有 Public	460	136,117
一般土地	Regular Land	441	122,735
自用住宅用地	Self-use Residence Land	8	166
工礦業等用地	Specific Business Land	—	161
公共設施保留地	Land Reserved for Public Facilities	11	13,055
私	有 Private	881,274	1,824,676
一般土地	Regular Land	380,292	828,020
第一級	Level 1	376,684	787,069
第二級	Level 2	3,094	27,933
第三級	Level 3	260	2,617
第四級	Level 4	96	1,282
第五級	Level 5	40	719
第六級	Level 6	118	8,400
自用住宅用地	Self-use Residence Land	498,309	921,445
都市土地	Urban Land	498,309	921,445
非都市土地	Non-Urban Land	—	—
工礦業等用地	Specific Business Land	26	1,428
公共設施保留地	Land Reserved for Public Facilities	2,647	73,783

資料來源：根據本處財產稅科資料編製。

Table 6. Sources of Land Value Tax

Unit: { Area : Hectare Amount : N.T.\$1,000		
課 稅 面 積 Taxed Area	課 稅 地 價 Taxed Land Value	地 價 稅 額 Land Value Tax
4,959.2458	2,091,696,127	20,056,339
4,915.9018	2,087,899,910	20,131,896
5,034.7634	2,096,510,787	20,339,436
4,951.7003	2,247,409,509	22,164,453
4,971.4676	2,253,998,074	22,260,505
4,952.6736	2,242,518,610	22,048,902
311.4796	171,807,887	1,658,740
286.2580	163,287,589	1,632,876
20.5039	6,438,076	12,876
0.2054	123,653	1,237
4.5122	1,958,569	11,751
4,641.1939	2,070,710,723	20,390,162
2,374.1071	1,054,953,421	18,020,412
1,544.7136	639,518,802	6,395,177
391.6221	158,741,117	1,983,013
78.9507	39,864,277	662,000
50.1681	30,166,473	654,095
29.9553	18,927,055	497,944
278.6971	167,735,696	7,828,184
2,087.8520	964,856,237	1,929,683
2,087.8520	964,856,237	1,929,683
—	—	—
75.9297	33,665,412	336,654
103.3050	17,235,652	103,413

表 7 土地增值稅稅源

單位 { 面積：公頃  
金額：新臺幣千元

年度及稅率別 Fiscal Year & Rate of Tax	筆數 Plots	面積 Area	移轉現值 Present Value of Transfer	調整後原地價 Originally Declared Value After Adjustment	
95 年 度 FY2006	137,910	610.5693	452,335,486	311,509,340	
96 年 度 FY2007	133,614	598.8314	449,354,075	309,302,178	
97 年 度 FY2008	134,635	513.1119	418,194,495	299,218,322	
98 年 度 FY2009	124,589	415.3626	411,747,421	286,607,620	
99 年 度 FY2010	138,294	509.0032	440,310,323	305,753,138	
100 年 度 FY2011	127,170	436.1678	382,853,776	252,580,246	
101 年 度 FY2012	102,169	334.1813	321,992,197	193,999,469	
102 年 度 FY2013	105,050	324.0251	353,553,228	200,038,953	
103 年 度 FY2014	96,178	301.5794	325,747,728	167,132,088	
104 年 度 FY2015	88,557	286.3694	387,856,294	203,230,575	
自用住宅用地 稅率10%	Self-use Residence Land (Rate 10%)	9,934	21.2711	55,487,410	22,153,624
一般用地	Regular Land	53,716	120.1753	233,303,679	131,290,229
稅率20%	Rate 20%	40,730	83.9924	165,940,977	114,250,490
稅率30%	Rate 30%	5,684	12.6798	28,643,982	12,262,623
稅率40%	Rate 40%	7,246	23.5031	38,718,720	4,777,116
其他	Others	56	—	—	—
免稅地	Exempt Land	24,907	144.9230	99,065,205	49,786,722
公有土地	Public Land	411	2.7026	15,222,790	669,645
私有土地	Private Land	24,496	142.2204	83,842,416	49,117,077

資料來源：根據本處財產稅科資料編製。

附註：①102年度起含免稅地相關資料。

Table 7. Sources of Land Value Increment Tax

 Unit: { Area : Hectare  
 Amount : N.T.\$1,000

改良土地費用 Land Improvement Cost	漲價總數額 Cross Amount of Land Value Increment	查定稅額① Assessment Tax	增繳地價稅① Supplemental Payment of Land Value Tax	減徵稅額① Reduction	應納稅額 Tax Payable
4,241,536	136,584,610	20,497,584	908,315	1,319,686	18,269,583
2,264,726	137,787,171	22,179,717	946,091	1,002,950	20,230,676
1,266,847	117,709,326	16,157,946	611,854	428,479	15,117,613
2,003,969	123,135,832	17,240,793	684,454	709,141	15,847,198
1,429,814	133,127,371	19,232,065	773,734	861,337	17,596,994
659,623	129,613,907	18,695,238	727,894	646,878	17,320,466
261,858	127,730,870	17,406,309	705,764	550,475	16,150,070
335,014	157,067,733	38,289,539	817,989	441,657	20,368,311
1,607,913	159,997,437	38,641,701	949,642	1,379,617	20,962,675
345,072	186,858,703	43,430,844	1,086,187	5,124,784	25,848,413
3,561	33,330,226	3,332,580	150,321	50,208	3,139,122
323,833	101,689,616	24,420,587	845,135	2,450,594	22,709,291
5,605	51,684,882	10,336,961	264,037	95,854	9,964,967
21,984	16,359,374	3,673,004	161,503	138,531	3,376,443
296,245	33,645,360	10,409,071	419,574	2,216,210	9,366,351
—	—	1,552	22	—	1,530
17,678	51,838,861	15,677,677	90,731	2,623,982	—
835	14,555,636	4,628,774	8,588	1,049,648	—
16,843	37,283,224	11,048,902	82,143	1,574,334	—

表 8 房 屋 稅 稅 源

單位 { 面積：平方公尺  
金額：新臺幣千元

年度別、構造及使用別 Fiscal Year & Structure & Use	合計 Total		
	戶數 Number of House	面積 Area	現值 Value
<b>100 年 度 FY2011</b>	<b>1,089,541</b>	<b>178,554,255</b>	<b>753,492,124</b>
<b>101 年 度 FY2012</b>	<b>1,097,581</b>	<b>180,692,750</b>	<b>832,912,306</b>
<b>102 年 度 FY2013</b>	<b>1,105,979</b>	<b>184,555,387</b>	<b>846,250,956</b>
<b>103 年 度 FY2014</b>	<b>1,112,554</b>	<b>187,129,628</b>	<b>860,003,225</b>
<b>104 年 度 FY2015</b>	<b>1,144,671</b>	<b>194,102,485</b>	<b>967,614,468</b>
<b>住 家 用 Residence</b>	<b>796,856</b>	<b>84,756,537</b>	<b>364,773,619</b>
<b>營 業 用 Business</b>	<b>150,954</b>	<b>34,864,793</b>	<b>286,759,954</b>
<b>非住家非營業用 Non-Residence、Non-Business</b>	<b>48,288</b>	<b>15,652,560</b>	<b>88,654,333</b>
<b>全部免稅及部份免稅 Exempt House</b>	<b>148,573</b>	<b>58,828,595</b>	<b>227,426,561</b>
<b>鋼 骨 混 凝 土 造 Steeled Concrete</b>	<b>33,962</b>	<b>24,366,815</b>	<b>314,092,202</b>
住 家 用 Residence	16,861	2,998,739	68,589,750
營 業 用 Business	10,079	8,877,097	145,580,124
非住家非營業用 Non-Residence、Non-Business	4,968	4,138,402	34,919,336
全部免稅及部份免稅 Exempt House	2,054	8,352,578	65,002,993
<b>鋼 筋 混 凝 土 及 預 鑄 造 Concrete&amp;Reinforced Prefabricated</b>	<b>956,807</b>	<b>152,195,722</b>	<b>632,503,824</b>
住 家 用 Residence	720,633	73,821,535	285,977,075
營 業 用 Business	117,766	22,907,296	136,917,731
非住家非營業用 Non-Residence、Non-Business	40,960	11,083,251	53,156,373
全部免稅及部份免稅 Exempt House	77,448	44,383,640	156,452,645
<b>鋼 筋 混 凝 土 加 強 磚 造 Ferroconcrete Brick</b>	<b>107,136</b>	<b>12,874,947</b>	<b>16,442,202</b>
住 家 用 Residence	50,914	6,752,743	8,791,957
營 業 用 Business	15,773	2,093,569	3,102,816
非住家非營業用 Non-Residence、Non-Business	1,582	288,875	405,508
全部免稅及部份免稅 Exempt House	38,867	3,739,760	4,141,921
<b>鋼 鐵 造 Metal</b>	<b>7,269</b>	<b>1,469,182</b>	<b>1,933,610</b>
住 家 用 Residence	2,899	436,526	587,562
營 業 用 Business	2,007	568,304	757,346
非住家非營業用 Non-Residence、Non-Business	327	81,791	112,543
全部免稅及部份免稅 Exempt House	2,036	382,562	476,160

資料來源：根據本處財產稅科資料編製。

Table 8. Sources of House Tax

Unit:  $\left\{ \begin{array}{l} \text{Area : m}^2 \\ \text{Amount : N.T. \$1,000} \end{array} \right.$ 

公有 Public			私有 Private		
戶數 Number of House	面積 Area	現值 Value	戶數 Number of House	面積 Area	現值 Value
25,223	23,243,844	92,350,866	1,064,318	155,310,411	661,141,259
25,604	23,768,422	101,179,846	1,071,977	156,924,328	731,732,460
25,082	24,155,256	102,135,487	1,080,897	160,400,131	744,115,469
22,095	24,565,303	103,075,967	1,090,459	162,564,325	756,927,258
23,165	25,083,249	104,999,438	1,121,506	169,019,236	862,615,030
3,478	381,090	1,475,833	793,378	84,375,447	363,297,786
1,242	1,334,748	8,912,617	149,712	33,530,045	277,847,337
501	1,778,823	5,867,409	47,787	13,873,737	82,786,924
17,944	21,588,588	88,743,579	130,629	37,240,007	138,682,982
609	4,216,034	31,548,225	33,353	20,150,781	282,543,976
19	4,865	32,141	16,842	2,993,873	68,557,608
165	349,143	3,278,155	9,914	8,527,953	142,301,969
75	348,280	1,591,371	4,893	3,790,122	33,327,965
350	3,513,745	26,646,558	1,704	4,838,832	38,356,435
15,343	19,500,456	71,771,383	941,464	132,695,265	560,732,441
3,403	365,881	1,428,814	717,230	73,455,653	284,548,261
876	939,188	5,561,530	116,890	21,968,108	131,356,202
394	1,422,058	4,266,428	40,566	9,661,193	48,889,945
10,670	16,773,329	60,514,612	66,778	27,610,310	95,938,033
2,202	698,154	992,333	104,934	12,176,793	15,449,869
30	5,882	8,806	50,884	6,746,861	8,783,150
87	31,034	56,566	15,686	2,062,536	3,046,251
22	4,300	5,140	1,560	284,575	400,368
2,063	656,938	921,821	36,804	3,082,821	3,220,100
202	130,823	246,165	7,067	1,338,360	1,687,445
1	213	288	2,898	436,313	587,273
17	3,223	3,628	1,990	565,081	753,718
1	630	817	326	81,161	111,725
183	126,757	241,432	1,853	255,806	234,728

表 8 房屋稅稅源 (續)

單位 { 面積：平方公尺  
金額：新臺幣千元

年度別、構造及使用別 Fiscal Year & Structure & Use	合計 Total		
	戶數 Number of House	面積 Area	現值 Value
<b>磚石造 Brick</b>	<b>28,450</b>	<b>2,483,329</b>	<b>2,242,573</b>
住家用 Residence	5,167	694,501	777,703
營業用 Business	4,033	332,542	340,400
非住家非營業用 Non-Residence、Non-Business	365	51,597	54,882
全部免稅及部份免稅 Exempt House	18,885	1,404,689	1,069,588
<b>啫咕石造 Lo-Ko Stone</b>	<b>438</b>	<b>25,667</b>	<b>15,627</b>
住家用 Residence	25	2,430	2,153
營業用 Business	74	3,199	2,482
非住家非營業用 Non-Residence、Non-Business	7	756	513
全部免稅及部份免稅 Exempt House	332	19,282	10,479
<b>卵石混凝土造 Concrete &amp; Pebble</b>	<b>41</b>	<b>4,052</b>	<b>3,243</b>
住家用 Residence	9	1,615	1,538
營業用 Business	2	227	127
非住家非營業用 Non-Residence、Non-Business	1	139	150
全部免稅及部份免稅 Exempt House	29	2,072	1,429
<b>木造 Wood</b>	<b>9,031</b>	<b>580,923</b>	<b>374,598</b>
住家用 Residence	340	47,151	44,815
營業用 Business	1,200	78,678	58,432
非住家非營業用 Non-Residence、Non-Business	78	7,749	5,029
全部免稅及部份免稅 Exempt House	7,413	447,345	266,322
<b>土磚造 Earthen Brick</b>	<b>1,341</b>	<b>92,666</b>	<b>5,899</b>
住家用 Residence	8	1,297	1,068
營業用 Business	11	1,368	194
非住家非營業用 Non-Residence、Non-Business	—	—	—
全部免稅及部份免稅 Exempt House	1,322	90,001	4,638
<b>竹造 Bamboo</b>	<b>196</b>	<b>9,181</b>	<b>691</b>
住家用 Residence	—	—	—
營業用 Business	9	2,513	303
非住家非營業用 Non-Residence、Non-Business	—	—	—
全部免稅及部份免稅 Exempt House	187	6,668	387

Table 8. Sources of House Tax (Cont.)

 Unit:  $\begin{cases} \text{Area : m}^2 \\ \text{Amount : N.T. \$1,000} \end{cases}$ 

公有 Public			私有 Private		
戶數 Number of House	面積 Area	現值 Value	戶數 Number of House	面積 Area	現值 Value
<b>2,385</b>	<b>341,829</b>	<b>319,464</b>	<b>26,065</b>	<b>2,141,501</b>	<b>1,923,110</b>
24	4,123	5,608	5,143	690,378	772,095
56	8,518	10,426	3,977	324,024	329,974
5	3,280	3,423	360	48,317	51,459
2,300	325,908	300,006	16,585	1,078,781	769,582
<b>24</b>	<b>1,328</b>	<b>776</b>	<b>414</b>	<b>24,339</b>	<b>14,852</b>
—	—	—	25	2,430	2,153
—	—	—	74	3,199	2,482
—	—	—	7	756	513
24	1,328	776	308	17,953	9,704
<b>1</b>	<b>136</b>	<b>58</b>	<b>40</b>	<b>3,916</b>	<b>3,186</b>
—	—	—	9	1,615	1,538
—	—	—	2	227	127
—	—	—	1	139	150
1	136	58	28	1,936	1,371
<b>2,380</b>	<b>193,659</b>	<b>121,006</b>	<b>6,651</b>	<b>387,264</b>	<b>253,592</b>
1	125	175	339	47,026	44,640
41	3,642	2,314	1,159	75,036	56,118
4	275	230	74	7,474	4,799
2,334	189,617	118,287	5,079	257,728	148,035
<b>14</b>	<b>595</b>	<b>19</b>	<b>1,327</b>	<b>92,071</b>	<b>5,880</b>
—	—	—	8	1,297	1,068
—	—	—	11	1,368	194
—	—	—	—	—	—
14	595	19	1,308	89,406	4,618
<b>5</b>	<b>235</b>	<b>9</b>	<b>191</b>	<b>8,946</b>	<b>681</b>
—	—	—	—	—	—
—	—	—	9	2,513	303
—	—	—	—	—	—
5	235	9	182	6,433	378

表 9 使用牌照稅稅源 ① ②

單位：件數

年 度 (月) 別 Fiscal Year (Month)			合 計 Grand Total		小客車③ Sedan	
			應 稅 Taxable	免 稅 Exempt	應 稅 Taxable	免 稅 Exempt
95	年 度	FY2006	735,342	17,237	642,890	16,577
96	年 度	FY2007	742,355	16,855	650,569	16,391
97	年 度	FY2008	746,054	16,177	644,206	15,696
98	年 度	FY2009	740,831	17,330	638,594	16,937
99	年 度	FY2010	760,699	17,301	654,886	16,779
100	年 度	FY2011	785,192	14,007	675,588	13,311
101	年 度	FY2012	807,716	17,117	693,474	16,256
102	年 度	FY2013	830,876	17,321	711,151	16,698
103	年 度	FY2014	879,372	16,690	746,060	15,827
104	年 度	FY2015	917,529	16,843	777,147	16,216
1	月	Jan.	21,032	1,499	18,332	1,442
2	月	Feb.	16,269	990	14,241	981
3	月	Mar.	50,357	1,743	42,857	1,725
4	月	Apr.	367,233	1,760	315,575	1,721
5	月	May	276,409	1,477	240,115	1,439
6	月	June	11,142	1,234	9,721	1,223
7	月	July	17,002	1,675	14,323	1,660
8	月	Aug.	16,196	1,134	13,630	1,121
9	月	Sep.	12,437	1,068	10,070	1,045
10	月	Oct.	30,664	1,461	21,268	1,227
11	月	Nov.	91,254	1,300	70,630	1,208
12	月	Dec.	7,534	1,502	6,385	1,424

資料來源：根據本處機會稅科資料編製。

附 註：①本表臨時牌照、試車牌照及外賓車輛不予計列。

附 註：②102年以前件數為本年度實徵件數，103年起件數為本年度實徵件數+以前年度實徵件數。

③小客車、大客車、貨車中均分為自用與營業用，自用全年開徵1次。營業用分兩期開徵，表列數字均依照年度結束累計數填列。

Table 9. Sources of Vehicle License Tax ① ②

Unit : Case

大客車③ Bus		貨車③ Truck		機器腳踏車 Motorcycle	
應 稅 Taxable	免 稅 Exempt	應 稅 Taxable	免 稅 Exempt	應 稅 Taxable	免 稅 Exempt
6,418	398	80,153	246	5,881	16
6,639	216	84,277	241	870	7
6,582	257	87,197	220	8,069	4
6,682	213	86,878	168	8,677	12
7,535	318	88,809	171	9,469	33
7,961	520	90,583	154	11,060	22
8,237	643	92,732	197	13,273	21
8,485	423	93,267	164	17,973	36
9,161	528	100,464	311	23,687	24
9,871	155	101,822	437	28,689	35
245	5	1,670	49	785	3
208	4	1,215	5	605	—
232	1	3,967	8	3,301	9
2,822	28	36,529	5	12,307	6
1,467	33	28,708	3	6,119	2
137	6	427	3	857	2
193	6	1,364	3	1,122	6
133	10	1,480	3	953	—
271	11	1,279	12	817	—
2,244	16	6,500	215	652	3
1,786	4	18,256	87	582	1
133	31	427	44	589	3

表 10 契 稅 稅 源

金額單位：新臺幣千元

年 度 (月) 別 Fiscal Year (Month)			合 計 Total		買 賣 契 Sale		典 權 契 Mortgage	
			件 數 Cases	契 價 Deed Value	件 數 Cases	契 價 Deed Value	件 數 Cases	契 價 Deed Value
95	年 度	FY2006	79,012	41,555,453	71,997	38,820,971	—	—
96	年 度	FY2007	73,683	41,980,833	65,634	38,907,839	—	—
97	年 度	FY2008	75,310	41,816,490	67,242	38,369,514	—	—
98	年 度	FY2009	74,931	41,053,558	66,802	38,260,775	1	486
99	年 度	FY2010	75,298	40,464,169	66,392	37,287,407	1	0
100	年 度	FY2011	61,336	35,197,097	51,816	31,575,261	1	133
101	年 度	FY2012	51,933	31,062,867	41,217	27,193,643	—	—
102	年 度	FY2013	51,550	29,279,464	41,398	25,134,588	1	513
103	年 度	FY2014	43,604	29,226,966	32,877	25,239,643	—	—
104	年 度	FY2015	41,172	50,288,879	29,966	36,035,849	—	—
1	月	Jan.	5,188	3,384,874	3,106	2,752,120	—	—
2	月	Feb.	3,888	4,326,342	2,659	3,891,147	—	—
3	月	Mar.	1,706	1,629,545	1,249	1,071,558	—	—
4	月	Apr.	2,679	2,125,920	2,119	1,976,359	—	—
5	月	May	3,207	3,913,452	2,497	3,410,799	—	—
6	月	June	2,628	2,298,128	2,059	2,133,204	—	—
7	月	July	2,805	4,487,391	2,167	1,687,528	—	—
8	月	Aug.	3,469	10,612,281	2,556	4,230,689	—	—
9	月	Sep.	2,797	2,833,387	2,092	2,324,977	—	—
10	月	Oct.	3,195	3,314,020	2,346	2,867,969	—	—
11	月	Nov.	3,858	4,289,535	2,869	3,418,328	—	—
12	月	Dec.	5,752	7,074,005	4,247	6,271,170	—	—

資料來源：根據本處財產稅科資料編製。

附 註：本表件數含應稅與免稅。

Table 10. Sources of Deed Tax

Unit : N.T.\$1,000

交換契 Exchange		贈與契 Donation		分割契 Division		占有契 Staking	
件數 Cases	契價 Deed Value	件數 Cases	契價 Deed Value	件數 Cases	契價 Deed Value	件數 Cases	契價 Deed Value
926	1,019,933	5,912	1,519,979	173	193,656	4	914
1,348	1,345,151	6,613	1,688,921	88	38,922	—	—
1,308	1,306,651	6,590	1,721,469	170	418,856	—	—
1,013	911,399	7,015	1,854,852	100	26,046	—	—
894	815,303	7,914	2,207,685	97	153,774	—	—
1,117	1,120,083	8,350	2,490,558	52	11,062	—	—
1,178	1,079,514	9,474	2,771,281	64	18,429	—	—
864	1,283,123	9,215	2,783,729	72	77,512	—	—
779	1,050,449	9,818	2,815,271	130	121,602	—	—
1,271	10,627,430	9,856	3,313,263	79	312,337	—	—
81	166,227	1,993	465,747	8	780	—	—
40	128,939	1,187	306,199	2	58	—	—
50	126,246	392	183,082	15	248,660	—	—
23	25,821	533	123,626	4	113	—	—
68	247,494	631	218,332	11	36,828	—	—
50	35,827	517	129,047	2	50	—	—
146	2,643,346	492	156,517	—	—	—	—
309	6,137,831	597	243,182	7	578	—	—
91	298,282	605	205,135	9	4,992	—	—
187	227,141	663	219,594	-1	-684	—	—
114	444,216	871	420,503	4	6,488	—	—
112	146,061	1,375	642,300	18	14,474	—	—

表 11 印花稅稅源 ①

單位：新臺幣千元

年 度 (月) 別 Fiscal Year (Month)	合 計① Total	出 售 印 花 稅 票 Taxes Stamps	總		
			金融業 Finance	保 險 業 Insurance	傳 播 業 Broadcasting
<b>100 年 度 FY2011</b>	<b>4,232,189</b>	<b>514,547</b>	<b>1,175,596</b>	<b>616,064</b>	<b>1,978</b>
<b>101 年 度 FY2012</b>	<b>4,466,450</b>	<b>477,820</b>	<b>1,182,223</b>	<b>684,628</b>	<b>1,926</b>
<b>102 年 度 FY2013</b>	<b>4,381,501</b>	<b>448,112</b>	<b>1,223,112</b>	<b>706,812</b>	<b>1,815</b>
<b>103 年 度 FY2014</b>	<b>4,559,596</b>	<b>481,664</b>	<b>1,294,717</b>	<b>747,219</b>	<b>1,837</b>
<b>104 年 度 FY2015</b>	<b>4,529,341</b>	<b>462,108</b>	<b>1,336,906</b>	<b>784,326</b>	<b>1,781</b>
1 月 Jan.	629,808	49,702	225,004	125,624	268
2 月 Feb.	84,221	31,732	1	0	—
3 月 Mar.	597,999	20,309	212,846	138,897	293
4 月 Apr.	78,827	25,781	35	4	—
5 月 May	611,411	25,015	235,421	124,854	312
6 月 June	105,827	27,734	0	3	—
7 月 July	689,542	60,273	221,843	132,805	338
8 月 Aug.	151,697	72,407	78	—	—
9 月 Sep.	691,451	59,216	224,127	139,362	309
10 月 Oct.	110,692	38,978	9	—	—
11 月 Nov.	601,602	28,105	217,447	122,777	260
12 月 Dec.	176,263	22,858	96	—	—

資料來源：根據本處機會稅科資料編製。

附 註：①101年以前為本年度實徵數，102年起為本年度實徵淨額。

Table 11. Sources of Stamp Tax ①

Unit : N.T.\$1,000

繳				Total Payment	違章補繳 Payment on Tax Evasion
公用事業 Utilities	承攬契據 Construction agreements	財產契據 Real Estate Deed	其他 Others		
23,682	500,736	315,310	1,084,271	5	
23,304	629,040	283,867	1,183,611	31	
26,789	537,595	324,602	1,112,238	427	
16,084	609,806	309,045	1,098,995	230	
19,936	429,019	421,329	1,073,594	342	
4,660	23,560	30,571	170,416	3	
—	30,380	21,564	544	—	
3,219	32,582	24,969	164,884	1	
—	31,664	20,393	950	1	
3,385	24,443	21,025	176,958	—	
—	51,487	25,721	883	—	
4,066	34,907	34,399	200,911	—	
—	47,689	29,313	2,210	0	
2,741	46,769	29,767	189,018	142	
—	31,047	39,611	1,031	17	
1,864	27,068	39,793	164,288	—	
—	47,426	104,203	1,501	179	

表 12 娛 樂 稅 稅 源

金額單位：新臺幣元

年 度 (月) 別 Fiscal Year (Month)			合 計 Total		電 影 Movies	
			家 數 Unit	實 徵 稅 額 Net Amount Remitted	家 數 Unit	實 徵 稅 額 Net Amount Remitted
95	年 度	FY2006	2,037	243,999,753	40	48,012,314
96	年 度	FY2007	1,859	197,243,270	38	46,686,982
97	年 度	FY2008	1,781	212,488,992	37	39,388,243
98	年 度	FY2009	1,718	210,022,962	33	42,732,259
99	年 度	FY2010	1,671	226,872,556	36	52,681,026
100	年 度	FY2011	1,677	243,807,447	36	60,653,547
101	年 度	FY2012	1,624	224,137,868	37	57,768,614
102	年 度	FY2013	1,615	228,927,370	37	61,062,114
103	年 度	FY2014	1,549	234,874,808	37	61,738,090
104	年 度	FY2015	1,490	278,078,283	36	66,714,939
	1 月	Jan.	1,567	19,907,216	37	4,444,895
	2 月	Feb.	1,497	16,782,667	36	5,203,936
	3 月	Mar.	1,479	21,493,770	38	5,641,036
	4 月	Apr.	1,494	21,815,780	38	4,303,900
	5 月	May	1,499	21,388,624	36	7,213,606
	6 月	June	1,505	29,145,367	36	5,200,630
	7 月	July	1,469	23,036,016	35	7,485,377
	8 月	Aug.	1,466	19,451,600	36	7,264,281
	9 月	Sep.	1,437	36,589,858	36	6,199,252
	10 月	Oct.	1,576	28,043,391	36	4,553,894
	11 月	Nov.	1,455	19,504,955	36	5,028,855
	12 月	Dec.	1,490	20,919,039	36	4,175,277

資料來源：根據本處機會稅科資料編製。

附 註：①其他欄內包括臨時公演及夜總會、戲劇等。

Table 12. Sources of Amusement Tax

Unit : N.T.\$1

歌廳 Sing Halls		撞球場 Billiards Halls		保齡球 Bowling Alleys	
家數 Unit	實徵稅額 Net Amount Remitted	家數 Unit	實徵稅額 Net Amount Remitted	家數 Unit	實徵稅額 Net Amount Remitted
1	36,493	85	3,121,034	5	714,498
1	72,420	3	1,533,854	—	389,013
1	72,420	—	125,365	—	—
1	72,180	—	49,682	—	—
1	72,300	—	42,342	—	—
1	75,908	—	57,915	—	—
1	72,420	—	—	—	—
1	72,420	—	—	—	—
2	128,120	—	—	—	—
2	100,965	—	—	—	—
2	11,706	—	—	—	—
2	6,158	—	—	—	—
2	11,645	—	—	—	—
2	6,158	—	—	—	—
2	8,932	—	—	—	—
2	8,932	—	—	—	—
2	8,932	—	—	—	—
2	8,932	—	—	—	—
2	6,158	—	—	—	—
2	2,774	—	—	—	—
2	17,864	—	—	—	—
2	2,774	—	—	—	—

表 12 娛 樂 稅 稅 源 ( 續 )

金額單位：新臺幣元

年 度 ( 月 ) 別 Fiscal Year ( Month )	高爾夫球練習場 Golf		舞廳 ( 場 ) Dance Halls		電子遊戲機 Electric Toys	
	家數 Unit	實徵稅額 Net Amount Remitted	家數 Unit	實徵稅額 Net Amount Remitted	家數 Unit	實徵稅額 Net Amount Remitted
95 年 度 FY2006	13	3,846,895	42	22,974,644	111	9,239,571
96 年 度 FY2007	13	2,407,224	32	17,620,681	86	8,960,627
97 年 度 FY2008	14	-6,539,283	32	15,664,322	78	8,313,668
98 年 度 FY2009	14	3,003,059	27	13,659,294	78	6,683,071
99 年 度 FY2010	14	3,092,520	28	12,137,962	70	6,257,564
100 年 度 FY2011	14	3,510,075	26	10,112,917	68	5,801,330
101 年 度 FY2012	16	3,424,660	21	9,148,763	65	5,721,201
102 年 度 FY2013	19	3,250,593	22	10,243,677	53	5,101,660
103 年 度 FY2014	17	3,229,941	22	9,391,384	54	4,535,210
104 年 度 FY2015	14	3,100,503	22	10,819,901	54	4,638,371
1 月 Jan.	17	285,501	24	977,126	55	360,684
2 月 Feb.	17	289,320	22	903,430	55	371,181
3 月 Mar.	16	248,166	21	817,505	55	423,062
4 月 Apr.	16	240,437	22	846,776	55	325,336
5 月 May	16	264,687	21	854,607	56	437,021
6 月 June	16	277,646	22	972,306	56	393,931
7 月 July	14	245,422	22	942,689	54	375,351
8 月 Aug.	16	258,716	23	937,784	54	391,123
9 月 Sep.	16	230,371	23	888,065	53	355,060
10 月 Oct.	14	211,964	21	892,051	54	380,788
11 月 Nov.	15	299,631	22	923,000	55	396,229
12 月 Dec.	14	248,642	22	864,562	54	428,605

Table 12. Sources of Amusement Tax (Cont.)

Unit : N.T.\$1

有節目餐飲業 Entertainment Restaurants		MTV等視聽業 MTV Audiovisual Services		其他① Others	
家數 Unit	實徵稅額 Net Amount Remitted	家數 Unit	實徵稅額 Net Amount Remitted	家數 Unit	實徵稅額 Net Amount Remitted
41	5,183,399	1,330	103,915,313	369	46,955,592
37	5,440,419	1,262	77,130,597	387	37,001,453
29	5,442,995	1,243	93,469,130	347	56,552,132
31	3,977,099	1,184	77,448,808	350	62,397,510
37	3,747,894	1,143	76,850,740	342	71,990,208
36	4,246,597	1,158	77,062,565	338	82,286,593
37	4,329,054	1,102	73,187,045	345	70,486,111
41	3,879,719	1,065	71,752,214	377	73,564,973
42	4,830,524	1,009	71,490,428	366	79,531,111
45	4,925,127	951	70,882,463	366	116,896,014
44	471,409	1,012	6,140,072	376	7,215,823
41	384,555	997	5,683,965	327	3,940,122
44	453,407	992	7,548,645	311	6,350,304
45	481,600	982	5,655,086	334	9,956,487
45	557,742	970	5,329,882	353	6,722,147
46	395,672	966	6,185,832	361	15,710,418
44	393,707	959	5,577,968	339	8,006,570
43	359,978	960	5,768,741	332	4,462,045
43	338,791	955	5,713,726	309	22,858,435
42	358,871	955	5,712,793	452	15,930,256
45	384,616	948	5,904,594	332	6,550,166
45	344,779	951	5,661,159	366	9,193,241

表 13 違章漏稅案件處理及財務罰鍰執行情形

單位 { 件數：件  
金額：新臺幣千元

年度及稅目別 Fiscal Year & Item of Tax	受理情形 No. of Cases Accepted			本期審理情形	
	合計 Total	上期未 結件數 Unclosed Cases of Last Term	本期受 理件數 Cases Accepted in this Term	依法免 議件數 Cases Not Indictable	依法免 罰件數 Fine Free Cases
95 年 度 FY2006	3,909	61	3,848	80	105
96 年 度 FY2007	5,408	232	5,176	199	73
97 年 度 FY2008	6,799	143	6,656	368	36
98 年 度 FY2009	7,725	37	7,688	398	186
99 年 度 FY2010	14,445	147	14,298	576	2,976
100 年 度 FY2011	7,936	260	7,676	542	1,034
101 年 度 FY2012	6,042	72	5,970	382	726
102 年 度 FY2013	5,635	44	5,591	289	387
103 年 度 FY2014	3,597	61	3,536	221	268
104 年 度 FY2015	6,958	28	6,930	193	559
土 地 稅 Land Tax	11	—	11	2	—
房 屋 稅 House Tax	2	—	2	1	—
使 用 牌 照 稅 Vehicle License Tax	6,922	28	6,894	190	557
契 稅 Deed Tax	—	—	—	—	—
印 花 稅 Stamp Tax	8	—	8	—	—
娛 樂 稅 Amusement Tax	15	—	15	—	2

資料來源：根據本處稅務管理科資料編製。

Table 13. The Management of Cases of Tax Evasion Against Law  
and Execution Status of Fine

Unit: { Case  
N.T.\$1,000

Cases Interrogated in This Term			本期繳納及移送情形 Cases of Find Paid and Transferred to Law Court in This Term					
處罰 Cases Fined		未結 件數 Cases Unclosed	合計 Total		自行繳納 Paid		移送執行 Transferred to Law Court	
件數 Cases	金額 Amount		件數 Cases	金額 Amount	件數 Cases	金額 Amount	件數 Cases	金額 Amount
3,492	59,977	232	3,867	82,339	3,053	53,577	814	28,762
4,993	110,999	143	5,351	93,588	3,070	36,461	2,281	57,127
6,358	187,241	37	6,649	141,108	3,567	56,162	3,082	84,946
6,994	142,501	147	9,527	177,289	2,991	56,029	6,536	121,260
10,633	230,263	260	13,542	253,119	4,703	42,138	8,839	210,981
6,288	101,053	72	13,282	213,703	4,897	31,559	8,385	182,144
4,890	81,560	44	11,727	178,053	4,092	23,740	7,635	154,313
4,898	68,455	61	11,152	162,532	3,543	27,326	7,609	135,206
3,080	49,005	28	7,755	131,268	1,671	11,301	6,084	119,967
6,087	40,910	119	5,805	85,539	796	3,118	5,009	82,421
9	250	—	7	153	7	153	—	—
1	72	—	—	—	—	—	—	—
6,057	38,703	118	5,780	82,662	774	920	5,006	81,742
—	—	—	—	—	—	—	—	—
8	1,784	—	6	2,527	5	2,005	1	522
12	101	1	12	197	10	40	2	157

表 13 違章漏稅案件處理及財務罰鍰執行情形 (續)

單位 { 件數：件  
金額：新臺幣千元

年度及稅目別 Fiscal Year & Item of Tax	更正註銷案件 Case of Revising or Cancelling		本 期	
			合計 Total	
	件數 Cases	金額 Amount	件數 Cases	金額 Amount
95 年 度 FY2006	- 224	26,333	329	11,284
96 年 度 FY2007	- 305	10,162	1,106	31,902
97 年 度 FY2008	- 908	30,551	2,576	59,340
98 年 度 FY2009	-1,399	24,282	4,341	118,649
99 年 度 FY2010	-1,745	15,011	6,478	148,069
100 年 度 FY2011	-1,890	38,177	9,270	219,195
101 年 度 FY2012	-3,553	1,865	6,560	150,690
102 年 度 FY2013	6	33,485	6,996	136,684
103 年 度 FY2014	1,783	35,519	6,881	127,183
104 年 度 FY2015	2,093	57,071	5,540	118,027
土 地 稅 Land Tax	—	—	1	10,914
房 屋 稅 House Tax	—	—	—	—
使 用 牌 照 稅 Vehicle License Tax	2,091	56,341	5,536	106,023
契 稅 Deed Tax	—	—	—	—
印 花 稅 Stamp Tax	1	560	2	1,082
娛 樂 稅 Amusement Tax	1	170	1	8

Table 13. The Management of Cases of Tax Evasion Against Law and Execution Status of Fine (Cont.)

Unit: { Case  
N.T.\$1,000

執行情形 Cases Executed in This Term						截至本期未執行案件 Cases Unexecuted	
移送繳納 Fined Paid		發給執行憑證 Giving Executive Evidence		移送駁回或撤回 Cases of Withdrawn or Rejected			
件數 Cases	金額 Amount	件數 Cases	金額 Amount	件數 Cases	金額 Amount	件數 Cases	金額 Amount
147	6,671	175	4,364	7	249	1,568	587,194
388	12,275	675	17,291	43	2,336	2,743	612,419
813	17,424	1,695	39,871	68	2,045	3,249	638,025
1,405	26,010	2,829	90,581	107	2,058	5,444	640,636
1,750	31,268	4,584	113,901	144	2,900	7,805	703,548
2,118	41,503	7,019	173,858	133	3,834	5,866	180,815
1,816	32,995	4,616	114,427	128	3,268	6,941	184,438
1,938	29,024	4,976	105,960	82	1,700	7,554	182,960
1,877	28,647	4,927	97,115	77	1,421	6,304	165,557
1,376	21,416	4,129	95,819	35	792	5,673	126,496
—	19	1	10,895	—	—	—	—
—	—	—	—	—	—	—	—
1,375	21,389	4,126	83,842	35	792	5,666	107,137
—	—	—	—	—	—	—	—
—	—	2	1,082	—	—	4	19,165
1	8	—	—	—	—	3	194

表 14 各項稅捐滯納案件移送執行情形

金額單位：新臺幣元

年度及稅目別 Fiscal Year & Item of Tax	移送執行數① Executed cases		執行徵起數(1) Executive Levied Tax		掣發債權憑證數(2) Giving Executive Evidence	
	件數 Cases	金額 Amount	件數 Cases	金額 Amount	件數 Cases	金額 Amount
95 年度 FY2006	81,754	1,671,258,452	44,204	1,082,993,724	36,292	240,778,668
96 年度 FY2007	82,875	1,058,039,055	46,559	827,587,893	61,579	497,154,171
97 年度 FY2008	76,381	1,024,567,477	39,497	611,348,255	50,078	439,371,016
98 年度 FY2009	86,642	1,070,882,804	38,327	667,009,679	51,666	481,404,542
99 年度 FY2010	80,769	842,479,642	35,215	573,963,337	54,967	843,341,510
100 年度 FY2011	59,383	727,698,688	32,371	714,712,214	53,687	823,659,132
101 年度 FY2012	55,501	546,330,038	26,548	438,195,809	25,761	262,966,626
102 年度 FY2013	46,641	420,820,836	26,114	331,664,615	23,141	176,463,048
103 年度 FY2014	44,654	411,498,960	25,496	288,609,636	20,152	162,299,899
104 年度 FY2015	43,075	428,150,709	26,151	300,982,249	17,003	180,861,988
地價稅 Land Value Tax	10,719	111,696,518	7,500	102,186,870	2,954	20,861,606
土地增值稅 Land Value Increment Tax	8	24,382,107	4	5,658,015	3	47,493,579
房屋稅 House Tax	7,260	41,199,146	5,824	36,298,037	917	6,071,144
使用牌照稅 Vehicle License Tax	23,074	187,262,098	12,244	115,155,400	11,373	77,153,488
契稅 Deed Tax	12	283,804	8	137,829	2	72,953
印花稅 Stamp Tax	—	—	—	—	—	—
娛樂稅 Amusement Tax	2,002	6,528,462	571	1,827,925	1,754	3,415,784
罰鍰② Fine	—	56,798,574	—	39,718,173	—	25,793,434

資料來源：根據本處稅務管理科資料編製。

附註：①包括以前年度移送未執行結轉數。

②罰鍰係指本稅以外之短估金、滯(怠)報金、滯納金及加計利息等之合計數，為附加稅，故不計件數。

③101年度以前係指結案數。

Table 14. The Status of Delayed Case Transferred to Execution

Unit : N.T.\$1

撤退案數(3) Cases of Withdrawn		稅捐處清理數③(1+2+3=4) Closed Cases		移送尚未執行數 Unexecuted Cases	
件數 Cases	金額 Amount	件數 Cases	金額 Amount	件數 Cases	金額 Amount
4,074	176,829,888	84,570	1,500,602,280	144,239	3,996,599,528
3,946	101,388,745	112,084	1,426,130,809	111,010	3,564,275,012
2,338	104,810,618	91,913	1,155,529,889	92,189	3,380,106,899
1,977	35,843,492	91,970	1,184,257,713	83,718	3,209,836,714
1,851	24,838,280	92,033	1,442,143,127	70,335	2,560,047,010
933	15,260,562	86,991	1,553,631,908	41,370	1,603,167,185
1,017	14,761,965	53,326	715,924,400	42,845	1,395,183,086
520	6,656,743	49,775	514,784,406	4,307	151,801,244
318	3,398,005	45,966	454,307,540	36,989	1,234,841,497
221	6,775,138	43,375	488,619,375	35,932	1,162,575,765
57	3,443,659	10,511	126,492,135	8,500	403,329,105
—	—	7	53,151,594	14	319,306,477
32	1,352,895	6,773	43,722,076	6,658	122,033,490
119	1,044,164	23,736	193,353,052	19,071	142,418,458
—	—	10	210,782	7	305,780
—	—	—	—	—	—
13	37,571	2,338	5,281,280	1,682	7,095,332
—	896,849	—	66,408,456	—	168,087,123

表 15 查(核)定開徵數及未徵數情形

單位 { 件數：件  
金額：新臺幣千元

## 一. 本年度

年度及稅目別 Fiscal Year & Item of Tax	查(核)定開徵數 Opening Collection for Assessed(Verified) (1)		實徵數 Tax Collected (2)		減免註銷數 Cancelled (3)		逾徵收 期限數 Overdue (4)	
	件數 Cases	金額 Amount	件數 Cases	金額 Amount	件數 Cases	金額 Amount	件數 Cases	金額 Amount
100 年度 FY2011	3,008,150	63,464,263	2,912,650	59,970,637	29,434	2,144,176	—	—
101 年度 FY2012	3,041,661	64,291,613	2,950,791	60,881,995	23,796	1,568,405	—	—
102 年度 FY2013	3,061,761	68,463,016	2,974,908	64,981,290	25,022	2,069,634	—	—
103 年度 FY2014	3,098,137	70,702,817	3,005,973	66,230,222	32,645	3,324,245	—	—
104 年度 FY2015	3,177,942	81,454,591	3,087,289	75,689,692	26,624	4,651,618	—	—
地價稅 Land Value Tax	891,641	22,501,133	856,549	21,715,847	1,916	301,119	—	—
土地增值稅 Land Value Increment Tax	68,787	29,642,029	64,236	25,568,874	3,814	3,723,559	—	—
房屋稅 House Tax	1,073,972	14,383,202	1,058,190	14,137,991	6,609	143,553	—	—
使用牌照稅 Vehicle License Tax	972,533	7,671,652	950,363	7,323,486	6,912	235,425	—	—
契稅 Deed Tax	43,848	2,810,258	41,801	2,599,963	1,805	194,999	—	—
印花稅 Stamp Tax	103,248	4,128,607	95,945	4,054,119	5,056	46,336	—	—
娛樂稅 Amusement Tax	18,822	283,314	17,677	275,791	388	5,139	—	—
罰鍰 Fine	5,091	34,395	2,528	13,621	124	1,489	—	—

資料來源：根據本處稅務管理科資料編製。

附註：1.本表以開徵始日為統計基礎。

2.實徵數之件數及金額未包含實徵當查定部分。

Table 15. The Management of Opening Collection for Assessed (Verified) and of Tax Not Collected

Unit:  $\begin{cases} \text{Case} \\ \text{N.T.}\$1,000 \end{cases}$

1. Current Year

逾核課期限數 Excess Assessment (5)		未徵數餘額 Balance of Tax Not Collected					
		合計 Total (6)=(1)-(2)-(3)-(4)-(5)		繳款書未送達 未徵數 Have Not Been Served the Payment Notice		未逾限繳日 未徵數 Have Not Exceeded the Deadline of Payment	
件數 Cases	金額 Amount	件數 Cases	金額 Amount	件數 Cases	金額 Amount	件數 Cases	金額 Amount
14	55	66,052	1,349,395	28,618	487,570	16,925	501,801
15	49	67,059	1,841,163	29,703	881,553	19,519	561,446
13	58	61,818	1,412,034	28,370	668,134	15,015	430,539
9	141	59,510	1,148,209	27,334	299,768	14,530	499,542
7	101	64,022	1,113,179	28,309	222,583	16,100	595,051
3	76	33,173	484,091	26,638	156,717	5,607	227,149
—	—	737	349,596	275	55,934	450	286,526
—	—	9,173	101,658	583	1,876	3,228	21,878
4	25	15,254	112,716	549	3,396	3,678	16,037
—	—	242	15,296	50	3,564	186	10,827
—	—	2,247	28,153	98	852	2,147	27,284
—	—	757	2,384	114	237	128	229
—	—	2,439	19,285	2	7	676	5,121

表 15 查(核)定開徵數及未徵數情形 (續1)

單位 { 件數：件  
金額：新臺幣千元

## 一.本年度

年度及稅目別 Fiscal Year & Item of Tax	未徵數餘額							
	行政救濟 未徵數 Administrative Remedies		分期繳納 未徵數 Pay by Stages		特殊原因 未徵數 Special Reason		欠	
							小計	
	件數 Cases	金額 Amount	件數 Cases	金額 Amount	件數 Cases	金額 Amount	件數 Cases	金額 Amount
100 年度 FY2011	138	28,466	—	—	462	81	19,909	331,478
101 年度 FY2012	199	154,138	—	—	187	97	17,451	243,929
102 年度 FY2013	96	70,784	—	—	232	124	18,105	242,454
103 年度 FY2014	89	115,982	—	—	231	230	17,326	232,689
104 年度 FY2015	164	123,635	—	—	257	105	19,192	171,805
地 價 稅 Land Value Tax	44	65,532	—	—	7	4	877	34,689
土 地 增 值 稅 Land Value Increment Tax	9	7,027	—	—	—	—	3	109
房 屋 稅 House Tax	106	50,796	—	—	167	33	5,089	27,075
使 用 牌 照 稅 Vehicle License Tax	—	—	—	—	67	66	10,960	93,217
契 稅 Deed Tax	—	—	—	—	—	—	6	906
印 花 稅 Stamp Tax	1	17	—	—	1	0	—	—
娛 樂 稅 Amusement Tax	—	—	—	—	14	2	501	1,916
罰 鍰 Fine	4	263	—	—	1	0	1,756	13,893

Table 15. The Management of Opening Collection for Assessed (Verified) and of Tax Not Collected (Cont.1)

Unit: { Case  
N.T.\$1,000

1. Current Year

Balance of Tax Not Collected							
稅		數		Pending Tax Arrears			
送達未逾滯納期 Service of Notice Has Not Exceeded Delinquency Period		移送執行未結 Transferred to Law Court Not Yet Closed		執行憑證數 Executive Evidence		其他 Others	
件數 Cases	金額 Amount	件數 Cases	金額 Amount	件數 Cases	金額 Amount	件數 Cases	金額 Amount
2,379	38,893	11,643	108,743	1,897	16,956	3,990	166,886
2,896	26,988	10,106	93,600	824	7,616	3,625	115,725
2,021	16,523	11,911	104,187	603	5,041	3,570	116,703
1,909	71,693	12,504	111,676	1,007	9,670	1,906	39,649
4,480	37,935	11,249	84,569	563	4,158	2,900	45,142
217	4,849	162	922	2	4	496	28,913
—	—	—	—	—	—	3	109
666	2,894	3,647	21,120	6	8	770	3,053
3,103	25,067	6,180	54,290	366	3,068	1,311	10,792
6	906	—	—	—	—	—	—
—	—	—	—	—	—	—	—
77	143	297	1,534	89	182	38	58
411	4,076	963	6,703	100	896	282	2,217

表 15 查(核)定開徵數及未徵數情形 (續2)

單位 { 件數：件  
金額：新臺幣千元

## 二. 以前年度

年度及稅目別 Fiscal Year & Item of Tax	查(核)定開徵數①		實徵數		減免註銷數		逾徵收 期限數	
	Opening Collection for Assessed(Verified) (1)		Tax Collected (2)		Cancelled (3)		Overdue (4)	
	件數 Cases	金額 Amount	件數 Cases	金額 Amount	件數 Cases	金額 Amount	件數 Cases	金額 Amount
100 年度 FY2011	220,787	4,341,814	93,336	1,752,666	6,370	113,053	17,745	388,801
101 年度 FY2012	184,058	3,393,966	76,631	1,306,722	1,214	61,911	17,482	204,789
102 年度 FY2013	168,974	3,016,747	76,703	1,146,773	478	75,169	13,596	117,944
103 年度 FY2014	149,916	2,911,044	69,114	947,241	-861	81,493	14,123	120,263
104 年度 FY2015	137,313	2,840,678	67,316	1,027,413	-523	25,530	9,820	101,197
地價稅 Land Value Tax	49,559	939,378	33,122	373,946	106	4,116	1,080	6,665
土地增值稅 Land Value Increment Tax	1,271	1,030,229	987	442,612	113	8,360	1	361
房屋稅 House Tax	13,393	203,422	8,166	65,146	152	3,441	250	1,174
使用牌照稅 Vehicle License Tax	49,983	289,442	17,907	79,921	-1,445	399	5,911	34,676
契稅 Deed Tax	419	21,817	352	19,794	56	1,592	1	8
印花稅 Stamp Tax	3,702	21,537	3,285	20,255	416	1,283	1	0
娛樂稅 Amusement Tax	4,179	12,259	818	2,312	-3	-44	486	1,281
罰鍰 Fine	14,807	322,594	2,679	23,427	82	6,385	2,090	57,033

資料來源：根據本處稅務管理科資料編製。

附註：①係原開徵始日在上年度12月31日以前之查(核)定開徵稅款，未逾徵收期間而仍未徵起者。

Table 15. The Management of Opening Collection for Assessed (Verified) and of Tax Not Collected (Cont.2)

Unit:  $\begin{cases} \text{Case} \\ \text{N.T. \$1,000} \end{cases}$

逾核課期限數 Excess Assessment (5)		2. Previous Year 未徵數餘額 Balance of Tax Not Collected					
		合計 Total (6)=(1)-(2)-(3)-(4)-(5)		繳款書未送達 未徵數 Have Not Been Served the Payment Notice		未逾限繳日 未徵數 Have Not Exceeded the Deadline of Payment	
件數 Cases	金額 Amount	件數 Cases	金額 Amount	件數 Cases	金額 Amount	件數 Cases	金額 Amount
918	12,931	102,418	2,074,364	994	41,979	318	5,219
691	8,148	88,040	1,812,398	695	25,858	271	9,926
295	4,124	77,902	1,672,737	672	63,134	157	2,656
282	10,341	67,258	1,751,706	721	47,788	275	234,801
313	7,896	60,387	1,678,641	638	19,240	342	298,214
219	7,251	15,032	547,400	580	9,367	83	54,283
—	—	170	578,896	29	9,742	108	242,471
3	1	4,822	133,660	15	57	87	785
88	606	27,522	173,840	14	74	63	476
—	—	10	423	—	—	—	—
—	—	—	—	—	—	—	—
—	—	2,878	8,711	—	—	—	—
3	38	9,953	235,713	—	—	1	200

表 15 查(核)定開徵數及未徵數情形 (續3完)

單位 { 件數：件  
金額：新臺幣千元

## 二.以前年度

年度及稅目別 Fiscal Year & Item of Tax	未徵數餘額							
	行政救濟 未徵數 Administrative Remedies		分期繳納 未徵數 Pay by Stages		特殊原因 未徵數 Special Reason		欠	
							小計	
	件數 Cases	金額 Amount	件數 Cases	金額 Amount	件數 Cases	金額 Amount	件數 Cases	金額 Amount
100 年度 FY2011	87	48,158	—	—	5,127	17,124	95,892	1,961,883
101 年度 FY2012	66	107,657	—	—	4,702	20,447	82,306	1,648,510
102 年度 FY2013	206	64,554	—	—	4,512	24,114	72,264	1,517,626
103 年度 FY2014	197	37,379	—	—	3,713	20,956	62,352	1,410,783
104 年度 FY2015	28	61,213	—	—	3,049	20,599	56,330	1,279,375
地 價 稅 Land Value Tax	10	32,654	—	—	1,725	19,529	12,634	431,568
土 地 增 值 稅 Land Value Increment Tax	5	3,663	—	—	—	—	28	323,019
房 屋 稅 House Tax	13	24,896	—	—	455	88	4,252	107,833
使 用 牌 照 稅 Vehicle License Tax	—	—	—	—	826	791	26,619	172,499
契 稅 Deed Tax	—	—	—	—	—	—	10	423
印 花 稅 Stamp Tax	—	—	—	—	—	—	—	—
娛 樂 稅 Amusement Tax	—	—	—	—	30	5	2,848	8,705
罰 鍰 Fine	—	—	—	—	13	185	9,939	235,327

Table 15. The Management of Opening Collection for Assessed (Verified) and of Tax Not Collected (Cont.3 End)

## 2. Previous Year

Unit: { Case  
N.T.\$1,000

Balance of Tax Not Collected							
Pending Tax Arrears							
稅 數		移送執行未結		執行憑證數		其 他	
送達未逾滯納期 Service of Notice Has Not Exceeded Delinquency Period		Transferred to Law Court Not Yet Closed		Executive Evidence		Others	
件數 Cases	金額 Amount	件數 Cases	金額 Amount	件數 Cases	金額 Amount	件數 Cases	金額 Amount
115	881	20,254	1,219,373	75,114	723,418	409	18,210
65	361	14,602	1,001,966	67,306	635,422	333	10,761
30	364	14,025	952,511	58,119	563,693	181	1,711
66	584	13,012	912,598	49,093	496,408	181	1,193
94	2,095	12,404	856,384	43,632	416,342	200	4,553
47	436	5,471	367,962	6,998	61,045	118	2,124
12	1,494	12	319,256	2	51	2	2,219
2	7	2,125	96,459	2,095	11,311	30	56
28	123	3,602	30,122	22,957	142,201	32	52
—	—	2	256	8	167	—	—
—	—	—	—	—	—	—	—
—	—	301	2,218	2,546	6,487	1	0
5	35	891	40,111	9,026	195,079	17	102

表 16 各項稅捐現行稅率表

稅別	課 徵 標 的 及 稅 率			
地          價          稅	地價稅累進起點地價，以本市土地 7 公畝之平均地價為準。但不包括工業用地、礦業用地、農業用地及免稅土地在內。			
	土地類別	級別	累 進 地 價 級 距	稅 率
	私 有 一 般 土 地	1	未超過累進起點地價部分	10 ‰
		2	超過累進起點地價未達 5 倍者，其超過部分	15 ‰
		3	超過累進起點地價 5 倍至 10 倍者，其超過部分	25 ‰
		4	超過累進起點地價 10 倍至 15 倍者，其超過部分	35 ‰
		5	超過累進起點地價 15 倍至 20 倍者，其超過部分	45 ‰
		6	超過累進起點地價 20 倍以上者，其超過部分	55 ‰
	公 有 土 地			10 ‰
	工業用地、加油站、停車場等事業直接使用之土地等			10 ‰
公 共 設 施 保 留 地			6 ‰	
自用住宅、國民住宅及勞工宿舍用地			2 ‰	

表 16 各項稅捐現行稅率表（續 1）

稅別	稅級別	計 算 公 式
土 地 增 值 稅	第一級	應徵稅額＝土地漲價總數額〔超過原規定地價或前次移轉時申報現值（按臺灣地區消費者物價總指數調整後）未達百分之一百者〕×稅率（20%）。
	第二級	<p>應徵稅額＝土地漲價總數額【超過原規定地價或前次移轉時申報現值（按臺灣地區消費者物價總指數調整後）在百分之一百以上未達百分之二百者】×【稅率（30%）－〔（30%－20%）×減徵率〕】－累進差額（按臺灣地區消費者物價總指數調整後之原規定地價或前次移轉現值×A）。</p> <p>註：持有土地年限未超過 20 年者，無減徵，A 為 0.10。            持有土地年限超過 20 年以上者，減徵率為 20%，A 為 0.08。            持有土地年限超過 30 年以上者，減徵率為 30%，A 為 0.07。            持有土地年限超過 40 年以上者，減徵率為 40%，A 為 0.06。</p>
	第三級	<p>應徵稅額＝土地漲價總數額【超過原規定地價或前次移轉時申報現值（按臺灣地區消費者物價總指數調整後）在百分之二百以上者】×【稅率（40%）－〔（40%－20%）×減徵率〕】－累進差額（按臺灣地區消費者物價總指數調整後之原規定地價或前次移轉現值×B）。</p> <p>註：持有土地年限未超過 20 年者，無減徵，B 為 0.30。            持有土地年限超過 20 年以上者，減徵率為 20%，B 為 0.24。            持有土地年限超過 30 年以上者，減徵率為 30%，B 為 0.21。            持有土地年限超過 40 年以上者，減徵率為 40%，B 為 0.18。</p>
		自用住宅用地稅率一律 10%



表 16 各項稅捐現行稅率表 (續 3)

稅別	稅額 (元) 總排量 (立方公分)	車輛 種類	小客車		大客車	貨車	機器腳踏車
			自用	營業	全年	全年	全年
			全年	全年			
使 用 牌 照 稅	150 以下		—	—	—	—	0
	151~ 250		—	—	—	—	800
	251~ 500		1,620	900	—	900	1,620
	501~ 600		2,160	1,260	1,080	1,080	2,160
	601~ 1,200		4,320	2,160	1,800	1,800	4,320
	1,201~ 1,800		7,120	3,060	2,700	2,700	7,120
	1,801~ 2,400		11,230	6,480	3,600	3,600	(1801c.c.以上)11,230
	2,401~ 3,000		15,210	9,900	4,500	4,500	
	3,001~ 3,600	}	28,220	16,380	5,400	5,400	
	3,601~ 4,200				6,300	6,300	
	4,201~ 4,800	}	46,170	24,300	7,200	7,200	
	4,801~ 5,400				8,100	8,100	
	5,401~ 6,000	}	69,690	33,660	9,000	9,000	
	6,001~ 6,600				9,900	9,900	
	6,601~ 7,200	}	117,000	44,460	10,800	10,800	
	7,201~ 7,800				11,700	11,700	
	7,801~ 8,400	}	151,200	56,700	12,600	12,600	
	8,401~ 9,000				13,500	13,500	
	9,001~ 9,600				14,400	14,400	
9,601~ 10,200				15,300	15,300		
10,201 以上				16,200	16,200		

臨時牌照	
車別	每日稅額
小客車	41
大客車	23
貨車	22
曳引車	28
機器腳踏車	5

試車牌照	
車別	每日稅額
小客車	414
機器腳踏車	30

附註：1. 曳引車之稅額按貨車稅額加徵 30%。

2. 小客貨兩用車之稅額按自用小客車之稅額課徵。

3. 自用車全年 1 期，營業車全年分上、下 2 期課徵。

表 16 各項稅捐現行稅率表 (續 4)

稅別	車輛種類	稅額 (元)		用途	
		馬達最大馬力		自用	營業
		英制馬力(HP)	公制馬力(PS)		
使用牌	(每車乘人座位 9 人以下者) 完全以電能為動力之電動小客車	38 以下	38.6 以下	1,620	900
		38.1~ 56	38.7~ 56.8	2,160	1,260
		56.1~ 83	56.9~ 84.2	4,320	2,160
		83.1~182	84.3~184.7	7,120	3,060
		182.1~262	184.8~265.9	11,230	6,480
		262.1~322	266.0~326.8	15,210	9,900
		322.1~414	326.9~420.2	28,220	16,380
		414.1~469	420.3~476.0	46,170	24,300
		469.1~509	476.1~516.6	69,690	33,660
		509.1 以上	516.7 以上	117,000	44,460
照稅	完全以電能為動力之電動機器腳踏車	12 以下	12.2 以下		0
		12.1-20	12.3-20.3		800
		20.1-45	20.4-45.7		1,620

附註：臺北市政府於 104 年 3 月 3 日公告，本市完全以電能為動力之電動汽車，自 101 年 1 月 6 日起至 107 年 1 月 5 日止免徵使用牌照稅，期滿後自 107 年 1 月 6 日起恢復課稅。

表 16 各項稅捐現行稅率表 (續 5)

稅別	課 徵 標 的	稅 率
娛 樂 稅	一、舞廳、舞場	25 %
	二、電影	
	1. 外國語片 { (1)市區繁榮地帶	2.5 %
	(2)市區偏僻地帶	1.5 %
	(3)郊區	1 %
	2. 本國語片 { (1)市區繁榮地帶	1 %
	(2)市區偏僻地帶	1 %
	(3)郊區	1 %
	三、高爾夫球練習場	2.5 %
	四、職業性歌唱、舞蹈、馬戲、魔術、技藝表演及夜總會之各種表演。	5 %
五、各種競技比賽及其他提供娛樂設施供人娛樂者。	2.5 %	
六、說書、戲劇、音樂演奏及非職業性歌唱、舞蹈等表演。	1.25 %	
契 稅	一、買賣契按契價	6 %
	二、典權契按契價	4 %
	三、交換契按契價	2 %
	四、贈與契按契價	6 %
	五、分割契按契價	2 %
	六、占有契按契價	6 %



表 17 各項稅捐劃解分配率

104 年度

單位：百分比

稅目	繳庫別	
	國	庫
地價稅	—	100
土地增值稅	—	100
房屋稅	—	100
使用牌照稅	—	100
契稅	—	100
印花稅	—	100
娛樂稅	—	100

表 18 本處各項稅捐稽徵工作流程圖

(一)地 價 稅



表 18 本處各項稅捐稽徵工作流程圖（續 1）  
（二）土地增值稅



表 18 本處各項稅捐稽徵工作流程圖 (續 2)

(三)房 屋 稅

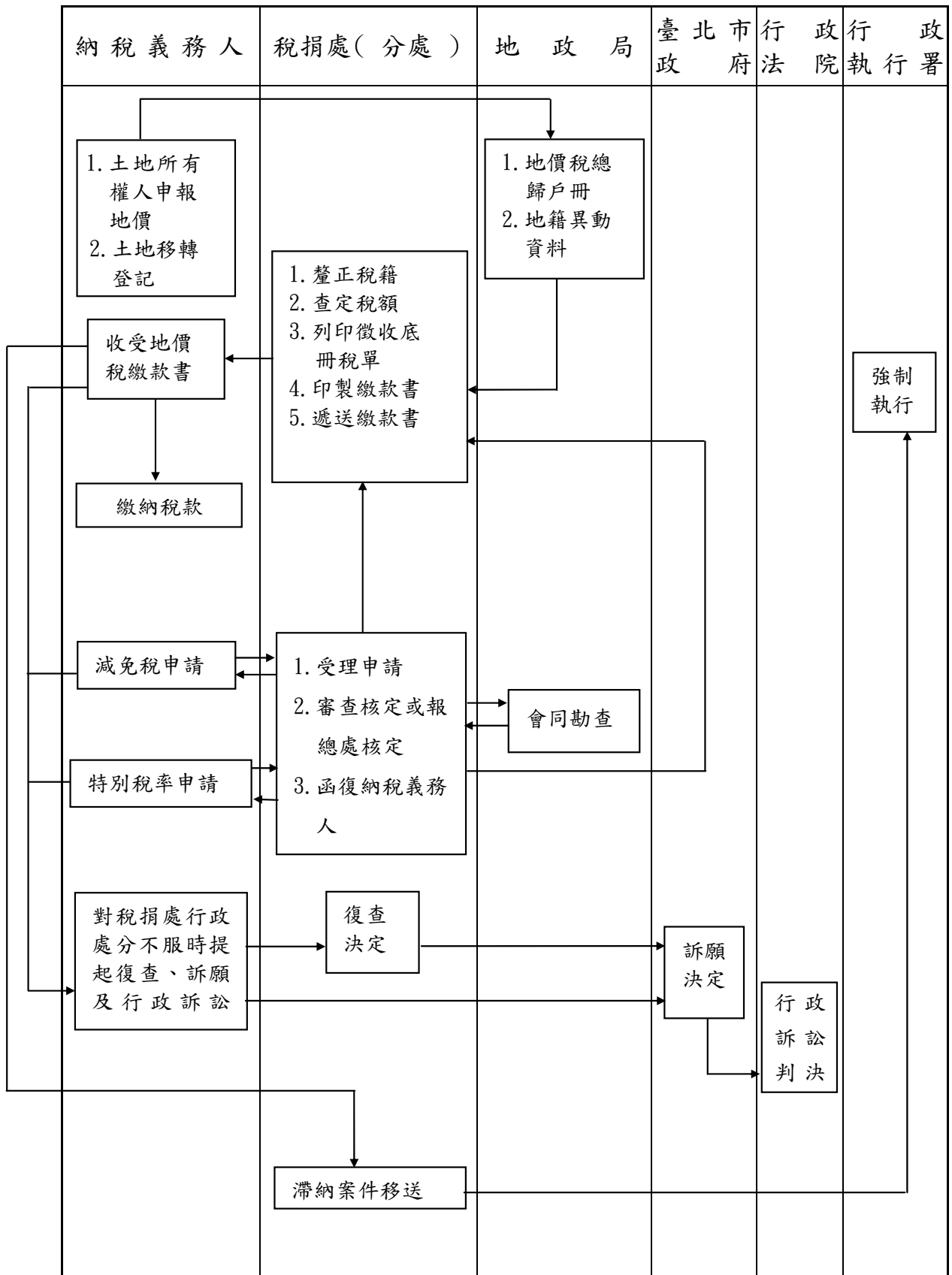

表 18 本處各項稅捐稽徵工作流程圖（續 3）

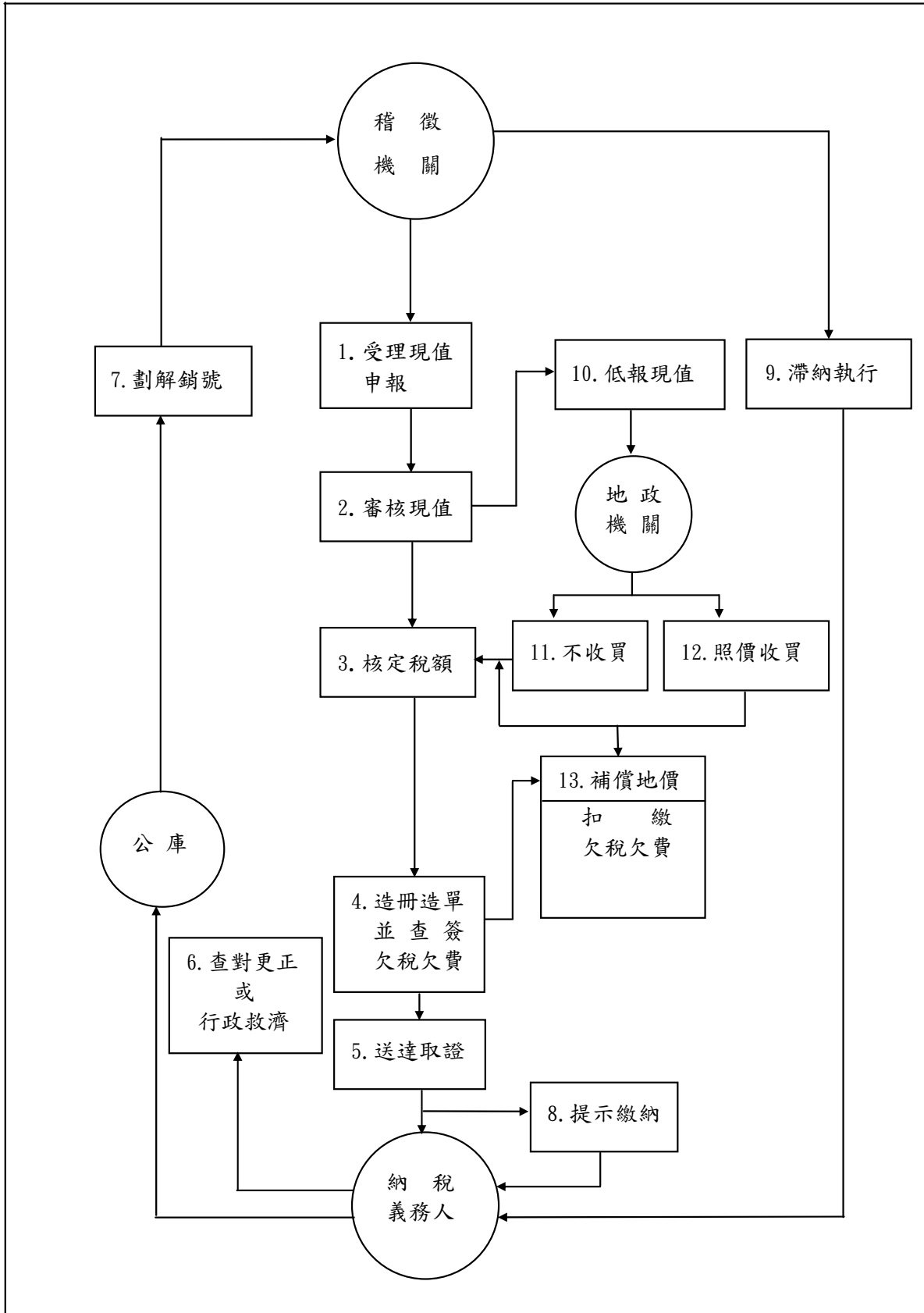
(四)使用牌照稅

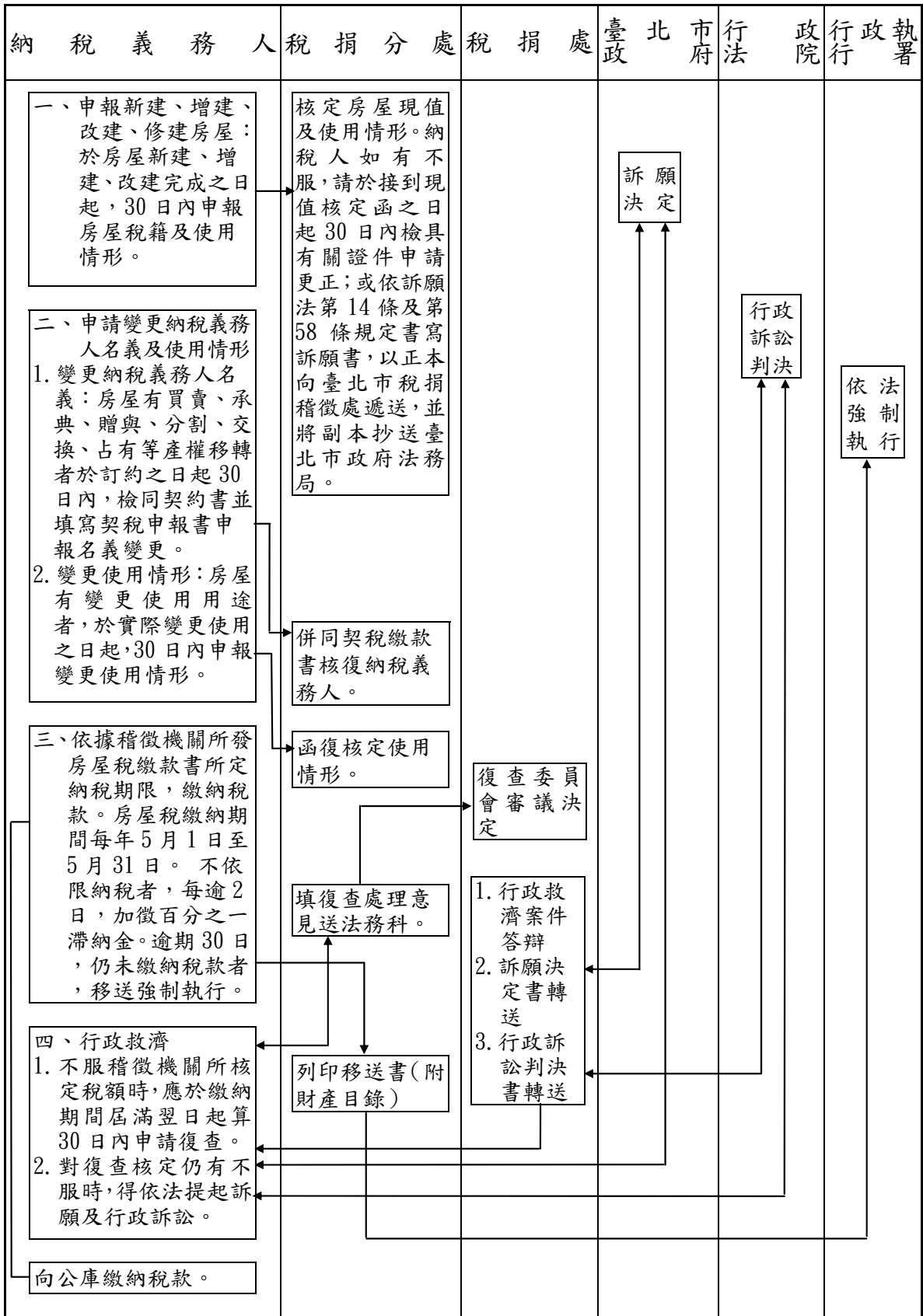

表 18 本處各項稅捐稽徵工作流程圖（續 4）

(五)契 稅

納 稅 義 務 人	稅 捐 分 處	地 事 務 所	政 務 所 行 政 執 行 署	
<p>不動產所有權移轉契約成立之日起30日內申報契稅</p> <p>↓</p> <p>1. 公定格式契約書 2. 契稅申報書 3. 有關證件 4. 委託代理人申報者應在申報書內加蓋代理人印章</p> <p>↓</p> <p>向公庫繳納稅款後，將繳納通知書第5聯黏貼於買賣等契約書副本隨登記書表送地政機關存查</p> <p>↓</p> <p>未依限繳納稅款，每逾2日，加徵應納稅額百分之一滯納金，逾期30日仍不繳納者移送法院強制執行。</p>	<p>1. 審查契價 2. 核算稅額 3. 編冊造單 4. 遞送稅單</p> <p>↓</p> <p>列印財產目錄及移送書</p>	<p>產 權 變 更 登 記</p>	<p>強制執行</p>	
行 政 救 濟	稅 捐 處	臺 北 市 政 府	臺 北 高 等 行 政 法 院	最 高 行 政 法 院
<p>對核定稅額不服，應於繳納期間屆滿翌日起算30日內，申請復查。</p> <p>↓</p> <p>對復查決定不服</p> <p>↓</p> <p>提 起 訴 願</p> <p>↓</p> <p>行 政 訴 訟</p> <p>↓</p> <p>上 訴</p>	<p>復 查 決 定</p>	<p>訴 願 決 定</p>	<p>判 決</p>	<p>判 決</p>

表 18 本處各項稅捐稽徵工作流程圖 (續 5)  
(六)印 花 稅

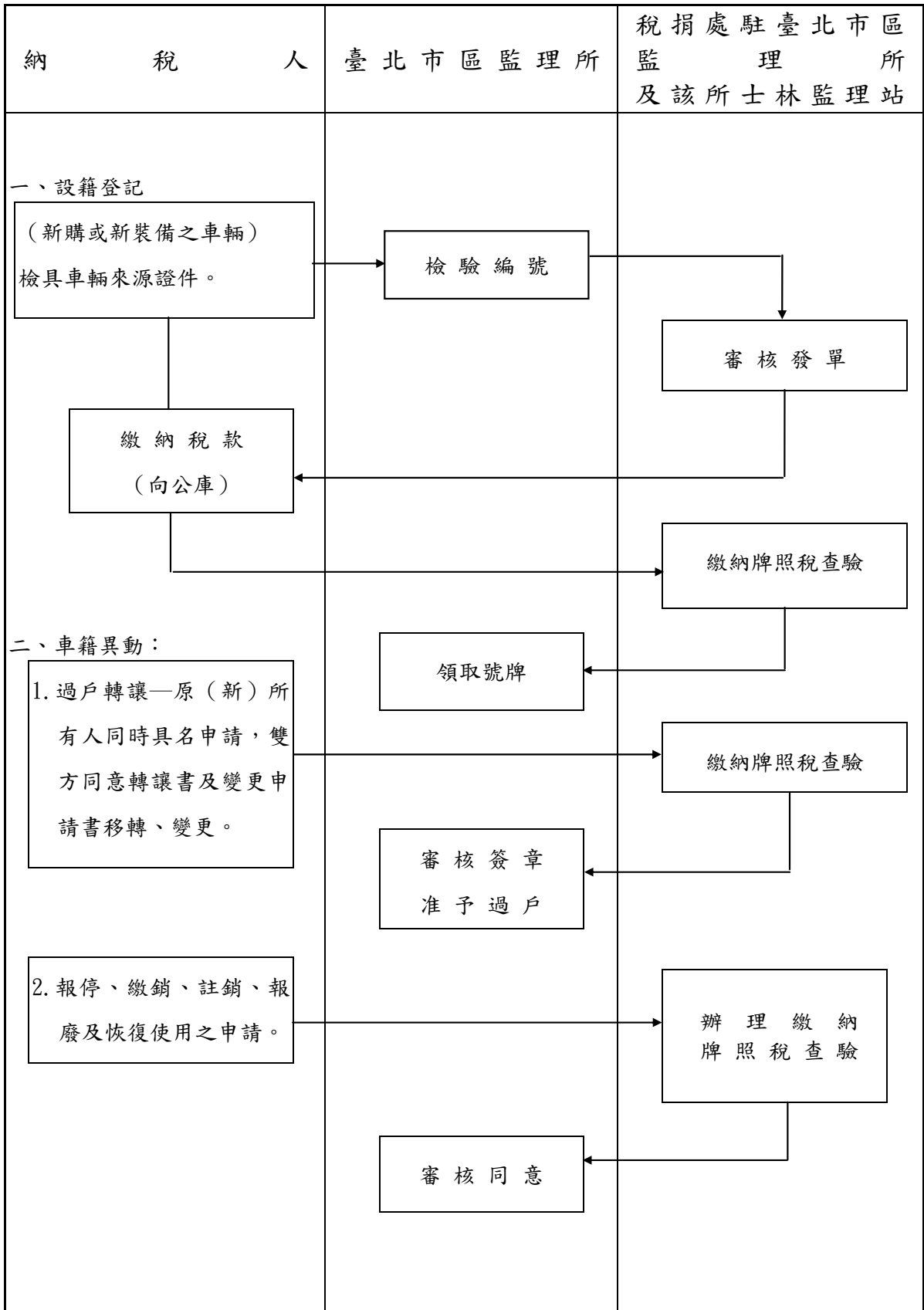

表 18 本處各項稅捐稽徵工作流程圖 (續 6)  
(七) 娛樂稅



表 18 本處各項稅捐稽徵工作流程圖 (續 7 完)  
(八) 支票退稅



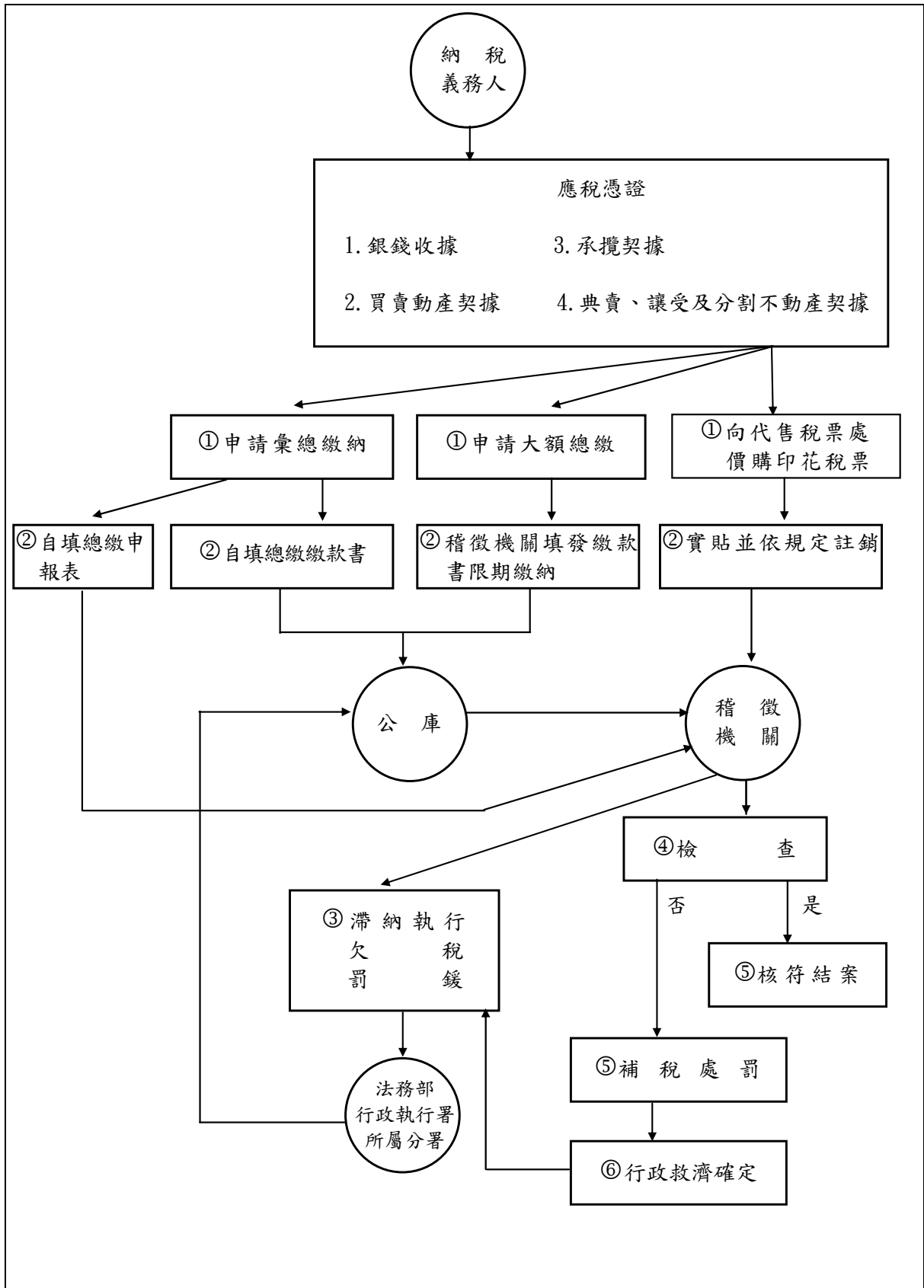

## 肆、行政組織

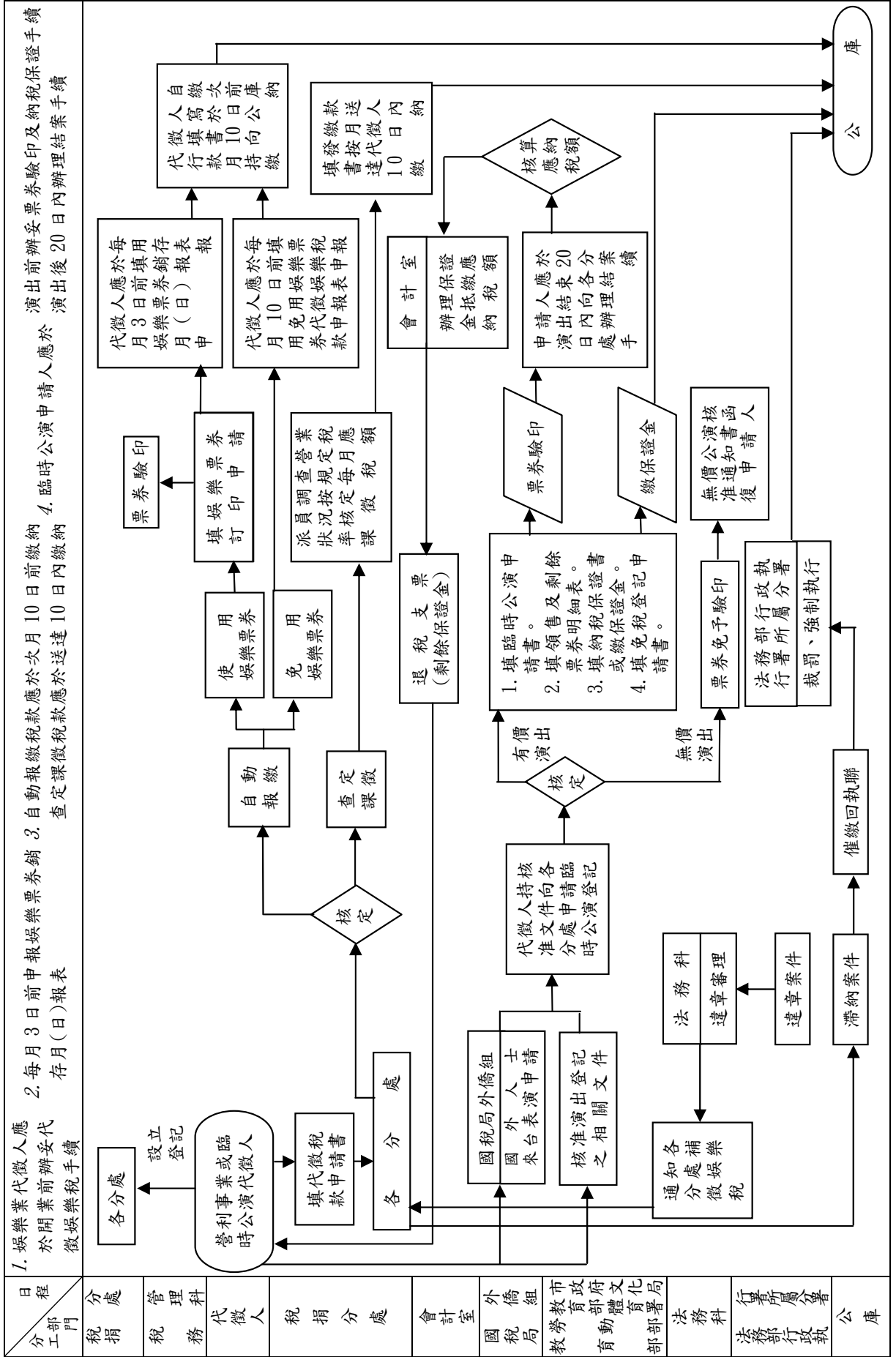
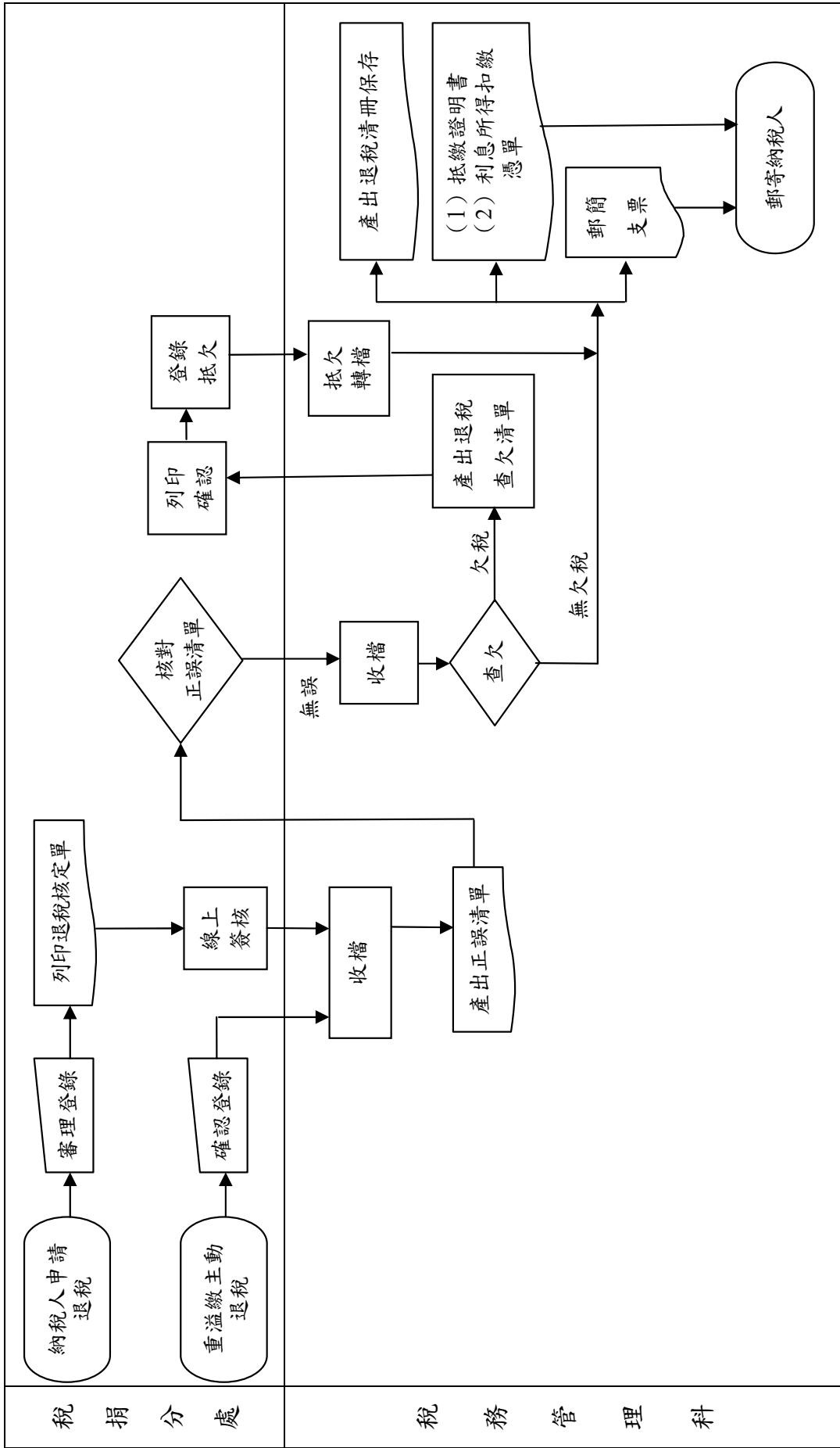
### IV . Administrative Organization



## 一、沿革

民國 34 年全省實施統一稽徵制度，臺北市設第一、第二稅務稽徵所管轄本市稅捐稽徵業務，民國 36 年 1 月合併成立臺北市稅捐稽徵處，下設 6 課及城中、中山、延平、萬華、古亭、松山等分處，掌理國、省、地方稅捐稽徵事宜，在系統上隸屬於臺北市政府而受臺灣省政府財政廳指揮監督。

民國 56 年 7 月臺北市改制為直轄市，財政部同時成立臺北市國稅局（102 年更名為財政部臺北國稅局）負責國稅之徵收，本處負責直轄市稅捐稽徵，並同時增設建成分處。民國 57 年 7 月，將市郊景美、木柵、南港、內湖及陽明山管理局之士林、北投等 6 鄉鎮正式劃入為臺北市管轄，除士林、北投另成立為陽明山管理局稅捐稽徵處外，景美、木柵 2 區成立景美分處，南港、內湖 2 區成立南港分處，隸屬於本處。民國 60 年 7 月，因大安區發展迅速，為加強便民服務，由古亭分處撥出成立大安分處。民國 63 年 1 月，原陽明山管理局稅捐稽徵處改隸本處，改設為士林分處。民國 75 年 1 月建成分處併入延平分處，士林分處劃出成立北投分處。民國 77 年 6 月增設內湖及大同 2 個分處。

民國 80 年 7 月，配合臺北市行政區調整為 12 區，本處按行政區域及業務情況設置 13 個分處，分別為中正（城中、古亭合併）、中北、中南（中山分出）、北投、萬華、信義（松山分出）、大安、松山、南港、文山（景美更名）、士林、內湖、大同（延平併入）等分處，就近為市民提供最便捷的納稅服務。

民國 88 年營業稅改制為國稅，仍由本處代徵，10 月為落實組織精簡，提升組織效能，實施組織重整並彈性調整各分處內部架構，業務量較大之大安、中南、中北、松山 4 個分處改設 5 個股，業務量較小之北投、內湖、南港、文山 4 個分處改設 3 個股，其餘大同、中正、信義、萬華、士林等 5 分處仍設 4 個股，並將娛樂稅、印花稅稽徵業務改由分處辦理。

民國 92 年 1 月營業稅移撥由財政部臺北市國稅局稽徵。本處負責房屋稅、地價稅、土地增值稅、契稅、使用牌照稅、娛樂稅、印花稅等地方稅及工程受益費之稽徵。同時重新訂定組織架構，將總處調整為 5 科 5 室，分處仍維持不變，除大安分處設置 4 個股外，其餘分處設置 3 個股。為因應業務需要增設第 2 位副處長職位，於 94 年 1 月正式派任。

民國 95 年 1 月為擴增服務據點，使用牌照稅業務比照其他稅目，將稽徵作業之執行改由分處辦理，人員配合移撥分處。松山分處因牌照稅業務量及員額配置較多，專設 1 股辦理該項業務，改置為 4 個股，至民國 100 年 9 月為配合使用牌照稅稽徵業務回歸機會稅科管理，復調整為 3 個股。民國 104 年士林分處因業務量及員額配置增加，改置 4 個股。

# 臺北市稅捐稽徵處暨所屬各分處稽徵區域圖

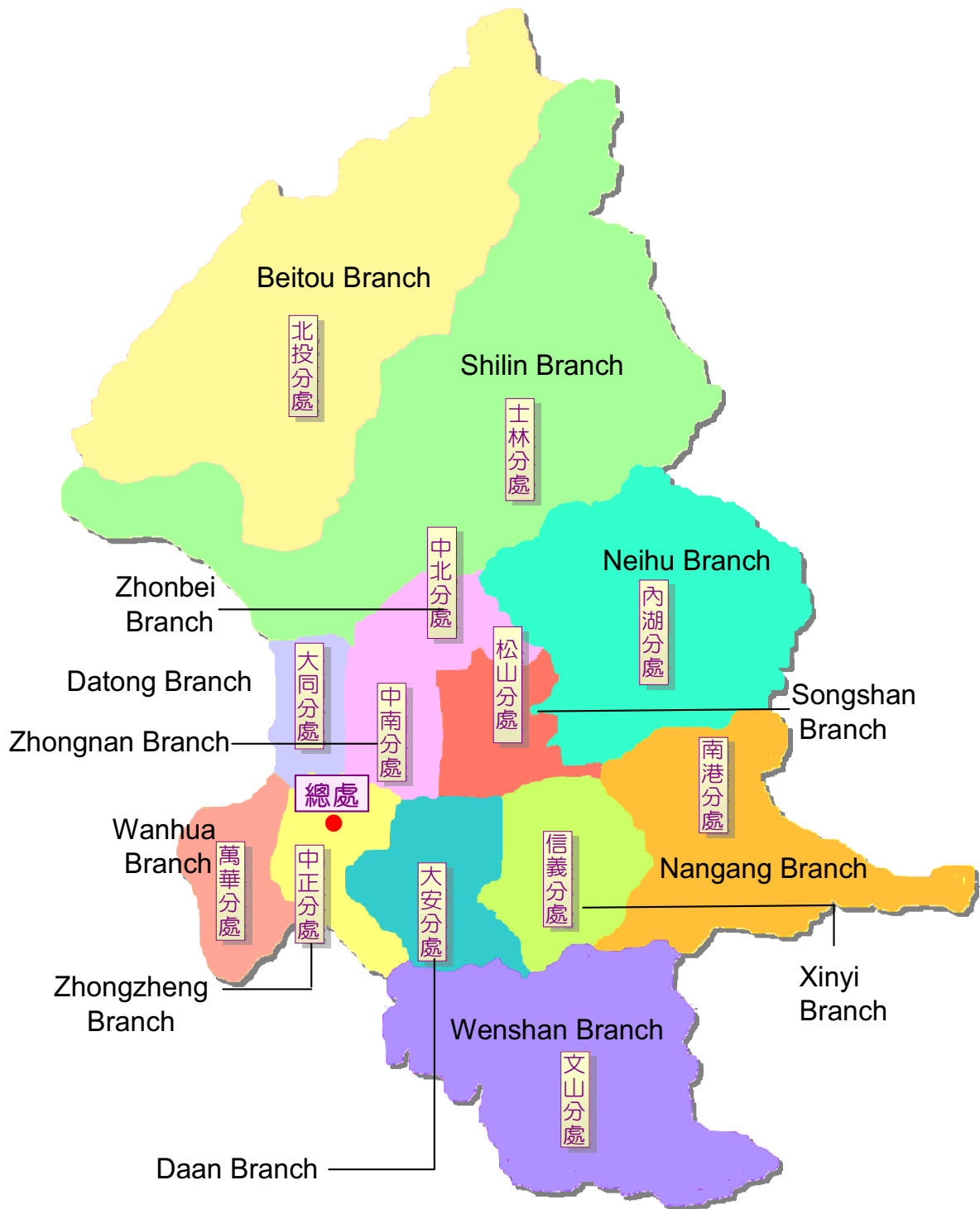

## 二、組織

### 本處組織：

依據臺北市政府 93 年 7 月 30 日府法三字第 09312725300 號令，「臺北市稅捐稽徵處組織規程」核定本處隸屬於臺北市政府財政局，置處長 1 人，綜理處務，並置副處長 2 人襄理處務，下設 5 科 5 室及 13 個分處掌理各項地方稅捐稽徵業務。

# 臺北市稅捐稽徵處組織圖

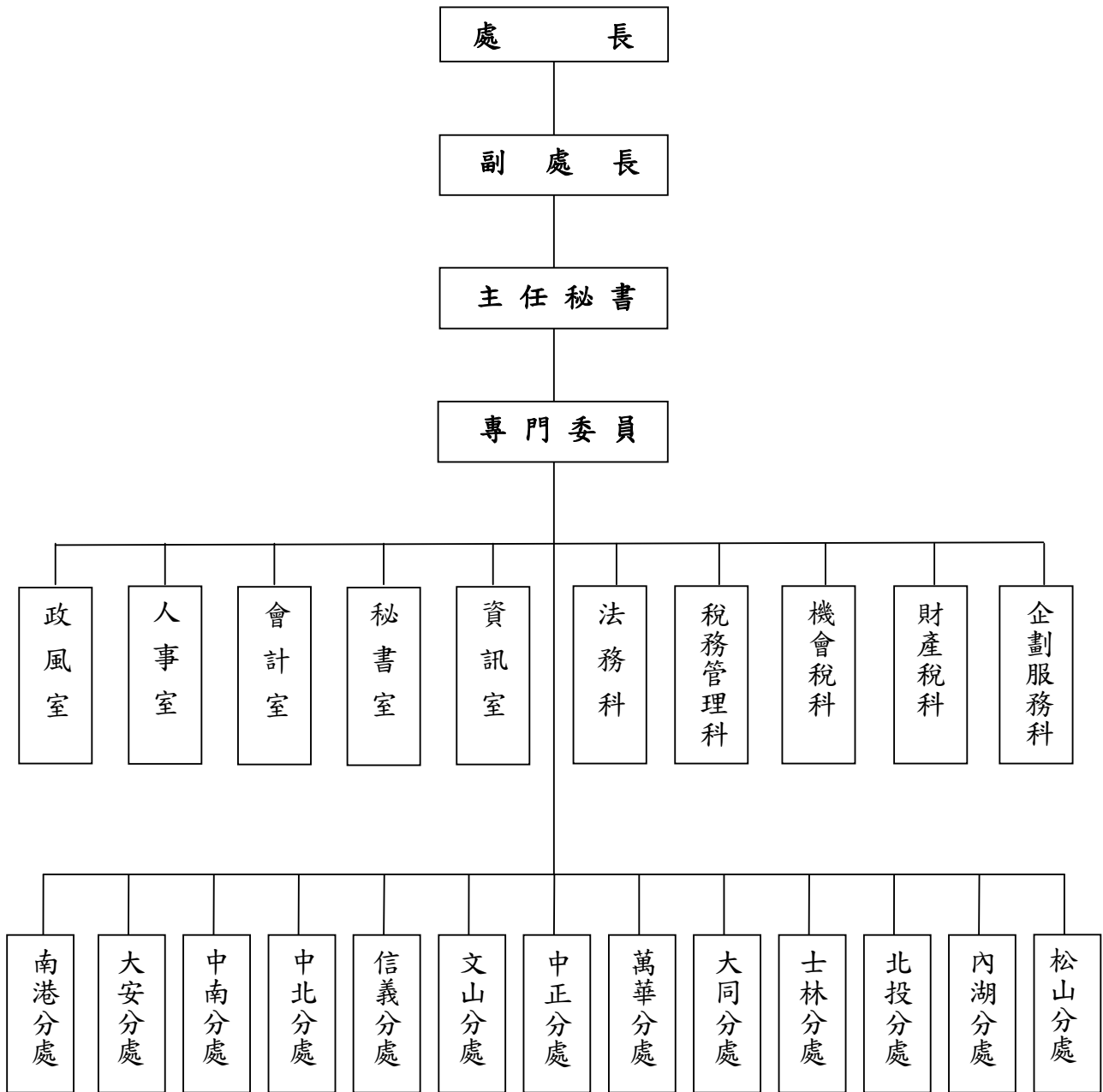

### 三、人事

本處奉准編制員額 846 人，民國 104 年 12 月底現有職員 732 人。現有人員按學歷別分析，研究所畢業者 75 人占 10.3%，大專畢業者 615 人占 84%，高中(職)畢業者 41 人占 5.6%，國中畢業者 1 人占 0.1%；按考試及格別來看，其中高等考試及格者 178 人占 24.3%，普通考試及格者 80 人占 10.9%，特種考試及格者 312 人占 42.6%，升等考試及格者 99 人占 13.6%，初等考試及格者 35 人占 4.8%，其他考試及格者 25 人占 3.4%，依其他法令進用者 3 人占 0.4%；按年齡別分，20 歲至 29 歲 108 人占 14.8%，30 歲至 39 歲 178 人占 24.3%，40 歲至 49 歲 218 人占 29.8%，50 歲至 59 歲 198 人占 27%，60 歲以上 30 人占 4.1%，平均年齡為 42.46 歲。



表 19 本處人事概況  
(一)法定員額與現有員額  
104年12月底

單位：人

職 稱	Position	法定員額 Budget Staff		現有員額 Actual Staff	備 註	
		職 等	員 額			
總 計	Total		846	732	本表法定員額係奉 臺北市政府 93 年 7 月 30 日府法三字第 09312725300 號令核 定之員額。	
處 長	Director	第 十 一 職 等	1	1		
副 處 長	Deputy Director	第 十 職 等	2	2		
主 任 秘 書	Chief Secretary	第 九 職 等	1	1		
專 門 委 員	Senior Specialist	第 九 職 等	2	1		
科 長	Section Chief	第 八 職 等	5	5		
分 處 主 任	Manager, Branch	第 八 至 九 職 等	13	13		
主 任	Chief	第 八 職 等	2	2		
秘 書	Secretary	第 七 至 八 職 等	3	3		
督 導	Inspector	第 七 至 八 職 等	3	1		
審 核 員	Revenue Assessor	第 七 至 八 職 等	19	19		
專 員	Specialist	第 七 至 八 職 等	1	1		
股 長	Sub-section Chief	第 七 職 等	62	61		
分 析 師	Systems Analyst	第 七 職 等	2	2		
設 計 師	Systems Designer	第 五 或 六 至 七 職 等	14	13		
管 理 師	Systems Coordinator	第 五 或 六 至 七 職 等	4	4		
助 理 設 計 師	Assistant Systems Designer	第 三 至 五 職 等	6	4		
助 理 管 理 師	Assistant Systems Coordinator	第 三 至 五 職 等	1	1		
稅 務 員	Revenue Officer	第 五 或 六 至 七 職 等	344	318		
助 理 稅 務 員	Revenue Assistant	第 三 至 五 職 等	167	146		
科 員	Section Assistant	第 五 或 六 至 七 職 等	6	6		
辦 事 員	Senior Clerk	第 三 至 五 職 等	19	18		
書 記	Clerk	第 一 至 三 職 等	124	70		(內 3 人俟雇員出 缺後改置)

續下頁

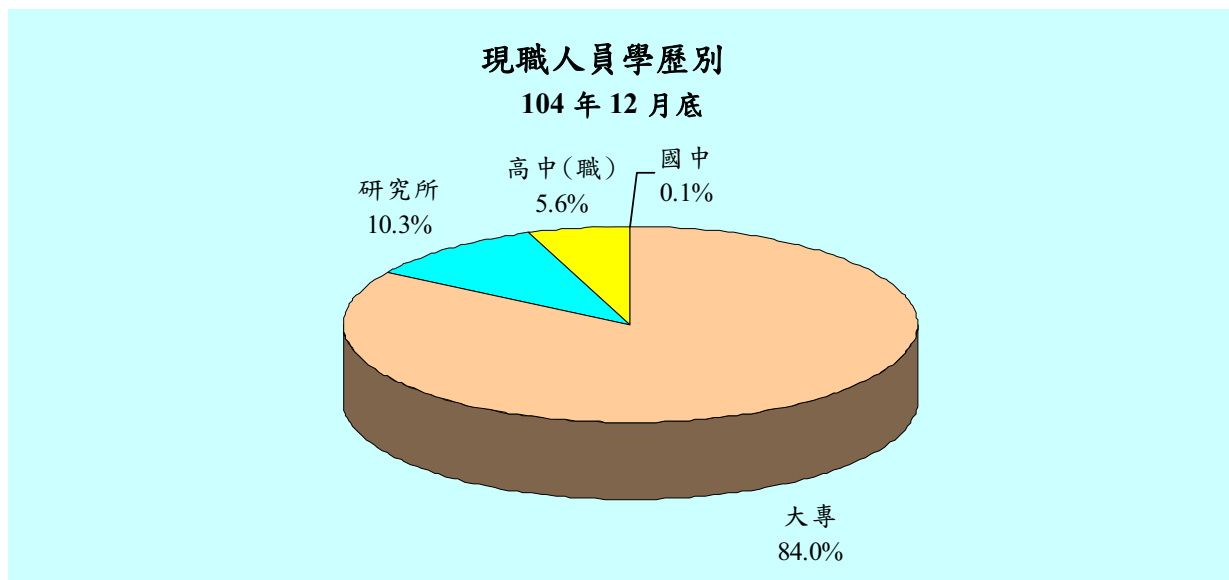
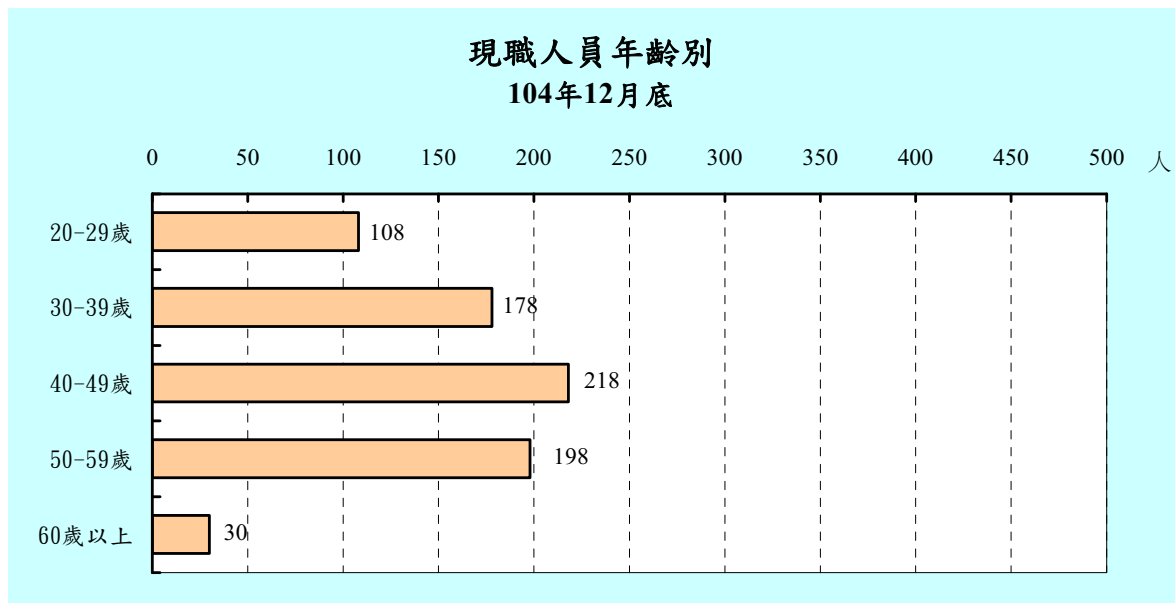
表 19 本處人事概況(續 1)

(一)法定員額與現有員額

104 年 12 月底

單位：人

職 稱 Position	法定員額 Budget Staff		現有員額 Actual Staff	備 註	
	職 等	員 額			
會計室 Accounting office	會計主任 Chief Accounting Officer	第 八 職 等	1	1	
	專員 Specialist	第 七 至 八 職 等	1	1	
	股長 Sub- section Chief	第 七 職 等	4	4	
	科員 Section Assistant	第 五 或 六 至 七 職 等	11	11	
	辦事員 Senior Clerk	第 三 至 五 職 等	1	1	
	書記 Clerk	第 一 至 三 職 等	2	—	
	人 事 室 Personnel Office	主任 Chief Personnel Officer	第 八 職 等	1	1
專員 Specialist		第 七 至 八 職 等	1	1	
股長 Sub- section Chief		第 七 職 等	3	3	
科員 Section Assistant		第 五 或 六 至 七 職 等	8	7	
助理員 Assistant		第 四 至 五 職 等	2	2	(內 1 人得列 薦任)
書記 Clerk		第 一 至 三 職 等	1	1	
政 風 室 Government Ethics Office		主任 Chief Government Ethics Officer	第 八 職 等	1	1
	股長 Sub- section Chief	第 七 職 等	2	2	
	科員 Section Assistant	第 五 或 六 至 七 職 等	4	4	
	辦事員 Senior Clerk	第 三 至 五 職 等	1	—	
	書記 Clerk	第 一 至 三 職 等	1	—	

附註：根據本處人事室資料編製。

## 表 19 本處人事概況(續 2)

(二) 年齡與職等、性別

104 年 12 月底

單位：人

年 齡 age	官 等 Official Classes					性 別 Sex		
	共 計 Total	10-14 職等 Selected Appointment	6-9 職等 Recommended Appointment	1-5 職等 Delegated Appointment	雇 員 Assistant Clerk	共 計 Total	男 Male	女 Female
<b>總 計</b> <b>Grand Total</b>	<b>732</b>	<b>3</b>	<b>389</b>	<b>337</b>	<b>3</b>	<b>732</b>	<b>138</b>	<b>594</b>
20 歲 - 29 歲	108	—	38	70	—	108	15	93
30 歲 - 39 歲	178	—	88	90	—	178	48	130
40 歲 - 49 歲	218	—	131	87	—	218	33	185
50 歲 - 59 歲	198	1	118	77	2	198	35	163
60 歲 以 上	30	2	14	13	1	30	7	23

## (三) 學歷及考試

104 年 12 月底

單位：人

學 歷 及 考 試 別 Educational & Examination	共 計 Total	10-14 職等 Selected Appointment	6-9 職等 Recommended Appointment	1-5 職等 Delegated Appointment	雇 員 Assistant Clerk
<b>(1) 學 歷 Education</b>	<b>732</b>	<b>3</b>	<b>389</b>	<b>337</b>	<b>3</b>
研 究 所 Graduate School	75	—	57	18	—
大 專 Junior College	615	3	326	284	2
高 中 ( 職 ) Senior High School	41	—	6	34	1
國 ( 初 ) 中 及 以 下 Junior High School and Under	1	—	—	1	—
<b>(2) 考 試 Examination</b>	<b>732</b>	<b>3</b>	<b>389</b>	<b>337</b>	<b>3</b>
高 等 考 試 Senior Civil Service Exam.	178	1	152	25	—
普 通 考 試 Junior Civil Service Exam.	80	—	30	50	—
特 種 考 試 Special Civil Service Exam.	312	1	129	182	—
升 等 考 試 Rank Promotion Service Exam.	99	1	66	32	—
初 等 考 試 Elementary Civil Service Exam.	35	—	—	35	—
其 他 考 試 Other Civil Service Exam.	25	—	10	12	3
依 其 他 法 令 進 用 By Other Means	3	—	2	1	—

表 19 本處人事概況(續 3 完)

(四)年 資

104 年 12 月底

單位：人

年 資 Seniority	共 計 Total	10—14 職等 Selected Appointment	6—9 職等 Recommended Appointment	1—5 職等 Delegated Appointment	雇 員 Assistant Clerk
<b>總 計</b> Grand Total	<b>732</b>	<b>3</b>	<b>389</b>	<b>337</b>	<b>3</b>
5 年 以 下	228	—	93	135	—
6 年— 9 年	99	—	44	55	—
10 年—14 年	81	—	38	43	—
15 年—19 年	85	—	49	36	—
20 年—24 年	132	—	80	50	2
25 年—29 年	51	—	39	12	—
30 年 以 上	56	3	46	6	1

## (五)工 作 類 別

104 年 12 月底

單位：人

工 作 類 別 Job	共 計 Total	10—14 職等 Selected Appointment	6—9 職等 Recommended Appointment	1—5 職等 Delegated Appointment	雇 員 Assistant Clerk
<b>總 計</b> Grand Total	<b>732</b>	<b>3</b>	<b>389</b>	<b>337</b>	<b>3</b>
行 政	68	—	10	58	—
財 政	592	3	337	252	—
人 事	15	—	9	6	—
會 計	18	—	14	4	—
雇 員	3	—	—	—	3
資 訊 處 理	29	—	14	15	—
政 風	7	—	5	2	—
安 全 保 防	—	—	—	—	—

表 20 本處歲出預決算數

單位：新臺幣元

年度及科目別	預 算		決 算		決算數 占預算數 之比率 % (2/1)×100
	金 額 (1)	%	金 額 (2)	%	
95 年 度	929,515,635	100.0	918,257,368	100.0	98.8
96 年 度	917,289,764	100.0	895,615,954	100.0	97.6
97 年 度	923,887,755	100.0	895,044,198	100.0	96.9
98 年 度	925,665,198	100.0	898,324,537	100.0	97.0
99 年 度	910,138,102	100.0	898,108,142	100.0	98.7
100 年 度	924,158,185	100.0	915,283,662	100.0	99.0
101 年 度	926,239,026	100.0	898,931,066	100.0	97.1
102 年 度	937,691,092	100.0	916,073,419	100.0	97.7
103 年 度	928,468,874	100.0	918,028,505	100.0	98.9
104 年 度	974,283,556	100.0	949,010,297	100.0	97.4
一般行政	170,113,915	17.5	167,079,633	17.6	98.2
行政管理	170,113,915	17.5	167,079,633	17.6	98.2
稅捐稽徵業務	754,151,768	77.4	737,285,896	77.7	97.8
財產稅稽徵	362,273,411	37.2	361,053,897	38.0	99.7
機會稅稽徵	66,167,101	6.8	64,306,415	6.8	97.2
稅務管理	223,029,149	22.9	212,207,273	22.4	95.1
違章及行政救濟	16,206,613	1.7	15,787,470	1.7	97.4
電子處理資料	86,475,494	8.9	83,930,841	8.8	97.1
建築及設備	50,017,873	5.1	44,644,768	4.7	89.3
土地購置	1,010,000	0.1	1,010,000	0.1	100.0
營建工程	42,056,866	4.3	38,939,849	4.1	92.6
交通及運輸設備	1,090,000	0.1	190,000	0.0	17.4
其他設備	5,861,007	0.6	4,504,919	0.5	76.9

資料來源：依據審計部臺北市審計處審核決算審定書編製。

附註：1. 本表未包括統籌科目。

2. 104年度決算數尚未經審計部臺北市審計處審定。

中華民國 104 年度  
臺北市稅捐統計年報

出版機關：臺北市稅捐稽徵處

發行人：黃素津

編輯：臺北市稅捐稽徵處會計室

地址：臺北市中正區北平東路 7 之 2 號

電話：(02)23949211 分機 341

網址：[www.tpctax.gov.taipei](http://www.tpctax.gov.taipei)

創刊日期：中華民國 42 年 2 月

出版日期：中華民國 105 年 3 月

出刊頻率：年刊

本刊登載於本處網站

依法納稅是義務

合法節稅是權利

主動退稅是責任



2017 臺北世大運  
UNIVERSIADE ★★★★★  
2017.8.19-8.30



北市稅處  
粉絲團

